

HOME DECORATOR KITS

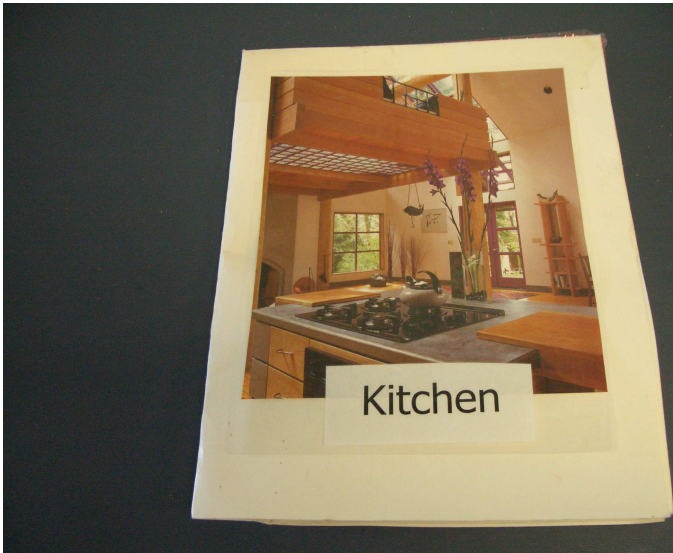

Encourage the resident to look through the book and decide how they would like to decorate a living room, kitchen, bathroom, etc. using the various upholstery, wallpaper, and rug samples in the book. This item is especially useful for women of all functioning levels and seems to reduce agitation by providing a calming sensation. The home decorator book is also wonderful for family visits. The family can talk about the home and how it is decorated.

Cues for this action: “Here is a book with samples of rugs, wallpaper, and upholstery you can use to decorate a room with.” *Demonstrate* -Go through one of the books and choose an upholstery, wallpaper, and rug sample you would like to use to decorate the room with. *Now cue* - “You pick a room and choose how you would decorate it.” Also can just look at the various upholstery, wallpaper, and rug samples and have the resident feel them.

Promotes:

1. Sensory stimulation.
2. Sense of achievement.
3. Reaching & sitting balance.
4. Manual dexterity.

Discussion ideas:

Did you ever own a home?

How many rooms did it have?

Where did you spend most of your time?

HOME DECORATOR KITS

Need:

For this project you will need to select fabrics, carpet and wallpaper swatches that are color-coordinated. Overall pale pastel themes or dark, drab colors should not be used. Bright, cheerful colors are most enjoyable. Look for samples with varied and interesting textures as well as different colors.

- 3 or 4 rectangular or square carpet swatches, each less than 4” x 4”. These generally come attached to a plastic backing and are readily available from carpet stores. The swatches should be of different textures as well as different colors.

- 4 or 5 fabric swatches, different sizes, none larger than 9" x 12", none smaller than about 6" x 9". Each piece of fabric should have a different texture -- satin, velvet, sheer, rough, patterned, ribbed, etc.; flannel-backed vinyl is good for kitchen; terry cloth is good for kitchen and bath room pages; sheer curtain fabric (cut from old nylon curtains) is good for any room. Although some fabrics will ravel, don't hem the pieces.
- 4 or 5 wallpaper (and wallpaper border) swatches, different sizes, none larger than 9 inches x 12 inches. These swatches are cut from pages torn out of a wallpaper book, readily available from home decorating stores.
- 1 tri-fold or bi-fold paint chip folder, no larger than 9" x 11" when folded
- 1 sheet of 22" x 28" poster board
- paper glue or glue stick
- non-shiny cellophane tape (such as Scotch™ magic tape)
- a full-page magazine color photo of a kitchen, living room, bed room or bath room
- microwave oven
- sewing machine
- good fabric-cutting shears

Instructions

Making the folder

Fold the poster board in half and then in half again, as shown, so you have what looks like a 14"x 11" giant greeting card. We will be using the folder with the open side at the top.

Press the folds flat with your thumbnail or the side of a ball-point pen or butter knife to make sure the creases are crisp.

First, the Carpet Samples

1. Remove the carpet sample swatches from their plastic display card. Leave the dried glue on the carpet pieces. If the majority of the glue remains on the plastic display card, peel some glue off the plastic and keep it.

2. Arrange the carpet swatches on the poster board folder as shown. Place excess glue "chunks" (that you peeled off the plastic) between the carpet pieces and the poster board.

3. Lay the poster board folder in the microwave oven with the carpet swatches placed correctly. Heat for 4 minutes at full power. The glue will soften and attach the swatches firmly to the poster board. When you take the folder out of the microwave oven, press the swatches onto the poster board firmly with your hands.

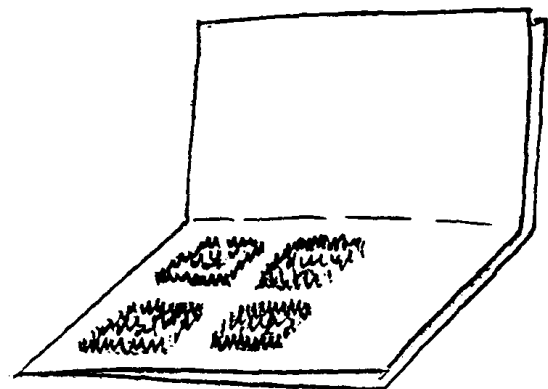
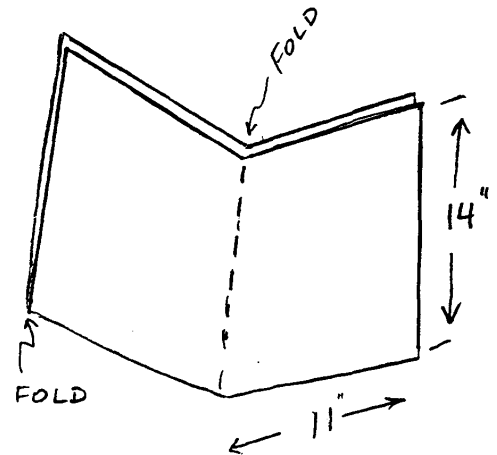

Second, the Wallpaper Swatches

1. Tear out four or five pages and borders from a wallpaper sample book.
2. Cut out rectangular pieces, 9" x 12" and smaller (exact sizes not important, but they shouldn't be too small.)
3. Using a sewing machine set on its largest straight stitch, sew the pieces together across the top, forming a "stack" as shown.
4. On the same page as the carpet swatches, sew the sewn-together wallpaper stack to the double layer of poster board, sewing next to the previous stitching line, reinforcing the stitching at the beginning and end, as shown.

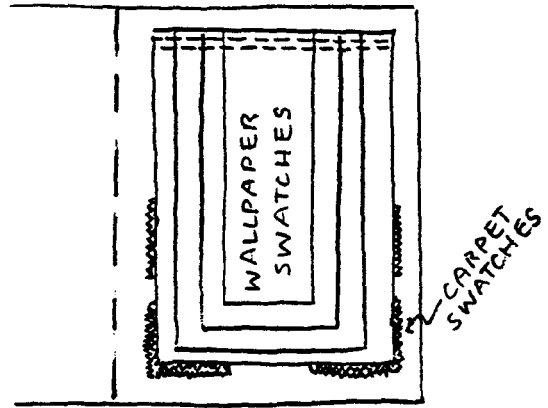

Third, the Fabric Swatches

1. Cut the assortment of fabrics into rectangles 9" x 12" or less as you did the wallpaper samples.
2. Stack them the same way as you did the wallpaper and sew the stack of fabric swatches across the top. You should pin them first because they tend to be slippery.
3. Using the same stitch setting as you did with the wallpaper, sew the fabric stack to the left-hand page of the decorator folder (through both layers of poster board), reinforcing the stitching at the beginning and the end, as shown.

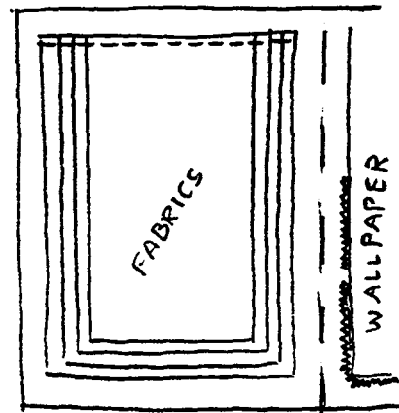

Fourth, the Paint Sample Sheet

1. Flip back the fabric swatches and glue the folded paint sample sheet to the bottom left hand of the decorator folder as shown.
2. Tape the top and bottom of the center page of the paint sample sheet to the poster board for extra fastening security.

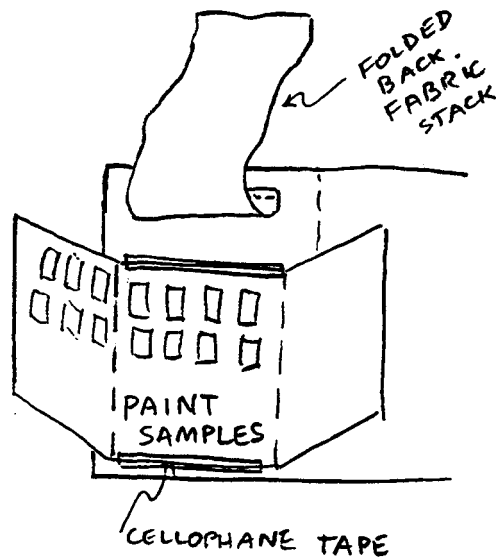

Finally, the Cover

1. Cut out the appropriate room name label. Glue and tape it to the cover, as shown.
2. Glue a full-page color magazine photograph of a kitchen, bedroom, living room, or bathroom (as appropriate) to the cover. Tape around all the edges of the photograph



Instructions

Making the Folder

Fold the poster board in half and then in half again, as shown, so you have what looks like a 14" x 11" giant greeting card. We will be using the folder with the open side at the top. Press the folds flat with your thumbnail or the side of a ballpoint pen or butter knife to make sure the creases are crisp.

First, the Carpet Samples

1. Remove the carpet sample swatches from their plastic display card.
2. Select a 9" x 9" neutral color piece of sturdy fabric. Using a big zig-zag stitch sew the piece of fabric onto the poster board as shown.
3. Glue the carpet samples to the fabric. Make sure they are securely attached because people will be trying to pull them off.

Second, the Wallpaper Swatches

1. Cut out four or five pages and borders from a wallpaper sample book.
2. Cut out rectangular pieces, 9" x 12" and smaller (exact sizes not important, but no piece should be smaller than 4" x 7")
3. The back of each piece of wallpaper must be reinforced at the top corners with strapping tape and totally backed with clear (or white) Contac™ paper as shown.
4. Using a sewing machine set on its largest straight stitch, sew the pieces of wallpaper together across the top, forming a "stack" as shown.
5. On the same page as the carpet swatches, sew the sewn-together wallpaper stack to the double layer of poster board, sewing next to the previous stitching line, reinforcing the stitching at the beginning and end, as shown.

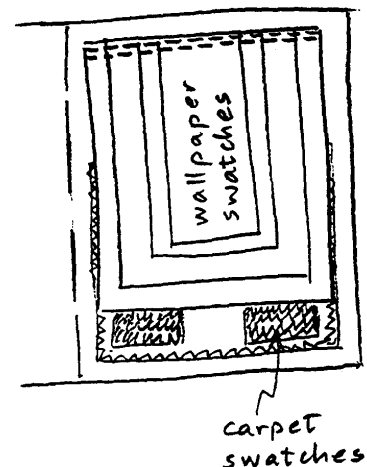
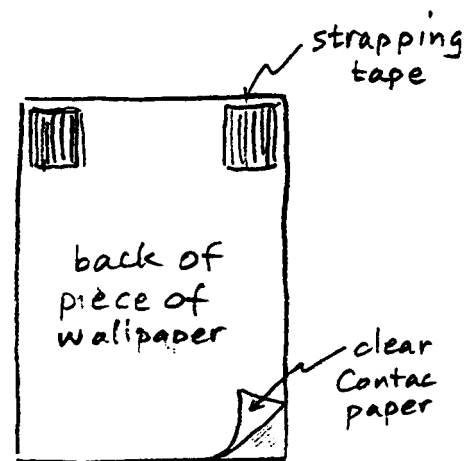
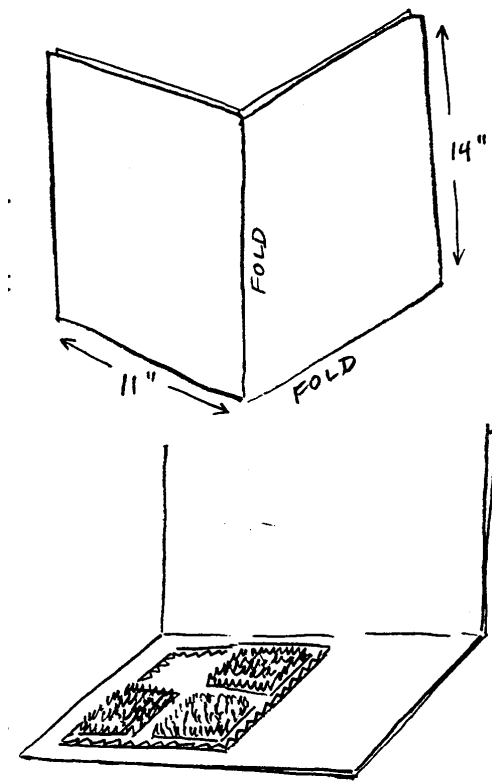

Third, the Fabric Swatches

1. Cut the assortment of fabrics into rectangles 9" x 12" or less as you did the wallpaper samples.
2. Stack them the same way as you did the wallpaper and sew the stack of fabric swatches across the top. You should pin them first because they tend to be slippery. The fabric pieces do not need to be reinforced with tape or Contac™ paper.
3. Using the same stitch setting as you did with the wallpaper, sew the fabric stack to the left-hand page of the decorator folder (through both layers of poster board), reinforcing the stitching at the beginning and the end, as shown.

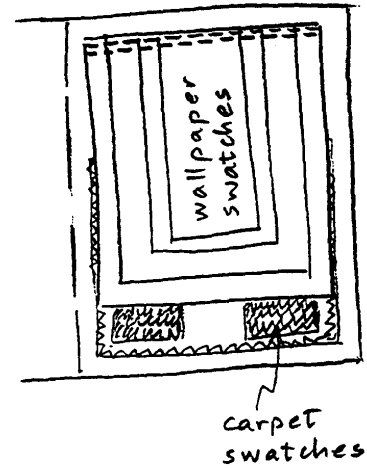

Fourth, the Paint Samples

1. Flip back the fabric swatches and tape the paint chips to the bottom left hand of the decorator folder as shown, covering the chips completely with clear tape or clear Contac™ paper.

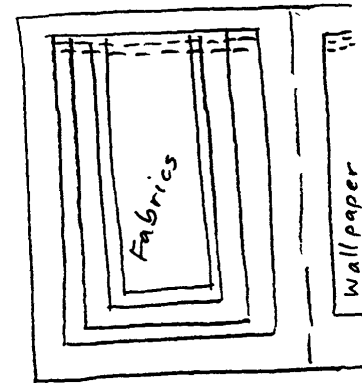

Finally, the Cover

1. Cut out the appropriate room name label. Glue and tape it to the cover, as shown.
2. Glue a full-page color magazine photograph of a kitchen, bedroom, living room, or bathroom (as appropriate) to the cover. Tape around all the edges of the photograph. Many wallpaper books have color photos of rooms using the wallpaper patterns you have chosen. These photos make nice covers.



Buettner, L. & Greenstein, D. (1997). Simple Pleasures: A multi-level sensorimotor intervention for nursing home residents with dementia. (Training manual and instructions)