

Residential Onsite Wastewater Treatment Systems

Design Handbook



New York State Department of Health
Bureau of Water Supply Protection

2012

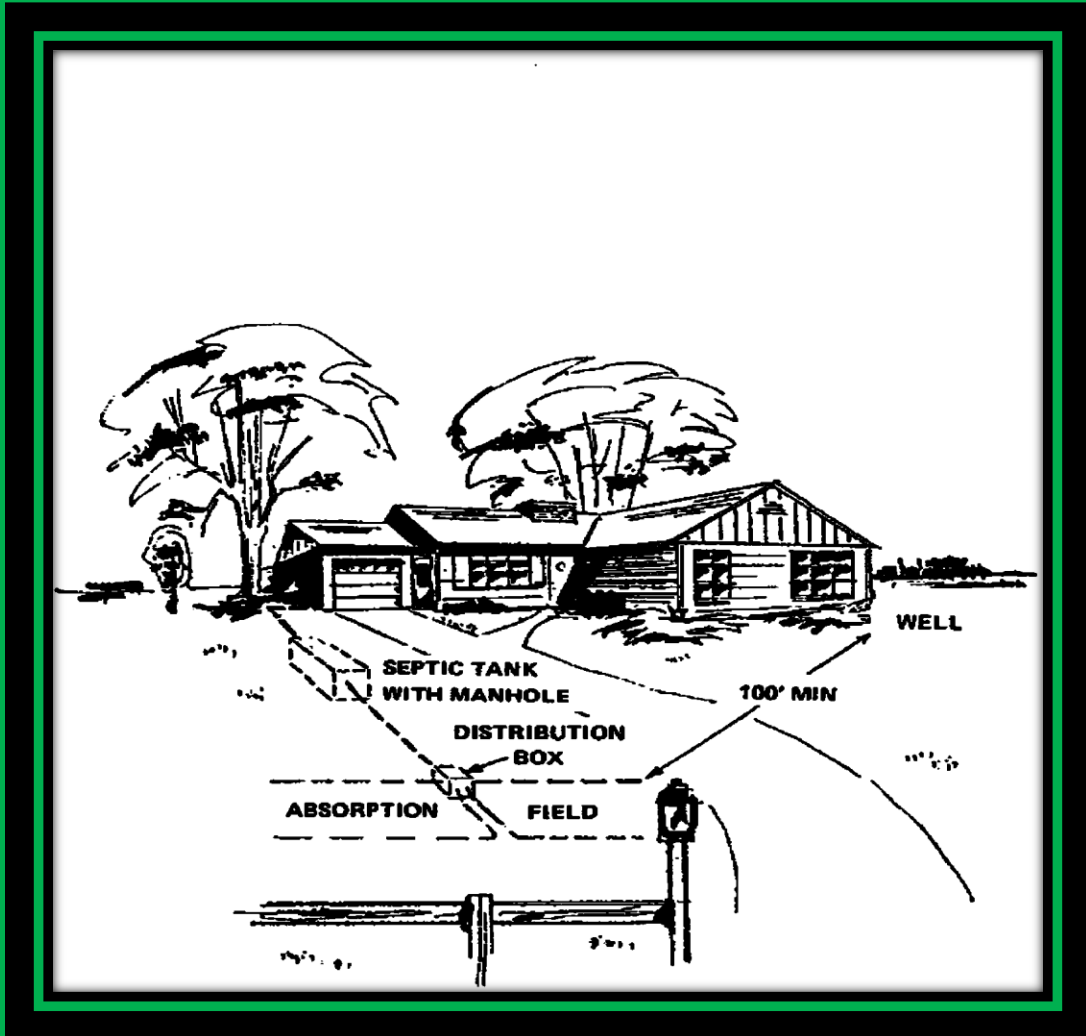

**“WASTE TREATMENT HANDBOOK
INDIVIDUAL HOUSEHOLD SYSTEMS”
1976**

This diagram is for historical interest only. Do not use for plan or design preparation.

Residential Onsite Wastewater Treatment Systems

Design Handbook



**New York State Department of Health
Bureau of Water Supply Protection
2012
(Previous V. 1996)**

For an copy of this Handbook go to:

http://www.health.ny.gov/environmental/water/drinking/wastewater_treatment_systems/design_handbook.htm

THE DISPOSAL OF HUMAN EXCRETA AND SEWAGE OF THE COUNTRY HOME

THEODORE HORTON, C. E.

Director, Division of Sanitary Engineering

The disposal of human excreta and sewage at the country home in a manner that is safe and at the same time convenient and simple, has always presented some difficulties. This is due to the fact that success depends not alone upon the selection of proper methods, and upon good construction, but equally, if not more so, upon proper care and maintenance.

Much has been written and published on this subject, including many circulars and bulletins of National and State Boards of Health, Colleges of Agriculture, etc.; and whereas much of this literature is interesting and instructive, unfortunately much of it is impractical, erroneous and ill-advised. Many absurd, and in some cases absolutely insanitary schemes have been offered. Some of these indicate a lack of knowledge of correct principles and of a proper perspective of the sanitary requirements to be fulfilled; others, an entire disregard of the limitations of human nature in performing acts or duties connected with the maintenance of the various devices; still others, an erroneous and futile attempt to develop a single device or type of disposal which is universally applicable.

It is with no idea of adding materially new information on this subject that the present bulletin is offered, but to endeavor to create a more correct perspective of the subject, to caution against some of the erroneous ideas and schemes advanced or to be inferred from the mass of information now before the public, and above all to emphasize the desirability if not necessity of breaking away from the many somewhat costly and complex devices which have been frequently advanced by zealous enthusiasts, or exploited by commercial concerns, and of returning to the simpler and more practicable devices or methods which can be installed with plain labor, which are economical in construction and which can be maintained in a sanitary manner by simple means.

In dealing with this subject the first question that should be considered is as to what constitutes a sanitary method of disposal of excreta and to this question we may, without entering into any elaborate discussion, answer by the following requirements:

- 1 It should not give rise to a nuisance, i. e., should not offend the senses in any way.
- 2 It should not be a menace to health, i. e., not be a means of transmission to human beings of any disease germs which may be present in the excretal discharges.
- 3 It should be located conveniently to the house.
- 4 It should be free from esthetic objections in regard to its location, condition during use, or manner and means of maintenance.
- 5 Its operation should not be affected by freezing weather.

“The Disposal of Human Excreta and Sewage of the Country Home”

Theodore Horton, C.E., Director of Sanitary Engineering

NYSDOH

Published October 5, 1916

This text is for historical interest only. Do not use for plan or design preparation.

Included throughout this Handbook are several examples of diagrams, tables and text from archival Department documents that dealt with onsite wastewater treatment system (OWTS) design and policy. These examples trace the development of OWTS technology innovations and Department policy development, which led to increased protection of public health and the environment. These examples are a small testimony to the significant foresight, expertise and professionalism of Department and industry personnel who were leaders in OWTS innovation, technology and policy, both in the past and more recently, not only in New York State, but also nationally and in some cases internationally.

Table of Contents

List of Acronyms	12
Chapter 1: Foreword	13
1.1 Regulation by Other Agencies and Local Authorities	14
1.2 Acknowledgement.....	14
1.3 Introduction	15
Chapter 2: Construction Safety	17
2.1 General Trenching and Excavation Safety Guidance.....	17
Chapter 3: Wastewater Flows	19
3.1 Water Softener Discharges	20
3.2 Low Flow Fixtures	20
3.3 Spas, Whirlpool Baths, Hot Tubs and High Water Use Products	21
3.4 Protecting the Onsite Wastewater Treatment System	21
Chapter 4: Soil and Site Appraisal	23
4.1 Purpose.....	23
4.2 Site Investigation.....	23
4.3 Separation Requirements.....	23
4.4 Selecting Drinking Water Well Location	24
4.5 Soil Investigation.....	25
4.5.1 Soil Investigation for Seepage Pits	27
4.6 Soil Identification	27
4.7 Soil Percolation	28
4.7.1 Soil Percolation Testing	29
4.7.2 Soil Percolation Test Procedure	29
4.7.3 Seepage Pit Percolation Tests.....	30
Chapter 5: House Sewer Drain	31
5.1 General Information	31
5.2 Separation Between Water Supply Lines and House Sewers Drains	31
Chapter 6: Septic Tanks	33
6.1 General Information	33
6.2 Effluent Filters.....	34
6.3 Septic Tank Location.....	34
6.4 Septic Tank Design and Installation.....	35
6.5 Multi-Compartment Tanks or Tanks In-Series	36

6.6 Pre-cast Reinforced Concrete Septic Tanks	37
6.7 Cast-in-place Concrete Septic Tanks	38
6.8 Fiberglass and Polyethylene Septic Tanks	38
6.9 Steel Septic Tanks	38
6.10 Septic Tank Certification and Water Tightness Testing	39
6.10.1 Vacuum Testing	39
6.10.2 Water Pressure Testing.....	39
6.11 Operation and Maintenance of Septic Tanks	39
6.11.1 Septic Tank Inspections and Cleaning	40
6.11.2 Septic Tank Additives	40
6.12 Grease Traps	40
6.13 Abandoning/Decommissioning Septic Tanks	41
Chapter 7: Enhanced Treatment Units (ETUs)	43
7.1 General Information	43
7.2 ETUs for New Construction	43
7.3 ETUs for Repair or Replacement	44
7.4 Operation and Maintenance of ETUs	45
Chapter 8: Wastewater Distribution and Devices	47
8.1 General Information	47
8.2 Distribution Box	47
8.3 Serial Distribution	48
8.4 Drop Boxes	48
8.5 Pressure Distribution	49
8.6 Dosing	50
8.7 Timed Dosing	51
8.8 Pump or Siphon Chambers	51
Chapter 9: Subsurface Onsite Wastewater Treatment Systems	53
9.1 General Information	53
9.1.1 Nutrients (Phosphorus and Nitrogen).....	53
9.1.2 Nitrogen Reducing ETUs	54
9.2 Absorption System Location	54
9.3 Subsurface Drainage and Water Table Control	55
9.4 Stabilization of Disturbed Soil and Fill Material	56
9.5 Choice of Onsite Wastewater Treatment Systems	57
9.6 Site Modifications to Accommodate Onsite Wastewater Treatment Systems	58
9.6.1 Clay Barrier Protecting Bedrock Recharge Aquifers	58

9.6.2 Limited Surficial Useable Soil	58
9.6.3 Very Fast Percolating Soils	59
9.6.4 Sloping Sites	59
9.6.4.1 In-situ Absorption Trenches on Sloped Sites	60
9.7 Specific Waivers or Other Local Approvals.....	61
9.8 Materials Used In Onsite Wastewater Treatment Systems	61
9.8.1 Alternate Aggregate	62
9.8.2 Tire Derived Aggregate (TDA)	62
9.9 Conventional Absorption Trench Systems	63
9.9.1 General Information	63
9.9.2 Site Requirements	63
9.9.3 Design Criteria	63
9.9.4 Construction	64
9.10 Gravelless Absorption Trench Systems	65
9.10.1 General Information	65
9.10.2 Site Requirements	65
9.10.3 Design Criteria	65
9.10.3.1 Open-Bottom Gravelless Chambers.....	66
9.10.3.2 Media-Wrapped Corrugated Pipe Sand-lined Systems	66
9.10.3.3 Gravelless Geotextile Sand Filter Systems.....	66
9.10.4 Construction	66
9.11 Deep Absorption Trenches	67
9.11.1 General Information	67
9.11.2 Site Requirements	67
9.11.3 Design Criteria	67
9.11.4 Construction	67
9.12 Shallow Absorption Trenches	68
9.12.1 General Information	68
9.12.2 Site Requirements	68
9.12.3 Design Criteria	68
9.12.4 Construction	69
9.13 Cut and Fill Systems	69
9.13.1 General Information	69
9.13.2 Site Requirements	70

9.13.3 Design Criteria	70
9.13.4 Construction	70
9.14 Absorption Bed Systems	71
9.14.1 General Information	71
9.14.2 Site Requirements	71
9.14.3 Design Criteria	71
9.14.4 Construction	72
9.15 Seepage Pits	72
9.15.1 General Information	72
9.15.2 Site Requirements	73
9.15.3 Design Criteria	73
9.15.4 Construction	75
Chapter 10: Alternative Subsurface Onsite Wastewater Treatment Systems	77
10.1 General Information	77
10.2 Raised Systems	77
10.2.1 General Information	77
10.2.2 Site Requirements	77
10.2.3 Design Criteria	78
10.2.3.1 Raised System Receiving ETU Effluent	79
10.2.4 Construction	79
10.3 Mounds	80
10.3.1 General Information	80
10.3.2 Site Requirements	81
10.3.3 Design Criteria	81
10.3.4 Construction	84
10.4 Intermittent Sand Filters	85
10.4.1 General Information	85
10.4.2 Site Requirements	85
10.4.2.1 Downstream Modified Mound	86
10.4.2.2 Downstream Modified Shallow Trench System.....	86
10.4.3 Intermittent Sand Filter – Design Criteria	86
10.4.3.1 Downstream Modified Mound – Design Criteria	88
10.4.3.2 Downstream Modified Shallow Trench – Design Criteria	89
10.4.4 Intermittent Sand Filter - Construction	89

10.4.4.1 Downstream Modified Mound – Construction	90
10.4.4.2 Downstream Modified Shallow Trench – Construction	90
Chapter 11: Other Onsite Wastewater Treatment or Wastewater Management Systems	91
11.1 Holding Tanks	91
11.2 Non-Waterborne Systems	92
11.2.1 General Information	92
11.2.2 Composters	92
11.2.3 Chemical and Recirculating Toilets	93
11.2.4 Incinerator Toilets	93
11.2.5 Privies and Outhouses	93
Chapter 12: Operation and Maintenance Onsite Wastewater Treatment Systems	95
12.1 Inspection & Maintenance of OWTS Components	95
12.1.1 Septic Tanks	95
12.1.2 Enhanced Treatment Units (ETU)	96
12.1.3 Distribution Devices	96
12.1.4 Pump and Siphon Systems	97
12.1.5 Absorption Facilities	97
Chapter 13: Addressing System Failure	99
13.1 Common Reasons for System Failure	99
13.2 Common Reasons for System Overloading	99
13.3 Common System Design or Installation Mistakes	99

List of Figures

Figure 1: Absorption System Separation Requirements	103
Figure 2: Seepage Pit Separation Requirements	104
Figure 3: Soil Percolation Test	105
Figure 4: House Plumbing, Venting and House Sewer Drain Connection to Septic Tank	106
Figure 5: Typical Septic Tank	107
Figure 6: Effluent Filters and Septic Tank Outlet Enhancements	108
Figure 7: Typical Dual Compartment Septic Tank	109
Figure 8: Example Enhanced Treatment Unit – Suspended Growth (aerated)	110
Figure 9: Example Enhanced Treatment Unit – Attached Growth (media)	111
Figure 10: Distribution Box Detail	112
Figure 11: Serial Distribution Detail	113
Figure 12: Drop Box Detail	114
Figure 13: Typical Dosing Chamber With Siphon	115
Figure 14: Typical Dosing Chamber With Pump	116
Figure 15: End Manifold Pressure Distribution Network	117
Figure 16: Central Manifold Pressure Distribution Network	118
Figure 17: Conventional Absorption Trench Detail	119
Figure 18: Distribution Lateral Spacing for Absorption Trench or Bed	120
Figure 19: Curtain Drain - Cross Section	121
Figure 19A: Curtain Drain Upslope of Wastewater Absorption System - Plan View	122
Figure 19B: Curtain Drain Outlet	123
Figure 20: Example Open - Bottom Gravelless Chamber	124
Figure 21: Example Gravelless Geotextile Sand Filter Systems	125
Figure 22: Example Gravelless Media-Wrapped Corrugated Pipe Sand-Lined System	126
Figure 23: Deep Absorption Trenches	127
Figure 24: Shallow Absorption Trench System – End View	128
Figure 25: Cut and Fill System	129
Figure 26: Absorption Bed System	130
Figure 27: Typical Seepage Pit	131
Figure 28: Raised System - Top View	132
Figure 29: Raised System - Cross Section for Gravity Distribution, Pressure Distribution or Dosing.....	133
Figure 30: Typical Mound - Cross Section with Absorption Trenches	134
Figure 30A: Typical Mound Dimensions - Top View - Absorption Trenches	135

Figure 31: Typical Mound - Cross Section with Absorption Bed	136
Figure 31A: Typical Mound Dimensions - Top View - Absorption Bed.....	137
Figure 32: Typical Mound Dimensions – Side View	138
Figure 32A: Typical Mound Dimensions – Cross Section – Absorption Trench.....	139
Figure 32B: Typical Mound Dimensions – Cross Section – Absorption Bed.....	140
Figure 33: Typical Buried Intermittent Sand Filter	141
Figure 34: Downstream “Modified” Mound	142
Figure 35: Downstream “Modified” Shallow Absorption Trench System	143
Figure 36: Observation Port Detail – Conventional Trench	144
Figure 37: Site Modification for Very Fast Percolating Soils	145
Figure 38: Site Modification for Limited Surficial Useable Soil – Top View	146
Figure 38A: Site Modification for Limited Surficial Useable Soil – Side View.....	147

List of Tables

Table 1: Daily Design Flows	151
Table 2: Required Separation Distances from Wastewater Treatment System Components	152
Table 3: Minimum Septic Tank Capacities	153
Table 4: Site Requirements For Design of Residential Onsite Wastewater Treatment Systems	154
Table 5: Nominal Pipe Volume per Lineal Foot	155
Table 6A: Required Length of Conventional Absorption Trench for Standard Daily Design Flows	156
Table 6B: Conventional Absorption Trench Application Rates for Non-Standard Daily Design Flows	156
Table 6C: Adjusted Required Length of Absorption Trench for Standard Daily Design Flows - Qualifying Open-Bottom Gravelless Chambers or Gravelless Media-Wrapped Corrugated Pipe Sand-Lined Systems	157
Table 6D: Adjusted Required Length of Absorption Trench for Standard Daily Design Flows - Gravelless Geotextile Sand Filter Systems	157
Table 6E: – Adjusted Required Length of Absorption Trench for Standard Daily Design Flows - Enhanced Treatment Units (ETU).....	158
Table 7A: Absorption Beds - Required Bottom Area for Standard Daily Design Flows.....	159
Table 7B: Absorption Beds - Required Bottom Area Application Rates for Non-Standard Daily Design Flows	159
Table 8A: Seepage Pits - Required Absorptive Area for Standard Daily Design Flows	160
Table 8B: Seepage Pits (cylindrical) - Dimensions for Required Absorptive Area	160
Table 9: Raised Systems - Minimum Size of Basal Areas Receiving Septic Tank or ETU Effluent.....	161
Table 10: General Waivers In Effect.....	162
Table 11: Evaluating and Correcting System Failure.....	163
Table 12: USDA Soil Texture Classification Graph.....	164

Glossary (Definitions).....165

References and Websites.....173

List of Appendices.....177

Appendix A: Design of Mound Systems and Pressure Distribution Networks Appendix A
Appendix B: NYSDOH Fact Sheets Appendix B
Appendix C: Acceptable Gravelless and Alternate Aggregate Products Appendix C
Appendix D: Percolation Test Instructions and Data Sheet Appendix D
Appendix E: Specific Waiver Application Forms Appendix E
Appendix F: NYSDOH Guide: Septic Systems - Operation and Maintenance Appendix F
Appendix G: Appendix 75-A: Wastewater Treatment Standards – Residential Onsite Systems Appendix G

List of Acronyms

APA	Adirondack Park Agency
ASTM	ASTM International (formerly the American Society for Testing and Materials)
BOD	biochemical oxygen demand
CEO	Code Enforcement Officer
DEC (also NYSDEC)	New York State Department of Environmental Conservation
DOT	New York State Department of Transportation
Department	New York State Department of Health
EGS	effective grain size
EPA (also USEPA)	United States Environmental Protection Agency
ETU	enhanced treatment unit
gpd	gallons per day
gpd/ft²	gallons per day per square foot
gpdpb	gallons per day per bedroom
gpdpp	gallons per day per person
gpf	gallons per flush
gpm	gallons per minute
LHD	local health department
mpi	minutes per inch
NCRS	National Resources Conservation Service
NESC	National Environmental Services Center
NSF	NSF International (formerly National Sanitation Foundation)
NYCDEP	New York City Department of Environmental Protection
NYSDEC (also DEC)	New York State Department of Environmental Conservation
NYSDOH	New York State Department of Health
NYCRR	New York Codes, Rules and Regulations
OSHA	Occupational Safety and Health Administration
OWTS	onsite wastewater treatment system
PCANY	Precast Concrete Association of New York
PE	Professional Engineer
psf	pounds per square foot
psi	pounds per square inch
PVC	poly vinyl chloride
RME	Responsible Management Entity
SED	New York State Education Department
SPDES	State Pollutant Discharge Elimination System
TDA	tire derived aggregate
TSS	total suspended solids
Uc	uniformity coefficient
UL	Underwriters Laboratories, Inc.
USDA	United States Department of Agriculture
USEPA (also EPA)	United States Environmental Protection Agency
WERF	Water Environment Research Foundation
WPA	watershed protection agency

Chapter 1

Foreword

This handbook was produced to provide information and guidance to help uniformly implement the New York State Department of Health’s (NYSDOH) Administrative Rules and Regulations for the design of residential onsite wastewater treatment systems (OWTS) and to promote effective design, construction and maintenance of residential OWTSs by: design professionals, builders, contractors, local community officials, health department officials and homeowners. Residential OWTS design standards are established in 10NYCRR Appendix 75-A, “Wastewater Treatment Standards –Residential Onsite Systems”, dated February 3, 2010. 10NYCRR Part 75, “Standards for Individual Water Supply and Individual Sewage Treatment Systems”, of the NYSDOH’s Administrative Rules and Regulations establishes that Appendix 75-A is the minimum statewide standard for all new residential OWTSs.

This handbook and Appendix 75-A apply to systems discharging residential wastewater flows of 1,000 gallons per day (gpd) or less from year-round and seasonal dwellings. The New York State Department of Environmental Conservation (NYSDEC) has published standards under 6 NYCRR Part 750, entitled, “Design Standards for Wastewater Treatment Systems for Intermediate-Sized Facilities” that apply to residential wastewater flows of over 1,000 gpd and other private, commercial and institutional systems. Each agency’s standards have similar OWTS design concepts and options for residential OWTSs; however, for residential systems discharging over 1,000 gpd, NYSDEC’s design standards and applicable permits apply.

In accordance with the New York State Education Law, plans for a design professional (professional engineer or registered architect) must prepare residential OWTSs licensed to practice in New York State by the State Education Department (SED). To provide an explanation and guidance to regulatory officials and interested parties regarding the need for a design professional to perform site evaluations and design residential OWTSs, NYSDOH with assistance from SED, developed a Fact Sheet titled “Need for Licensed Design Professionals – Residential OWTSs”. A copy of the Fact Sheet is provided in **Appendix B**.

New construction should routinely meet the standards established in Appendix 75-A; however, Section 75.3(d) of Part 75 and Section 75-A.11 of Appendix 75-A provide the option for the jurisdictional health department to issue a specific waiver for an individual situation because a hardship or other circumstance makes it impractical to comply with a design standard(s) specified in Appendix 75-A. Although specific waivers are not required for correction or replacement of existing failing residential OWTSs, local health departments (LHDs) may elect to issue specific waivers for such systems. Specific Waivers are discussed in Section 9.7 of this handbook.

A specific waiver is not required where a general or local waiver has been issued to a county health department or local government to address the design standard deviation. Multiple general waivers regarding various requirements also have historically been issued to LHDs and the New York City Department of Environmental Protection (NYCDEP) to address unique local area needs and conditions. General waivers presently in effect are summarized in **Table 10**.

Many of the design features and construction techniques included in this handbook represent recent improvements and advancements in wastewater treatment technologies, products and engineering applications as a result of intensive nationwide research in this field. Information presented in this handbook reflects the practices and experience of NYSDOH, LHDs, and industry professionals, national

wastewater treatment organizations, academia, other State agencies and recommendations of the United States Environmental Protection Agency (USEPA).

NYSDOH recognizes that some design concepts, products and technologies are not addressed in this handbook and that technological advances and new product developments will continue into the future. The use of new products and engineering techniques that have been shown to be effective but are not addressed in the standards may be considered on a case-by-case basis through the issuance of a Specific Waiver or on a limited and monitored demonstration basis for new products or new engineering applications as a means to accumulate operational experience data. Agreement for such installations shall be obtained from the LHD having jurisdiction prior to construction. The compilation of operational experience data can assist in the progressive evolution of systems deemed suitable for use in New York State.

This document is not a regulation; however, it is intended to provide valuable guidance and present proven practices for effective design, construction and maintenance of residential OWTs. With that intention, the terms “shall” and “must” are intended to indicate a requirement as stipulated in Appendix 75-A. The terms “should,” “recommended” and “preferred” are intended to indicate a recommendation, not a requirement.

1.1 Regulation by Other Agencies and Local Authorities

Sections 347 and 308 of the New York State Public Health Law give county, part-county and local boards of health authority to enact ordinances and regulations for protection of public health. Many communities have consequently enacted additional ordinances and regulations, which must be satisfied before residential OWTs, are installed. LHDs, municipalities, Watershed Protection Agencies (WPA), Responsible Management Entities (RME) and other agencies such as the New York City Department of Environmental Protection (NYCDEP) and the Adirondack Park Agency (APA), may establish more stringent standards from those specified in Appendix 75-A. In this Handbook, reference to “other local authority having jurisdiction” will include all of the above. Persons designing and/or contemplating construction of an OWT should consult with local authorities to ensure compliance with all existing additional requirements. Watershed rules and regulations must also be met where applicable. Local authorities to be contacted include local municipal Code Enforcement Officers, watershed inspectors, County Health Department staff and State Health Department District Office staff.

http://www.health.ny.gov/environmental/water/drinking/doh_pub_contacts_map.htm

Examples of regulations more stringent than Appendix 75-A are: higher daily design flow rate per bedroom, increased horizontal separation distances or increased vertical separation between the bottoms of absorption trenches to boundary conditions. If a site meets Appendix 75-A criteria for residential OWT design and construction and a more stringent standard exists, the design must be modified to incorporate the applicable more stringent standard(s) and is subject to local authority’s policies and procedures.

1.2 Acknowledgement

This “Residential Onsite Wastewater Treatment Systems Design Handbook” update was prepared by the Department’s Residential Sanitation and Recreational Engineering Section of the Bureau of Water Supply Protection, Division of Environmental Health Protection. Valuable assistance and insight was provided by the OWTs Advisory Committee, NYCDEP, NYS Conference of Environmental Health Directors, Local Health Department staff, NYSDOH District and Regional Office staff and the cooperation of many industry professionals and product manufacturers, all of whose contributions are gratefully acknowledged.

1.3 Introduction

Wherever practical, public sewer systems (such as municipal wastewater treatment plants and collection systems) are recommended for the collection and treatment of household wastewater. Residential OWTSSs shall only be used where it has been demonstrated that public sewer facilities are not feasible or available and where site conditions are suitable to support OWTSSs. Public sewer systems to collect and treat wastewater are preferred; however, the trend away from building new or expanding existing wastewater treatment plants, combined with development further from existing wastewater treatment plants will increase the reliance on OWTSSs as a long-term method of wastewater treatment for many New York State residents. New York State residents and visitors to New York also frequent summer camps, restaurants, motels, mobile home parks, recreation and tourist facilities that rely on OWTSSs.

Properly designed, constructed and maintained residential OWTSSs provide for a safe, sanitary means of treating and dispersing wastewater. Many gastrointestinal illnesses can be transmitted by water, food, insects, pets, and toys contaminated by human waste. Properly designed, constructed, and maintained OWTSSs minimize the possibility of disease transmission and help meet the goals of:

- (1) Not contaminating drinking water supplies, groundwater or surface water bodies.
- (2) Not creating a health hazard as a result of untreated wastewater exposed on the ground surface accessible to people or pets.
- (3) Not polluting the waters of any shellfish breeding ground, bathing beach or other recreational area.
- (4) Not creating a breeding place for insects, rodents or other possible disease carriers, which may come into contact with food or drinking water.
- (5) Not violating Federal, State and local rules and regulations governing water pollution or wastewater discharge.
- (6) Avoiding a nuisance condition resulting in obnoxious odors or unsightliness.

For OWTSSs located in sensitive areas or on difficult sites that need repair or replacement, the LHD should be contacted to obtain additional information, technical assistance, references, literature and research available regarding wastewater treatment technologies and methods. Specialized or critical situations may occur when soil is unsuitable, high ground water, rock or clay is too close to the ground surface, or concern exists over possible water supply (well or spring) contamination, stream impacts or lake eutrophication. In such cases, experienced professional consultation and special designs may be necessary. In some cases site and soil conditions preclude the use of OWTSSs and centralized sewers will be required for site development.

Henry Ryon, an engineer with the New York State Department of Health in the 1920's, conducted extensive research and was very instrumental in the advancement of OWTS design and policy. Previous to Ryon's studies, OWTS designs were rudimentary and based on simple site and soil evaluations. With the spread of suburbia after World War I and the increased use of domestic water due to expansion of public water service, or growth in residential water well use because of the rapid extension of electrical service to rural areas (which enabled the widespread utilization of well pumps and pressurized home plumbing), the subsequent routine installation of wet plumbing significantly increased the quantities of residential wastewater generated. Installation of public sewers did not keep pace with this increase of wastewater (as much as several hundred gallons per day per home). Consequently, proper onsite treatment and dispersal of domestic wastewater became necessary; however, the rudimentary OWTS could not properly manage this wastewater especially in densely populated areas. Improperly treated wastewater discharges from these OWTS at the surface and subsurface were common with corresponding increases in public nuisance problems and frequent pollution of water wells and surface waters.

To address these problems Ryon was charged with investigating the causes of failure of these rudimentary OWTS in the New York City suburbs. This included designing a temporary solution to provide for residential wastewater treatment and dispersal until public sewers were available. Ryon also recognized that many rural areas of New York State would probably never be served by public sewers (which is still true today). From this research, he developed the percolation test, an easy and simple but effective indicator of the ability of soil to absorb treated wastewater. Subsequent to the percolation test, and more significantly, Ryon developed a sizing formula for soil absorption systems. The sizing formula was based on the correlation of percolation test results with the ability of soils to accept cesspool (later septic tank) effluent. This method was quickly adopted throughout much of the rest of the United States and in many parts of the world.

This text is for historical interest only. Do not use for plan or design preparation.

Chapter 2

Construction Safety

Site investigation, soil evaluation and the installation of OWTs requires excavation, trenching, the use of heavy excavation equipment that presents many physical hazards and possible deep trench entry. Safety precautions for all onsite personnel are important. Excavations for test pits, seepage pits and septic tanks may create safety hazards. Experience warns us that depth as shallow as five (5) feet below ground level have caused injury and loss of life. It is the contractor's responsibility to assure that working conditions on the work site are not hazardous to workers or the public.

It is the law in the State of New York that "Dig Safely New York" and the New York City and Long Island "One-Call Center" be contacted to determine the location of any underground utilities in the area and thereby avoid potential excavation of hazards, unexpected downtime, loss of revenue, injury and disruption of utility service. The New York City and Long Island One-Call center provides service for all the five boroughs of New York City as well as Nassau and Suffolk Counties on Long Island. Dig Safely New York provides service for the rest of the state.

www.digsafelynewyork.com

Dig Safely New York: 811 or 1-800-962-7962
New York City and Long Island - One-Call Center: 811 or 1-800-272-4480

2.1 General Trenching and Excavation Safety Guidance

Trenches five (5) feet deep or greater can be very dangerous. All safety measures below should be followed:

- Protect yourself and others. Do not enter and do not allow entrance into an unsafe excavation!
- Provide safe access and egress to all excavations, such as ladders, steps or ramps.
- Keep heavy equipment away from trench edges.
- Keep soil spoils at least two (2) feet from trench edges.
- Benching of trench sidewalls can be used to mitigate caving potential.
- Avoid excavations during or shortly following a rainstorm.
- Be aware of heavy equipment and make sure the operator knows where you are.
- Excavations should not be left open and unattended. Safely backfill or barricade the excavation area(s).

Federal OSHA Construction Standards are applicable to excavations and trenches. Visit OSHA's Safety and Health Topics web page on trenching and excavation at:

<http://www.osha.gov/SLTC/trenchingexcavation/index.html>

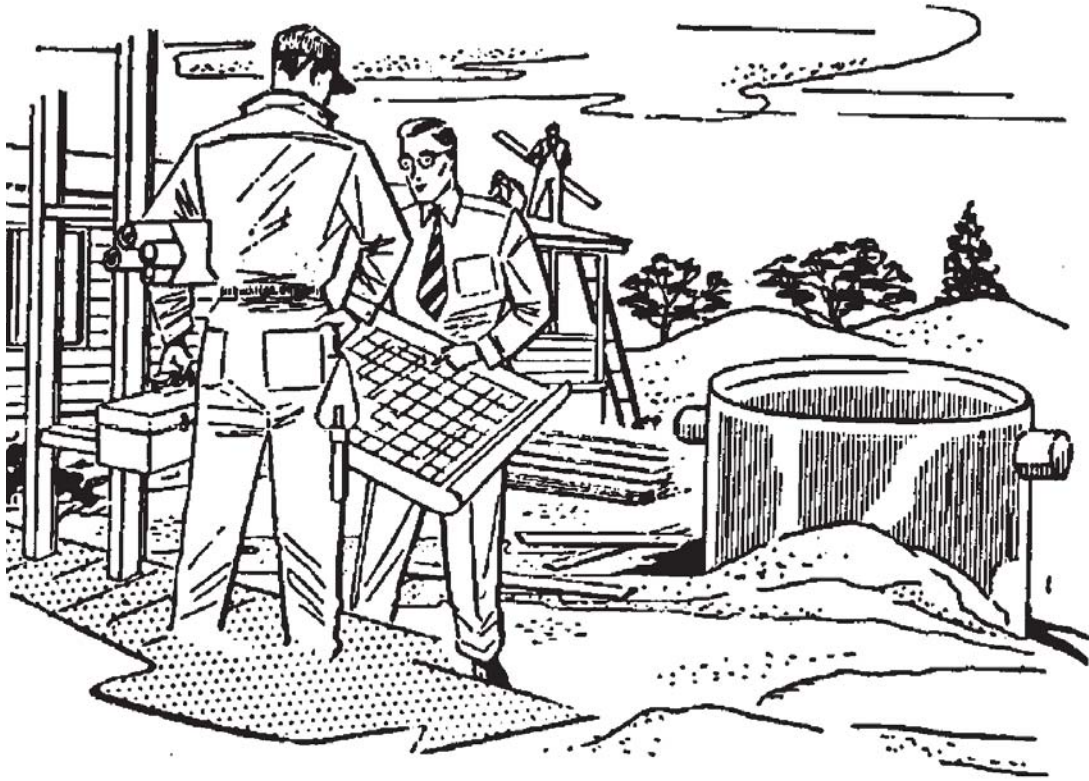

Above all, to properly maintain a disposal field and to assure its longer life, clean the septic tank when necessary. It is better to pump the tank too often than not often enough.

The cost of a disposal field is usually 10 times greater than the cost of cleaning the septic tank. Sometimes it is impossible to abandon a clogged field and replace it because of lack of lot space. Waste brines from household water softener units may cause a slight shortening of life of a disposal field installed in structured clay-type soil.

It is good practice to show the location of the various units of the disposal system on a sketch and reference them to permanent land marks. This is best done when the system is under construction and will prove useful in the future when earth covered units have to be located for maintenance purposes.

“Sewage Disposal Systems for the Home”

Part III, Bulletin No. 1

c. 1960s

This diagram and text is for historical interest only. Do not use for plan or design preparation.

Chapter 3

Wastewater Flows

The quantity and quality of daily wastewater flow that an OWTS may be required to accept, treat and distribute, is a major consideration in the design of the system. Toilet, bathroom showers and sinks, kitchen sinks and dishwashers, laundry and possibly drinking water supply treatment equipment discharges routinely contribute to this flow. Roof, footing, garage, cellar, and surface water drainage must be excluded from household plumbing and discharged away from the system.

Considerable variability in wastewater flow rate occurs from household to household. Many factors can influence the quantity and quality of daily wastewater discharges such as:

- Number of occupants (including homes used for vacation rentals and entertaining)
- Number of bedrooms
- Garbage grinders (increases solids and grease discharges)
- Type of water supply (public vs. private well)
- Water pressure
- Automatic dish washers
- Automatic clothes washers
- Spas and whirlpool baths
- Plumbing fixture types
- Individual user habits
- Leaking faucets and toilets
- Prevailing temperature
- High flow fixtures or features (multi-head showers, whirlpool tubs, etc.)
- Low flow fixtures and toilets
- High efficiency appliances
- Home business or hobbies (hairdresser, catering, painting, etc.)

Expansion attics, basements, sleeping porches, dens, and recreation rooms, which may be converted to additional permanent bedrooms in the future, should be considered in calculating daily design flow.

Minimum daily design flows for residential systems that are based upon the number of bedrooms in the dwelling and the age of fixtures are listed in **Table 1**. Design for new construction shall be based upon a minimum daily flow of 110 gallons per day per bedroom. Other daily design flows including those listed in **Table 1**, may be applicable for systems receiving wastewater from dwellings equipped with older plumbing fixtures, extreme water use fixtures (such as a multi-head shower system) or non-discharging toilets (such as a composter). Daily design flow rates for wastewater treatment system expansion to meet an actual or potential occupancy increase (for example adding rooms to a residence that will or can be used as bedrooms) should also be in accordance with **Table 1**.

It may be beneficial for the Design Professional to perform a homeowner interview and review architectural plans to account for potential bedrooms, occupancy, extreme water use fixtures, and intended uses that could affect wastewater discharges from the dwelling.

3.1 Water Softener Discharges

Water softening or other water conditioning equipment discharges are often directed to the OWTS through the household plumbing. In the majority of these cases, no problems are indicated with the OWTS. There have been some reports of issues, however, related to the discharge of water softener waste brine to septic tanks and specific soil types. Waste brine from household water softener units may have an adverse effect on the operation of a septic tank when the water treatment system is not operating properly and may cause a shortening of the life of an absorption facility, particularly when the system is installed in a structured clay type soil. Therefore, when possible, brine backwash waste from household water softening equipment should be discharged to a separate soil absorption facility such as a trench or shallow pit. Discharging brine backwash waste from household water softening equipment directly into the groundwater or on the surface of the ground is unacceptable. Care must also be taken not to dispose of concentrated backwash discharges containing dissolved sodium and chloride in areas or ways that can impact water supply wells. Separation distances required for conventional absorption facilities shall also be met for the backwash waste absorption facility. When softener discharges must be to the septic tank, the water treatment system should be maintained on a regular basis to ensure that the system is functioning properly. A water softener should be set to reflect the actual hardness, manganese or iron level(s) in the dwelling's water supply. An "as-needed" regeneration softener is recommended over an automatic timer-operated softener to minimize the number of regeneration brine discharges.

3.2 Low Flow Fixtures

Prior to 1980 toilets routinely used five (5) gallons per flush (gpf) and faucets and showerheads allowed three (3) to five (5) gallons per minute (gpm). This resulted in residential OWTS designs being based upon a daily design flow of 150 gallons per day per bedroom (gpdpb). This assumed two (2) people per bedroom [75 gallons per day per person (gpdpp)].

In 1980, the New York State Environmental Conservation Law (ECL) required that all sink faucets, lavatory faucets, showerheads, urinals, and toilets manufactured after January 1, 1980 comply with specific water saving performance standards. As a result, toilets manufactured between 1980 and 1991 were required to use no more than 3.5 gpf and faucets and showerheads limited flow to three (3) gpm. OWTSs serving dwellings constructed with 1980-1991 reduced flow-plumbing fixtures were designed based upon a daily design flow of 130 gpdpb (i.e., 65 gpdpp).

In 1992, the USEPA's "Energy Policy Act" required that the manufacture and sale of new water saving fixtures be implemented by 1994. At the time, available data predicted an approximate 15% decrease in water use with the installation of these water saving fixtures. This water saving prediction was applied to develop a daily design flow for OWTSs of 110gpdpb (55 gpdpp). EPA's current water use data confirm this is appropriate for most residences and other states use a similar range of daily design flow rates of 90-120gpdpb. Therefore, for new construction, residential OWTS designs are based upon a design flow of 110 gpdpb.

In 2006, USEPA launched the "Water Sense" program. This USEPA-sponsored partnership program promotes water efficiency and enhancing the market for water efficient products, programs and practices. Products such as shower heads, faucets, clothes washers and toilets (low flow and dual-flush) carrying the Water Sense label are certified to perform well and use less water include faucets: 1.5 gpm, showerheads: 2.0 gpm, toilets: 1.28 gpf, and clothes washers: at least 50% less water per load. For more information and a list of Water Sense products see: <http://www.epa.gov/WaterSense/>

Use of low flow fixtures can help reduce wastewater discharge volumes to the system; however, the biological load to the system will be about the same. Therefore, septic tank size and other certain

system parameters are not affected when water saving fixtures are used. New construction shall be designed based upon 110 gpd per bedroom; however, water saving fixtures such as Water Sense products can be very important when there is a need or desire to conserve water use and very helpful for low yielding wells and/or addressing existing OWTSS with limited soil absorption area available.

3.3 Spas, Whirlpool Baths, Hot Tubs and High Water Use Products

Spas and whirlpool baths are sometimes installed in residences served by OWTSS. Rapid draining of these units, which may contain a few hundred gallons of water, can interfere with the proper operation of a septic tank by disturbing settled solids within the tank. Draining should be controlled via the drain pump/valve to allow no more than five (5) gpm to discharge to minimize flow velocity into the septic tank. Spas, whirlpool baths and multi-head shower systems are typically connected to the household plumbing so frequent use could also affect the hydraulic load to the OWTSS. Overuse can result in premature failure of the absorption system due hydraulic overload or carryover of suspended solids from the septic tank. Multi-person hot tubs equipped with a recirculation and disinfection should never be connected to household plumbing or discharged to an OWTSS. Hot tub discharges should be managed similar to swimming pool backwash and draining.

3.4 Protecting the Onsite Wastewater Treatment System

All toilet, bathroom, kitchen, and laundry wastes from a household shall be discharged into the septic tank. Household chemicals such as bleach, disinfectants, cleansers, antibacterial soaps, etc., when used in normal household applications, should not disrupt septic tank or absorption system operation. Roof, footing, garage, cellar, surface and cooling water must be excluded from septic tanks and discharged away from the absorption area.

Materials not readily degraded such as paper towels, newspaper, wrapping paper, rags, cotton swabs, sanitary napkins, feminine hygiene products, condoms, disposable diapers, coffee grounds, cat litter, cooking fats/oils, bones, facial tissues, dental floss and cigarette butts should not be flushed into septic tanks. These products do not degrade in the tank and can clog inlets, outlets, and the absorption system. Other often-used household products that should not be discharged into septic tanks include antifreeze, pesticides, herbicides, oil, gasoline, paint, turpentine or other hazardous chemicals.

Unused pharmaceuticals and personal care products (fragrances, cosmetics, sunscreens, etc.) should not be flushed down the toilet or washed down the drain. Check with local officials or pharmacies to see if household drug collection is available or if other disposal options exist. If not, alter the medications in some way to make them unpalatable and place them in the trash. For more information on proper disposal of pharmaceuticals, see: <http://www.dec.ny.gov/chemical/67720.html>

To avoid overloading the system, homeowners should use water efficiently, repair leaky faucets or toilets, install low-flow fixtures, purchase high-efficiency appliances and avoid using a garbage disposal unit. See **Appendix F**, “Septic Systems - Operation and Maintenance”.

	Gal. per cap. per day.		
	low	high	av.
Municipalities	50	150	100
Toilets	10	15	15
Lavatories	5	10	10
Tubs & Showers	5	15	15
Culinary	10	15	15
Laundry	10	15	10
Industrial & Seepage	10	80	35
Institutions (24hr.)	50	125	75
Toilets			15
Lavatories			10
Showers (15), Tubs (10)			15
Culinary			15
Laundry			10
Schools (day) & factories	9	50	15
Toilets	6	15	10
Lavatories	3	10	5
Showers	0	15	0
Culinary	0	10	0
Country Clubs	20	50	35
Toilets			5
Lavatories			5
Showers (users)			5
Culinary			5
Laundry			5
Hospitals	100	300	200

H RYON

Quantity of Sewage.

NOTES
ON
SANITARY
ENGINEERING

HYDRAULICS
SEWERAGE
SEWAGE DISPOSAL
WATER SUPPLY

HENRY RYON

1924

This table and text is for historical interest only. Do not use for plan or design preparation.

Chapter 4

Soil and Site Appraisal

4.1 Purpose

A comprehensive soil and site investigation will identify the preferred location for an OWTS and the type of system that is appropriate for the site conditions. In some cases site and soil conditions preclude the use of OWTSs and centralized sewers will be required for site development.

The cost of an OWTS is heavily influenced by prevailing soil and site conditions. If a home must be located on marginal soils or if enhanced treatment of wastewater is necessary, considerable expense will be incurred to construct an OWTS. Sites exhibiting site conditions such as rock outcroppings, high ground water, poor soils (very slow or very fast percolating), limited available space, poor drainage or excessive slopes may require specialized engineering and technology at a considerable expense to design and install an OWTS. Slower soil percolation rates require larger subsurface absorption areas.

Poorly drained sites may require special surface and/or subsurface drainage to prevent periodic failures caused by rising ground water levels or ponding of surface drainage from snowmelt or rainstorms. The solution and control of such problems require consideration of the total drainage area. The State or local highway agency may be helpful in providing an overview of drainage provisions.

4.2 Site Investigation

Selection of the OWTS location must be an integral part of the initial home site layout and not a simple accommodation. Construction of the home or drilled well should not begin until the OWTS has been properly located and designed. Therefore, a field evaluation of the site and soil characteristics should be conducted before purchase or development of the property. Low areas likely to be flooded every ten (10) years or more frequently, (10-year flood plains) shall be avoided. Areas likely to be flooded every 100 years or more frequently (100 year flood plains) should also be avoided or special precautions and construction should be considered. Flood plain maps are available at most city, town or village building departments or can be researched on the “floodsmart” website:

<http://www.floodsmart.gov/floodsmart/>

4.3 Separation Requirements

Separation distances between OWTS components and property boundaries, structures (existing or planned) and other site features are required to maintain OWTS performance, permit service, allow for repairs and minimize undesirable effects of underground wastewater dispersion. These include property lines, rights-of-way, easements, water supplies, wetlands, watercourses, buildings and utilities. Wetland or watercourse determinations should be addressed with the LHD or other local authority having jurisdiction and the applicable NYSDEC regional office. Required horizontal separation distances from OWTS components are shown in **Figures 1 and 2** and listed in **Table 2**. Horizontal separation distances from water supplies (such as drilled wells), including OWTS components, are

established in NYSDOH Appendix 5-B, “Standards for Water Wells” and Appendix 5-D, “Special Requirements for Wells Serving Public Water Systems”.

Rock outcroppings serve as a warning that shallow soils are present and suggest the probable direction of near surface drainage flow. The site investigation should indicate the depth of useable permeable soil at the site above rock, presence of unsuitable soil and high seasonal ground water.

The effluent from an OWTS contains pathogenic bacteria, viruses, dissolved nutrients and potentially some chemical contaminants that are capable of traveling distances if they reach the ground water aquifer, especially in creviced and channeled rock. To minimize the possible health hazard and pollution potential of treatment system effluent, absorption areas should be located well above the seasonal high ground water level (at least two (2) feet in most cases) and as far as possible from drinking water supplies and surface waters. The minimum required vertical separation distances and other site requirements for OWTS options are listed in **Table 4**. The combined horizontal and vertical separation distances for each OWTS are called “boundary conditions”.

The required infiltrative area is determined from: (a) properly conducted soil percolation and deep hole tests to accurately identify the site and soil conditions and (b) projected wastewater dispersion direction. For design and planning purposes, an additional useable area of 50% of the absorption area should be reserved for future expansion or repair of the absorption area. Whenever possible, it is recommended that an area equal to 100% of the required absorption area be reserved to facilitate full absorption system replacement. Insufficient useable land to provide for an expansion or reserve area should not necessarily preclude acceptance of OWTS designs. Technology and other mitigation measures are available to provide viable alternatives to reserving land for future possibility of system expansion or repair. Note, however, that reserving an area sufficient for full absorption field replacement or at least enough area to support system expansion can be cost effective in the long term because complete absorption field relocation or applying a remedial technology can be expensive. A properly designed, constructed, and maintained OWTS has an average expected useful life of 20 to 25 years and can often be much longer.

Local sanitary codes, zoning ordinances or WPAs may control the inspection, design and installation of systems. Many LHDs or other local authorities having jurisdiction will require their staff to be present during the site evaluation (including percolation tests and test pits), require that plans be submitted and approved before construction starts, perform inspections of the system installation prior to backfilling/covering and/or require certification from the design professional that the OWTS installed was in conformance with approved plans prior to household occupancy. Due to the many regulations and local procedures that may be in effect, the LHD having jurisdiction should be consulted prior to performing the site evaluation, design and construction of a household OWTS.

When a LHD or other local authorities having jurisdiction does not implement a residential OWTS program, the local Code Enforcement Officer (CEO) for the New York State Fire Prevention and Building Code should utilize the New York State Residential Code’s generally accepted standards to ensure compliance with Appendix 75-A standards.

4.4 Selecting Drinking Water Well Location

The type, number and separation distance to OWTSs or other sources of pollution in the vicinity of a well indicate the potential for nearby contamination of the ground water supplying the well. Ground slope and rock outcrops indicate the probable direction of surficial drainage and possible ground water flow direction. This should be considered when evaluating the location for a well to minimize potential pollution. Well construction, depth to the aquifer, soil type above the aquifer, volume/rate of

water pumped and well drawdown are also extremely important since they affect the distance and travel time of polluted waters. Usually, potential pollution of wells is minimized by increased distance and travel time.

When pumping from a well, localized ground water flow will tend to be toward the well. Since the pumping level of water in the well may frequently be 50 to 150 feet or more below the ground surface, well pumping may exert an attractive influence on ground water as far as 500 to 1,000 feet away from the well, regardless of the elevation to the top of the well. Therefore, distances to and elevations of OWTS must be considered relative to the elevation of the water level in the well while it is being pumped. An OWTS located 100 feet away on level ground or down grade from a well may still be 50 feet above the pumping water level in the well.

Required separation distances are sometimes impossible to meet for the repair or replacement of a failing or existing substandard OWTS. Information on the well such as well depth, casing depth, well grouting depth, well water quality, depth to the aquifer and subsurface geology/hydrogeology should be carefully evaluated when considering any reduction in separation distances. Example: the existence of an impervious soil stratum between the OWTS and a ground water aquifer used as a drinking water source provides additional protection of the aquifer.

Considerable judgment is needed to select a suitable location for a well. The separation distances listed in **Table 2** of this handbook and Table 1 of Appendix 5-B, “Standards for Water Wells”, should be used as a guide for locating residential wells. Experience has shown that these distances are reasonable and effective in most instances when coupled with proper interpretation of available hydrologic/geologic data and satisfactory well construction.

Appendix 5-B, Appendix 5-D (“Special Requirements for Wells Serving Public Water Systems”), NYSDOH Individual Water Supply Wells Fact Sheets #1 through #5, NYSDOH Fact Sheet “Concerns About Surface Water as a Drinking Water Source”, Part 75 and Appendix 75-C (“Individual Water Supply System Testing”), contain additional information regarding well water supplies. The Fact Sheets are included in **Appendix B** of this handbook. Drilled wells should be developed and tested for quality and quantity prior to commencement of home construction.

Specific Waivers are needed for reductions in boundary conditions for new OWTS construction or when installing a new or replacement drilled well. Specific Waivers are discussed in Section 9.7 of this Handbook.

4.5 Soil Investigation

Soils vary widely in character. Most soils are mixtures of stones, sand, silt, clay, and organic matter. Soils usually contain microorganisms capable of breaking down organic matter and microorganisms capable of assisting in soil aeration. Soil survey maps and reports have been developed for most counties in New York State and are available from the United States Department of Agriculture (USDA). While helpful in determining general soil and soil-moisture characteristics and suitability for various uses, the maps/reports are not substitutes for an on-site soil investigation. The USDA soil maps can be accessed at <http://websoilsurvey.nrcs.usda.gov/app/HomePage.htm>

The nature of the stratum immediately under the upper soil layer can affect the treatment and transport of wastewater. Dense substrata, such as clay, fragipan, shale, argillite, and cemented limestone restrict the limits of vertical movement of wastewater. Highly fractured or channeled rock substrata underlying shallow soil profiles may facilitate such rapid water movement that contamination of ground water, and nearby streams/lakes could occur. Deep test holes or borings are used to determine: (1) the presence/absence of such underlying substrata, (2) seasonal high ground water levels, (3) depth to

bedrock, (4) types of soils penetrated, and (5) other features such as root systems, land drains, etc., which may affect the design and operation of a OWTS.

Accurate identification of seasonal high groundwater is critical for OWTSs to function properly year round. Absorption areas must remain unsaturated and allow the exchange of oxygen into the soil. Determination of seasonal high ground water levels are performed by evaluating the soils using a deep hole test. Soil evaluations consist of observing soil types, layers and mottling (soil color patterns). Soil scientists, geologists, design professionals or other properly trained persons should perform soil evaluations. Information regarding soil mottling needs to be obtained from all deep hole tests to ensure proper OWTS design and function.

Gray soil colorations are associated with saturated and chemically reducing conditions of minerals in soil (iron and manganese) and yellowish-brown colorations are associated with aerobic and chemically oxidizing conditions of those minerals. Soils with high water tables during some parts of the year generally exhibit variable mottling at the depth of the high water mark and below. Soil mottling colorations may be difficult to observe during summer months in some soils due to the inherent color properties of the soil.

High ground water levels (free water surface in a deep hole test) are usually at its highest during the normal spring high ground water period (March 15 to June 30); however, winter or spring drought conditions may lower the usual ground water level. Therefore, the presence of soil mottling must always be checked. In some soils, high ground water can only be accurately determined by monitoring a free water surface in an excavated hole or shallow monitoring well during the spring high ground water period because mottling will not be evident.

Site vegetation can also offer clues regarding surface and ground water levels. Recognizing the types of plants that grow on wet soils (e.g., certain ferns, cattails, purple loosestrife), can help verify the findings of deep hole tests.

The depth of a deep hole test is determined by the type of absorption system to be installed. If a shallow subsurface system such as a conventional absorption trench or absorption bed system is proposed, at least four (4) feet of useable soil shall be available above impermeable strata or the high ground water level. The four (4) foot depth determination provides a minimum separation of two (2) feet beneath the bottom of an absorption trench/bed. Deep hole tests for proposed absorption fields should be at least six (6) feet deep (preferably four (4) feet deeper than the bottom of proposed absorption trenches/bed) to facilitate observation of soil mottling/discoloration on the sidewalls of the hole and other boundary conditions. At least one (1) deep hole test shall be dug within or immediately adjacent to the proposed absorption area to assure that uniform soil and site conditions prevail.

If observations of deep hole tests, percolation test holes, excavations, grading cuts, etc. reveal widely varying soil profiles, additional deep hole tests shall be dug and observed to assure that a sufficient area of useable soil is present for the installation of the proposed absorption facility. At least one (1) deep hole test may also be required to be dug within or immediately adjacent to the proposed absorption expansion area to assure that uniform soil and site conditions prevail. OWTSs shall be designed to reflect the most severe conditions observed within the proposed absorption area. Note that judgment should be utilized not to excavate too many test pits within the proposed treatment area to avoid changing natural soil characteristics.

Where absorption systems are to be installed above drinking water aquifers, the local health department or other local authority having jurisdiction may require a greater vertical separation distance to bedrock (limestone, karst, shale, etc.) Absorption systems should not be constructed directly over visible cracks, crevices, sinkholes, or other formations that may facilitate rapid dispersion into groundwater.

Seasonal weather variations markedly affect ground water levels. Heavy spring rains combined with annual snow melt in New York State normally raise groundwater to its high level between March 15 and June 30. Cycles of drought and flooding obviously influence the “high ground water level” reached during any particular year. Hence, information regarding soil mottling/discoloration should be obtained from all deep hole tests, whenever available; to supplement any observed high ground water levels. Periodic observations of shallow monitoring wells throughout the normal spring high ground water period produces an accurate determination of the high water table at a given site for a given year.

4.5.1 Soil Investigation for Seepage Pits

Seepage pits provide less treatment than absorption trenches/beds because of the limited air exchange necessary for biological treatment. If soil and site conditions are adequate for absorption trenches seepage pits shall not be used.

Three (3) feet of useable soil must exist beneath the bottom of seepage pits (i.e., above ground water, bedrock or impervious strata). Deep hole tests for proposed seepage pits shall be at least five (5) feet deeper than the bottom of the proposed seepage pits to facilitate observation of soil mottling/discoloration on the sidewalls of the hole and other boundary conditions. At least one (1) deep hole test shall be dug at, or immediately adjacent to, the proposed location of seepage pits to assure that uniform soil and site conditions prevail. If observations of deep hole tests, percolation holes, excavations, grading cuts, etc. reveal widely varying soil profiles additional deep hole tests shall be dug and observed to assure that a sufficient area of useable soil is present for the installation of the proposed seepage pits. The effective seepage pit sidewall absorption area calculation includes only soils with a percolation rate of one (1) to sixty (60) minutes per inch. No allowance for seepage pit infiltration area is made for the bottom area of a pit. Any bottom area or sidewall soil with a percolation rate faster than one (1) minute per inch precludes use of the site unless soil blending produces at least three (3) feet of filtration through blended soil with a percolation rate of one (1) to sixty (60) minutes per inch.

Note that parts of Long Island do use seepage pits due the nature of construction, soil conditions and known hydrogeology. General Waivers were issued to Suffolk and Nassau Counties allowing the use of seepage pits in their jurisdiction. **Table 10** lists General Waivers in effect.

4.6 Soil Identification

Another item used in subsoil investigation is soil texture. This refers to the proportion of sand, silt and clay. Soil textural classifications noted by the USDA’s Natural Resources Conservation Service (NRCS) are depicted in **Table 12**. In the field, the percentages of sand, silt, and clay particles in a soil can be estimated by feel by experienced soil scientists, geologists or design professionals. Detailed soil analysis should be determined by laboratory analysis. The following descriptions can be used in identifying soil texture.

Sand: Individual grains can be seen and felt readily. Squeezed in the hand when dry, this soil will fall apart when the pressure is released. Squeezed when moist, it will form a cast that will hold its shape when the pressure is released but will crumble when touched.

Sandy Loam: Consists largely of sand, but has enough silt and clay present to give it a small amount of stability. Individual sand grains can be seen and felt readily. Squeezed in the hand when dry, this soil will fall apart when the pressure is released. Squeezed when moist, it forms a cast that will not only hold its shape when pressure is released, but will withstand careful handling without breaking. The stability of the moist cast differentiates this soil from sand.

Loam: Consists of an even mixture of the different sizes of sand and of silt and clay. It is easily crumbled when dry and has a slightly gritty, yet smooth feel. It is slightly sticky and plastic. Squeezed in the hand when dry, it will form a cast that will withstand careful handling. The cast formed of moist soil can be handled freely without breaking.

Clay Loam: A fine textured soil, which breaks into clods or lumps that are hard when dry. When a ball of moist soil is pressed between the thumb and finger, it will form a thin ribbon that will break readily, barely sustaining its own weight. The moist soil is plastic and will form a cast that will withstand considerable handling.

Silt Loam: Consists of a moderate amount of fine grades of sand, a small amount of clay, and a large quantity of silt particles. Lumps in a dry, undisturbed state appear quite cloddy but they can be pulverized readily; the soil then feels soft and floury. When wet, silt loam runs together and puddles. Either dry or moist casts can be handled freely without breaking. When a ball of moist soil is pressed between thumb and finger, it will not press out into a smooth, unbroken ribbon but will have a broken appearance.

Clay: A fine-textured soil that breaks into very hard clods or lumps when dry, and is plastic and unusually sticky when wet. When a ball of moist soil is pressed between the thumb and finger, it will form a long ribbon.

Structure is also a characteristic used in soil investigation. A moist or dry soil mass in its natural state tends to break into pieces of a rather definite shape resembling a geometric figure or some other material. Thus, a soil may have a prismatic, block, granular, crumb or platy structure. Structure is indicative of drainage characteristics and is used to determine the limits of soil horizons. Soil structure should not be confused with the structural (strength) characteristics of a soil.

4.7 Soil Percolation

Infiltration and percolation govern the absorptive capacity of soil. Infiltration is the passage of liquid across the liquid-soil interface and percolation is the passage of liquid through soil once it has crossed the interface. Soils with high clay content may not allow adequate passage of liquid and therefore, are generally unsuitable for subsurface treatment. Usually the coarser the soil particles are the faster the soil percolation rate is. If groundwater levels are high, even soil of high permeability will not allow sufficient liquid to percolate.

The smearing or compaction of absorption trench or seepage pit sidewalls or bottoms during excavation and construction will severely restrict infiltration. Low capacity for either infiltration or percolation may cause a household OWTS to fail. A poorly operating septic tank system, which allows the passage of suspended solids and grease, may cause physical, chemical and/or biological clogging at the liquid-soil interface and restrict infiltration.

Percolation rates, projected daily design flow rates and observed horizontal and vertical boundary conditions are used to design absorption area location, type and size. A typical soil percolation test hole is depicted in **Figure 3**.

4.7.1 Soil Percolation Testing

Persons with training/experience in conducting such tests should conduct percolation tests. They include but are not limited to design professionals, surveyors, sanitarians, soil scientists, geologists, technicians, WPA inspectors and system installers. The design professional is responsible for the percolation test results used in their design of an OWTS.

Soil percolation test results are indicative of the ability of a soil to absorb and transmit wastewater treatment system effluent. If the percolation test results are inconsistent with field determined soil conditions then additional percolation tests must be conducted and the slowest percolation rate (most restrictive) observed shall be used to design the absorption facility. Percolation tests may be conducted anytime except when the ground is frozen, or when precipitation interferes with the test (adds water to the test hole).

In general, for most proposed absorption systems, at least two (2) percolation tests shall be performed within the proposed absorption area with the bottom of the test holes located at the proposed bottom of the absorption trench or bed. The slowest percolation test results shall be used to design the absorption facilities. At least one (1) percolation test should also be performed in the proposed reserve area.

Appendix D contains a copy of the NYSDOH Percolation Test Data sheet and percolation test instructions. **Table 4** shows the depth of percolation tests for each type of subsurface treatment system and corresponding required site conditions.

4.7.2 Soil Percolation Test Procedure

The procedure noted below should be followed in performing a soil percolation test:

- (1) Make sure proper construction safety practices are followed.
- (2) Dig a hole with vertical sides approximately 12 inches wide on all four (4) sides or 12 inches in diameter. The depth of the test holes should be 24 to 30 inches below final grade or at the projected bottom of trenches in shallower or deeper systems. Holes shall be hand dug; the use of a backhoe to excavate the upper soils is not acceptable. It is necessary to place washed aggregate in the lower two (2) inches of each percolation test hole or employ another method that will reduce scouring and silting action when water is poured into the hole. The sides of percolation holes should be scraped to avoid smearing.
- (3) Pre-soak the test hole by periodically filling the hole with water and allowing the water to seep away. This procedure should be performed for at least four (4) hours and should begin one (1) day before the test, except in clean, coarse sand and gravel. After the water from the final pre-soaking has seeped away, remove any loose soil that has fallen from the sides of the hole. Pre-soaking saturates the surrounding soil and allows for clay in the soil to swell, simulating when a system is in operation and receiving wastewater effluent.
- (4) Pour clean water into the hole, with as little splashing as possible, to a depth of six (6) inches above the bottom of the test hole.
- (5) Observe and record the time in minutes required for the water to drop from the six (6) inch depth to the five (5) inch depth.

- (6) Repeat the test a minimum of three (3) times until the time for the water to drop from six (6) inches to five (5) inches for two (2) successive tests is approximately equal (i.e., ≤ 1 minutes for 1 – 30 min./inch; ≤ 2 minutes for 31-60 min./inch). The longest time interval to drop one (1) inch shall be taken as the stabilized rate of percolation and shall serve as the basis of design for the absorption system. Note that except for sandy soils, properly pre-soaking a percolation test hole will typically shorten the time spent for successive percolation rates to become equal.

For example, assume the following times were recorded while performing steps (d), (e), and (f) above:

Run Number	Time for One Inch Drop (Minutes)
1	24
2	27
3	30
4	30

Based upon these results, the percolation rate to use for design purposes is 30 minutes per inch.

4.7.3 Seepage Pit Percolation Tests

If a seepage pit is used, percolation tests should be conducted at one-half the depth and again at the full estimated depth of the seepage pit. In order to facilitate conducting the test and preventing cave-in, a two-tiered excavation should be made approximately two (2) feet above the bottom of the proposed seepage pit and two (2) feet above the half-depth of the proposed seepage pit. Percolation test pits should be dug approximately two (2) feet deep into each tier base. At least two (2) percolation tests shall be performed with the bottom of the percolation tests holes at the proposed pit bottom depth and half of the proposed pit depth. If different soil layers are encountered at the proposed pit sidewall area, a percolation test shall be conducted in each permeable layer and the seepage pit design percolation rate shall comprise the weighted average of each test result based upon the depth of each permeable layer. No allowance for infiltration area is made for the bottom area of a pit or the pit sidewall area of impervious strata (i.e., percolation rate slower than 60 minutes per inch).

Chapter 5

House Sewer Drain

5.1 General Information

The house sewer drain, which collects the discharge from gray and black water plumbing in the house, extends outside the building (usually basement) wall and connects to the septic tank or public sewer line. The house sewer drain is designed to convey these household wastewater discharges to the septic tank or public sewer line at sufficient slope to achieve a flow velocity that will prevent settling of solids in the drain line. A household plumbing system is also designed to enable gases from the septic tank or public sewer line to be vented to the atmosphere through the house plumbing vent system (soil stack and/or vent stack). Plumbing for residences served by OWTSs shall be installed in a manner to avoid interference with the flow of gases and air from the absorption area, distribution box, and septic tank through the house-plumbing vent. Where local building code requires the use of a whole-house building trap on the sewer drain line, vent piping should be installed on the building drain from a point immediately downstream of the building trap to the vent stack to allow the septic tank gases to vent and facilitate aeration of the absorption field by negative pressure. A typical house plumbing and venting system is shown in **Figure 4**.

House sewer drains shall be made of sound and durable material, have water-tight construction, have a minimum diameter of four (4) inches and be laid on a firm foundation at a minimum grade of one-quarter ($\frac{1}{4}$) inch per foot. House sewer drains should be installed with as straight an alignment as possible. If bends are necessary, a maximum bend of 45 degrees shall be used and fitted with an appropriately installed clean out of the same size as the house sewer drainpipe. More than one cleanout may be required depending on the length of run. The clean out should be extended to the ground surface and properly capped/plugged for maintenance purposes. At least one (1) clean out with a properly fitted plug is required on the house drain within the building to provide access to the house sewer drain for maintenance.

House sewer drain construction, including materials, shall comply with applicable requirements of the State Uniform Fire Prevention and Building code, Residential Code, Chapter 30, Sanitary Drainage.

5.2 Separation Between Water Supply Lines and House Sewer Drains

A minimum horizontal separation of ten (10) feet shall exist between the house sewer drain and any water supply line. Where these lines must cross, the water supply line shall be installed to provide a minimum vertical separation of at least 18-inches between the outside of the water line and outside of the sewer drain line. This shall be the case where the water line is either above or below the sewer drain line with preference to the water line being located above the sewer drain line. Suction water lines shall never cross under house sewer drains or any other component of an OWTS.

When it is not possible to obtain proper horizontal and vertical separation as stipulated above, the following mitigative measures may be considered:

- (1) The house sewer drain shall be constructed of rigid pipe and shall be pressure tested to assure water tightness.
- (2) The water line or the house sewer drain, or both, may be encased in a watertight carrier pipe that extends ten (10) feet on both sides of the crossing when measured perpendicular to the water line.

The absorption area and designated reserve area should be located at least ten (10) feet from any water service line (public water supply main, public water service line or residential well water service line) to allow access to the water line without having to excavate in the absorption area. The water line should be constructed and located to minimize the exposure to OWTS dispersion or the impact to the function of the OWTS (such as the water line should not be located down gradient of the absorption area). In cases where it is not practical to maintain a ten (10) foot separation from the system or its components, mitigative measure(s) such as pipe encasement should be implemented.

Chapter 6

Septic Tanks

6.1 General Information

Wastewater collected from the house sewer drain must undergo treatment prior to discharge to a soil absorption area. Devices such as septic tanks or enhanced treatments units (ETUs) provide varying degrees of physical and biological treatment. Physical treatment is restricted to processes dependent upon the concentration of wastes in, and the quality of, wastewater. Septic tanks are settling chambers that reduce turbulence and velocity of household wastewater discharges and permit time for physical separation of most floating and settleable solids in the wastewater. Materials heavier than water settle to the bottom and form “sludge”. Materials lighter than water rise to the surface and form “scum”. It is important that scum and sludge does not escape the septic tank and overload or clog the absorption field. A typical septic tank is depicted in **Figure 5**.

Two groups of bacteria, aerobic and anaerobic, provide biological treatment of wastewater. Aerobic bacteria degrade organic matter in the presence of air or oxygen. Anaerobic bacteria perform a similar function in the absence of elemental oxygen but at a much slower rate.

Septic tanks are large watertight chambers that promote the growth of anaerobic bacteria for the biological decomposition of wastewater and provide detention time for sludge and scum to form. Septic tanks should be sized for a minimum detention time of 36 hours and constructed with a baffle or sanitary tee on the inlet and the outlet of the tank to assure retention of floating material and settleable solids. Performance of a septic tank can be improved by installing an effluent filter on the outlet and septic tank compartmentalization. Neither scum nor sludge should be scoured from the septic tank by wastewater flowing through the tank.

Rising gases routinely produced by anaerobic digestion of organic matter in septic tanks interfere with particle settling and cause re-suspension of previously settled solids (sludge). Therefore, at a minimum, the outlet baffle or sanitary tee should be equipped with a gas deflection device to minimize the flow of such particles/solids out the septic tank. Increasing the diameter of the vertical section of an outlet sanitary tee to more than four (4) inches is recommended to decrease up-flow velocity and potential discharge of suspended solids out of the septic tank. Use of an effluent filter also minimizes flow of particles/solids out of the septic tank.

Pumped out septic tanks contain toxic gases and shall not be entered by a homeowner. Only trained persons utilizing oxygen breathing apparatus and proper confined space protocols should attempt to enter or repair a pumped out septic tank. If a leak below the liquid level cannot be repaired or sealed, the tank must be replaced.

Although minimum capacities for septic tanks are established in **Table 3**, larger tanks have the advantages of providing longer detention times, requiring less frequent pump-outs and being able to accommodate changes to the home (such as adding bedrooms, spa tub or garbage grinder). Larger tanks typically provide a good cost-benefit return.

Table 3 specifies minimum septic tank capacities based upon the number of bedrooms. Expansion attics or other rooms that could reasonably be converted to a bedroom should be counted as

an additional bedroom for tank sizing purposes. A garbage grinder or whirlpool tub/spa should also be considered equivalent to an additional bedroom for determining tank size. Garbage grinders should be avoided; however, if a garbage grinder can reasonably be expected to be installed, an effluent filter or gas deflection baffle and a dual compartment tank or two tanks in series must be provided because of the increased solids and greases that will be discharged to the septic tank. An effluent filter or gas deflection baffle should also be provided whenever any full width outlet baffle exists in a septic tank to minimize solids carryover to the absorption area. **Figure 6** depicts typical septic tank enhancements for gas deflection and an effluent filter.

6.2 Effluent Filters

Effluent filters protect absorption areas from premature clogging and failure due to the release of non-settleable solids and/or non-degradable flushed materials from the septic tank. Effluent filters are installed on the outlet of the septic tank or the last septic tank in-series before distribution to the absorption area. Installation of septic tank effluent filters is an inexpensive method to enhance the effectiveness of a septic tank. Effluent filters may also protect homeowners from inadvertently causing extensive and expensive damage to their absorption area. When an effluent filter is installed there should also be a riser installed extended to the ground surface for access to the filter for maintenance. It is recommended to use filters that have been certified under NSF Standard 46. Effluent filters should be inspected about every six (6) months for signs of clogging; however, unless premature clogging of the filter is detected, filters should only need to be cleaned (washed off into the septic tank) when the septic tank is emptied of solids every 2 to 3 years by a NYSDEC permitted septage waste transporter (septic tank pumper). Slow drainage or plumbing backup may be an indication of filter clogging. Some effluent filters can also be equipped with an alarm to warn of clogging so maintenance can be performed before sewage backs up into the house.

6.3 Septic Tank Location

Septic tank openings (manhole covers) should always be accessible. Manholes or removable covers shall not be located more than 12 inches below final grade. It is recommended that septic tank openings be brought flush with or above the ground surface. If brought to grade, the manhole cover shall be lockable or incorporate another method to prevent easy entry or tampering, especially by children. The grade around the manhole cover should slope away to direct surface water away from the septic tank. Manhole extension collars can be used to bring the manhole to grade or within 12 inches of grade when septic tanks must be installed at greater depths. When septic tank access covers are not brought to the surface, the location of each manhole cover should be identified by installing a stake or marker at grade. Stakes or markers permit rapid location for inspection and maintenance with minimal landscape disturbance.

Driveways, parking lots and other areas that allow traffic shall not be constructed above septic tanks unless the tanks are specially designed and reinforced to safely carry the loads imposed and provide access to the tank for maintenance. Check with the septic tank manufacturer when excessive loads or burial depths are expected. Objects and structures, such as swimming pools, sheds or decks, shall not be constructed above septic tanks since they may interfere with tank operation and maintenance.

Minimum horizontal separation distances of septic tanks from wells, watercourses, building foundations, property lines, drainage ditches, and other site features must be maintained as indicated in **Figure 1** and **Figure 2** and listed in **Table 2**.

A sketch or plan of the as-built OWTS and components should be prepared by the design professional or installer and retained by the homeowner for future inspection and maintenance needs. The sketch or plan should indicate measured distances from system components (septic tank manholes, pump tank manholes, distribution box, corners of the absorption trenches or bed, etc.) to relatively permanent points such as corners of the house foundation, property stakes, street pavement/curbing or utility poles.

6.4 Septic Tank Design and Installation

The following general requirements apply to all septic tanks regardless of construction material:

- (1) The minimum liquid depth is 30 inches. The maximum depth for determining the allowable design volume of a tank shall be 60 inches. Deeper tanks provide extra sludge storage but no credit is given toward design volume.
- (2) The minimum distance between the inlet and outlet shall be six (6) feet. All tanks shall meet the minimum surface area requirement for the specific design volume in **Table 3**. The effective length of rectangular tanks should not be less than two (2) nor greater than four (4) times the effective width.
- (3) Tanks must be watertight, constructed of durable material, and not subject to excessive corrosion, decay, frost damage, or cracking. When installed, the top of all tanks shall be able to support at least 300 pounds per square foot (psf).
- (4) Tank access covers and manhole covers should be brought to the ground surface; however, at a minimum, they shall be within 12 inches of final grade to permit inspection and maintenance. Tanks shall have at least one (1) manhole opening and visual access openings above the inlet and outlet baffles. A manhole opening may replace a visual access opening. Tanks with a liquid depth of 48 inches or more shall have a top opening with a minimum of 20 inches in the shortest dimension to allow entry into the tank. Tanks with a liquid depth less than 48 inches shall have a top opening that is at least 12 inches in the shortest dimension. When the top of a septic tank is more than 12 inches below final grade, watertight extension collars shall be used to bring access covers and manhole covers to grade or at a minimum, within 12 inches of final grade. Septic tank access covers located at or above grade shall be lockable or designed to prevent entry by unauthorized persons, especially children.
- (5) Tanks shall have inlet and outlet baffles, sanitary tees or an effluent filter to prevent the passage of floating solids and to minimize disturbance of settled sludge or floating scum by wastewater entering and leaving the tank. Effluent filters and/or gas deflection baffles are strongly recommended to minimize solids loading of the absorption system. Inlet and outlet baffles shall extend a minimum of 12 inches and 14 inches, respectively, below the liquid level in tanks with a liquid depth of less than 40 inches, and 16 and 18 inches, respectively, in tanks with a liquid depth of 40 inches or greater. The horizontal distance between the outlet baffle and the outlet shall not exceed six (6) inches. Baffles shall be constructed of a durable material not subject to excessive corrosion, decay or cracking. Increasing the diameter of the vertical section of outlet

sanitary tees to more than four (4) inches is recommended to decrease up-flow velocity and potential discharge of suspended solids to the absorption system.

- (6) There shall be a minimum of one (1) inch clearance between the underside of the roof of the tank and the top of all baffles, and/or tees to permit venting of tank gases. Multi-chamber and multi-tank systems shall also be designed to permit venting of tank gases.
- (7) Tanks shall be placed on at least a three (3) inch bed of sand or pea gravel. This will provide for proper leveling and bearing. A five (5) inch bed of aggregate (3/4 to 1 1/2 inches in diameter) may be used in-lieu of the required three (3) inch bed of sand or pea gravel. Any additional or differing instructions or recommendations provided by the tank manufacturer shall also be followed.
- (8) There shall be a minimum drop in elevation of two (2) inches between the inverts (bottom of inside of pipe) of the inlet and outlet pipes.
- (9) Garbage grinders should not be installed; however, if planned to be installed or can reasonably be expected at the time of construction or in the future, an additional 250 gallons of capacity and seven (7) square feet of surface area are required. An effluent filter or gas deflection baffle or other acceptable outlet modification and a dual compartment tank or two tanks in series must also be provided.
- (10) Septic tanks may be forced toward the ground surface during cleaning or dewatering operations if they have been installed within the ground water zone. This is caused by the buoyancy effect of the displaced volume of the tank. Septic tanks installed in groundwater should be anchored to prevent "floating". Septic tanks installed in groundwater and not properly anchored should not be completely dewatered. Tanks constructed of fiberglass, plastic, or steel are more likely to float than reinforced concrete tanks because of their lighter weight per given volume; however, many lighter weight tanks have developed effective anchoring systems. All tanks should be installed in accordance with the manufacturer's recommendations.
- (11) Special care must be taken in bedding the house sewer drain line, septic tank, and outlet line to prevent uneven settlement and possible cracking or rupture where the inlet and outlet lines connect to the septic tank.

6.5 Multi-compartment Tanks or Tanks In-Series

Multiple compartments in a septic tank or tanks in-series results in improved retention of floatable and settleable solids. The second compartment or tank has reduced turbulence, velocity and instantaneous flow rates than would occur in a single compartment tank. Tank compartmentalization and outlet modifications (effluents filter and/or gas deflection device) will reduce the release of suspended solids and reduce risks of clogging the absorption system and are therefore highly recommended. A typical dual compartment septic tank is depicted in **Figure 7**.

- (1) Dual compartment tanks or two (2) tanks in series are recommended for all systems and shall be required when: (1) tanks have an interior length of ten (10) feet or more, (2) a mound system is

proposed, (3) an intermittent sand filter system is proposed, or (4) a garbage grinder can reasonably be expected to be used at the time of home construction or in the future.

- (2) The first compartment (inlet side) or first tank in series shall account for 60% to 75% of the total design volume.
- (3) The baffle separating the tank compartments shall extend from the bottom of the tank to at least six (6) inches above the invert of the outlet pipe. The baffle separating the tank compartments shall terminate at least one (1) inch below the underside of the tank roof to permit venting of tank gases.
- (4) Flow between compartments shall be controlled by openings located at a height to retain solids in the first compartment and sized to allow non-turbulent flow to the second compartment. This is typically accomplished by using: a four (4) inch vertical slot at least 18 inches in width, a six (6) inch elbow or two (2) four (4) inch elbows. The invert of the slot or elbow(s) shall be located at a distance below the liquid level equal to one-third (1/3) the distance between the invert of the outlet and the bottom of the tank.
- (5) Each compartment shall have at least one (1) manhole opening and a visual access opening above the inlet/outlet baffle. A manhole opening may replace a visual access opening. A manhole opening above the inlet/outlet baffle satisfies the requirement.
- (6) The volume and surface area needed to meet the requirements of **Table 3** shall be based upon the total volume and surface areas of all the tanks and chambers.
- (7) Tanks in series shall have a minimum drop in elevation of two (2) inches between the inverts of the inlet and outlet pipes within each tank. The tanks should be connected by a single pipe with a minimum diameter of four (4) inches and a minimum slope of 1/32 inch per foot.

6.6 Pre-cast Reinforced Concrete Septic Tanks

- (1) Concrete shall have a minimum compressive strength of 2,500 pounds per square inch (psi) at 28 days set. 3,000-psi concrete is recommended.
- (2) Wall thickness shall be a minimum of three (3) inches unless the design has been certified by a New York State licensed professional engineer (PE) as complying with all appropriate requirements for thin-wall construction. All walls, floor, roof and access covers shall contain reinforcing to assure support for 300 psf.
- (3) All joints and drain holes shall be sealed such that the tank is watertight.
- (4) Tanks with a joint below the liquid level must be tested for water tightness prior to backfilling.

6.7 Cast-in-place Concrete Septic Tanks

- (1) Concrete shall have a minimum compressive strength of 2,500 psi at 28 days set. 3,000-psi concrete is recommended.
- (2) The walls and floors shall be poured at the same time (monolithic pour).
- (3) The walls, floors and roof shall be at least three (3) inches thick with adequate reinforcing to assure support for 300 psf. Unreinforced walls and floor shall be a minimum thickness of six (6) inches.
- (4) Access covers shall contain reinforcing to assure support for 300 psf.
- (5) Tanks with a joint below the liquid level must be tested for water tightness prior to backfilling.

6.8 Fiberglass and Polyethylene Septic Tanks

- (1) All walls, floor, roof and access covers shall assure support for 300 psf.
- (2) Installation shall not occur in areas where the ground water level can rise to the level of the bottom of the septic tank unless the manufacturer has an installation feature or method, which prevents the tank from floating. The manufacturer's installation recommendations must be followed.
- (3) Particular care must be taken during installation, bedding and backfilling of these tanks to prevent damage to the tanks. The manufacturer's installation instructions shall be followed. These tanks are sometimes selected for installation in hard to reach sites due to the tank's lightweight.
- (4) All tanks should be sold by the manufacturer completely assembled. If a tank is delivered to a site in sections, all joints shall be sealed with watertight gaskets and shall be tested for water tightness after installation and prior to backfilling. Tanks with a joint below the liquid level must be tested for water tightness prior to backfilling.
- (5) The manufacturer or supplier should install inlet and outlet baffles or sanitary tees or the manufacturer shall provide appropriate tools, equipment and/or instructions for installing the inlet and outlet. The manufacturer's installation recommendations must be followed.

6.9 Steel Septic Tanks

- (1) All tanks must have a label indicating corrosion protection complying with Underwriters Laboratories, Inc. (UL), Standard UL-70 or equivalent.
- (2) Any damage to the interior or exterior tank coating must be refinished with an equivalent coating material prior to placement/backfilling since unprotected steel surfaces deteriorate rapidly from corrosion.

- (3) All walls, floor, roof and access covers shall assure support for 300 psf.

6.10 Septic Tank Certification and Water Tightness Testing

There are two (2) established methods used for determining septic tank water tightness:

- (1) Vacuum testing, which is a total tank integrity test (water tightness and structural), or
- (2) Water pressure testing (filling with water), which is recommended to be done onsite after installation.

ASTM International (formerly the American Society for Testing and Materials) has established standards and recommendations for construction and water tightness testing of concrete septic tanks, ASTM Standard C-1227. In general, the ASTM standard watertight testing procedures are as follows:

6.10.1 Vacuum Testing

Seal the empty tank and apply a vacuum to four (4) inches (100 mm) of mercury. The tank is approved if 90% of vacuum is held for two (2) minutes.

6.10.2 Water Pressure Testing

Seal the tank; fill with water, let stand for 24 hours. Refill the tank. The tank is approved if water level is held for 1-hour.

ASTM Standard C-1227 also contains many septic tank design and construction standards and recommendations similar to those established Appendix 75-A and this Handbook; however, the ASTM standard recommends that all tanks use dual compartments, flexible inlet/outlets, risers to the ground surface and the installation of effluent filters. Such septic tank design features enhance the performance of a septic tank and are highly recommended; however, these features are not required. For a copy of the ASTM standards go to <http://www.astm.org/>

The Precast Concrete Association of New York (PCANY) lists names of manufacturers whose products have been examined and tested by an independent Licensed Professional Engineer on their public website <http://www.pcany.org/>. The engineer certifies that the tanks have been tested for water tightness and structural strength, and comply with 75-A criteria. A red cast-in disk labeled “PCANY CERTIFIED” identifies these tanks. (*PCANY is not affiliated with the NYSDOH*).

6.11 Operation and Maintenance of Septic Tanks

Even the best designed and installed septic tank system will eventually fail to function properly without periodic maintenance. The result of inadequate septic tank maintenance can be clogging of the absorption area resulting in sewage backup into the home and/or untreated wastewater overflow onto the ground surface. Failure to periodically clean a septic tank most commonly causes clogging of soil surrounding the absorption field by excess solids leaving the septic tank. When this occurs, it is usually necessary to abandon and replace the absorption field or apply a remedial technology at great expense and inconvenience. Other possible causes of failure include use of septic tank additives, a change in ground water level, water line leaks, excessive water usage, excessive use of garbage grinders, dumping

grease down the drain, a change in surface water drainage, tank baffle failure or flushing materials not readily degraded or harmful products into septic tanks.

Appendix F includes a copy of the NYSDOH “Septic System Operation and Maintenance” pamphlet which provides general information on septic tanks and other OWTS components.

6.11.1 Septic Tank Inspections and Cleaning

Septic tanks should be inspected annually to determine scum and sludge accumulation. Most tanks should be pumped out every two (2) to three (3) years. Septic tanks need to be pumped out whenever the bottom of the scum layer is within three (3) inches of the bottom of the outlet baffle or sanitary tee, the top of the scum layer is close to the top of the outlet baffle or sanitary tee, or the top of the sludge accumulation is within ten (10) inches of the bottom of the outlet baffle or sanitary tee. A NYSDEC permitted septage waste transporter (septic tank pumper) should be employed to perform inspections to determine if pumping is necessary utilizing equipment such as a “sludge judge”. The pump-out clearances also apply to any chamber in multi-compartment tanks and to any tanks in-series; all tanks or chambers should be pumped out as soon as any one tank or chamber fails the minimum clearance.

In addition to inspecting for sludge and scum accumulation, the septic tank, baffles/tees, house sewer drain connection and tank outlet pipe should also be inspected. Some concrete baffles deteriorate over time. Baffles and tees that have deteriorated and no longer perform as designed must be replaced. Occasionally, winter ground frost will displace the house sewer drain line as it enters the septic tank or the effluent line between the septic tank and distribution box causing breakage of the lines at the septic tank wall. Cracked or broken lines must be repaired or replaced.

Septic tank cleaning is usually accomplished by pumping the contents of the septic tank into a septic tank pump truck. Only NYSDEC permitted waste transporters shall be engaged to pump out and dispose of septic tank contents. Septic tanks should not be washed or disinfected after being pumped out. A small quantity of sludge should be left in the tank to encourage continued bacteriological activity. “Seeding” new septic tanks with sludge is not necessary since adequate bacterial activity will commence promptly after sanitary wastes enter the tank.

6.11.2 Septic Tank Additives

Septic tank additives are not recommended. Additives are unnecessary for the proper operation of household systems and may cause the sludge and scum in the septic tank to be discharged to the absorption field resulting in premature failure. Some additives may actually pollute groundwater.

6.12 Grease Traps

Homeowners should always avoid dumping grease down the drain because properly sized and maintained septic tanks are capable of handling the normal production of household grease and fat without requiring a grease trap. Typically, grease traps require frequent cleaning. When grease traps are used, they need to be installed to handle only wastewater from grease generating fixtures (such as a kitchen sink) and sized to handle ½ of the household daily design flow rate to assure proper cooling of the wastewater to allow separation and retention of the grease in the trap. Venting of grease traps may also facilitate cooling of the wastewater. The grease trap effluent shall be discharged to the septic tank. Unless the amount of grease and fat discharged is unusually large from the dwelling, such as for a home catering operation, grease traps are typically not necessary for household wastewater discharges.

6.13 Abandoning/Decommissioning Septic Tanks

There are no NYSDOH regulations for abandoning/decommissioning septic system tanks and other system components (such as pump and siphon tanks, ETUs, cesspools, seepage pits, distribution boxes). Contact your LHD to check for local codes or guidance. In the absence of such local codes or guidance, the following is recommended: Whenever septic tanks or other system components are to be abandoned/decommissioned because public sewers are being installed or replacing a tank(s), the tank(s) and other system components can be removed and taken to a solid waste facility or decommissioned in-place. Septic system tanks must be properly decommissioned to minimize potential health and safety hazards. Contact your local solid waste management official to discuss options for proper disposal of the tanks and used absorption field soils, stone, pipe and other components. If the tank will be left in-place, a NYSDEC permitted waste transporter should pump out the tank, wash off, and remove as much residuals as possible. The use of lime as a disinfectant is an option for treating the tank(s) and absorption area and system components. Care should be taken when accessing and cleaning septic system tanks. Properly disconnect all alarms and electrical services, if any, from septic system tanks and other system components. The top of the tank should be knocked in and the bottom punctured, if possible, to allow for drainage of rain or surface water. Backfill the tank with sand or gravel to prevent a safety hazard. The area that was disturbed should be properly graded and seeded. If settling occurs over time, it may be necessary for additional fill material. Absorption field components (soils, pipe, aggregate, etc.) can be left in place unless local laws or codes require their removal. For the purpose of future home construction projects, property improvements and/or home sale, a record of the location of the abandoned/decommissioned septic tank and other components should be made.

TYPICAL SETTLING TANK CONSTRUCTION

NEW YORK STATE DEPARTMENT OF HEALTH
ALBANY, N. Y.

THOMAS PARRAN, JR., M.D.
Commissioner

RURAL WATER SUPPLY
AND
SEWAGE DISPOSAL SYSTEMS



BULLETIN NO. 28
Issued by
DIVISION OF SANITATION
C. A. HOLMQUIST, Director
EARL DEVENDORF, Associate Director
1922

PLAN

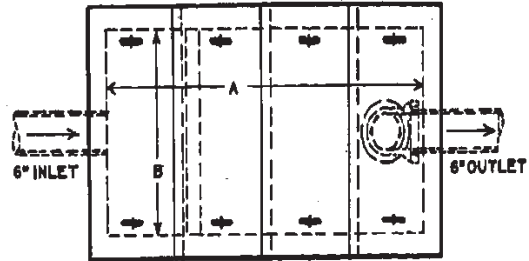

'A' SHOULD BE AT LEAST TWICE 'B'
BUT LESS THAN THREE TIMES 'B'
FOR A FAMILY OF 5 'A' WOULD BE 6' AND 'B' 3'

SECTIONAL ELEVATION

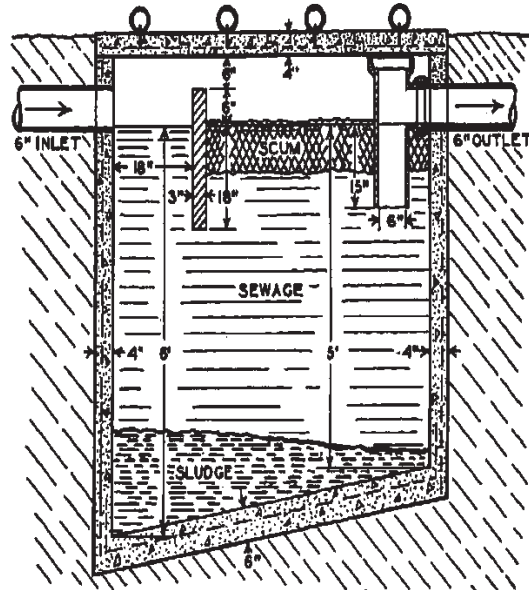

FIGURE 9

8 21

This diagram is for historical interest only. Do not use for plan or design preparation.

Chapter 7

Enhanced Treatment Units (ETUs)

7.1 General Information

Enhanced treatment units (ETU) are pre-treatment units that provide enhanced biological and physical treatment of wastewater that reduce the amount of organic content, measured as biochemical oxygen demand (BOD), and total suspended solids (TSS) prior to distribution to an absorption area. ETUs also reduce the amount of pathogens, viruses and other organic contaminants in the effluent. With reduced BOD and TSS the probability of biological “clogging” of absorption areas is greatly reduced.

ETUs create an environment for aerobic wastewater decomposing bacteria to thrive and multiply by mechanically mixing air (oxygen) into the wastewater to develop a “suspended growth” treatment process and/or by providing a large amount of surface area for bacteria to grow known as an “attached growth” or “fixed film” treatment process. The large population of aerobic decomposing bacteria results in rapid and improved biological decomposition of organic matter. ETUs are listed as Class I Standard 40 or Standard 245 units with NSF International (NSF). Class 1 Standard 40 units must meet effluent limits of 25mg/l BOD and 25mg/l TSS to be listed by NSF. Standard 245 units are also tested to meet Standard 40 criteria; these units are further certified to reduce nitrogen discharges. Nitrogen discharges must be decreased by at least 50% to be listed by NSF. ETUs are most often used for replacement or repair of failed systems where space is limited or enhanced treatment is necessary to help protect surface water or water supplies.

The volume of liquid wastewater discharged by ETUs is equal to the volume discharged by a properly sized septic tank. ETUs are generally much more expensive than a septic tank and typically require electrical power to operate the pump(s), air compressor(s), or other device(s). Regular maintenance of ETUs is imperative to assure proper system operation for effective long-term wastewater treatment and effluent quality.

To find units that are acceptable for use, go to the NSF website: <http://www.nsf.org/> and search for Class I, Standard 40 or Standard 245 wastewater treatment units. A typical “suspended growth” or mechanically aerated ETU is shown in **Figure 8** and a couple typical types of “attached growth” or media-based ETUs are shown in **Figure 9**.

7.2 ETUs for New Construction

ETUs may be designed, installed and maintained in new residential construction under the following conditions, as stipulated in Appendix 75-A.6 (6).

- (1) ETUs shall have a label indicating compliance with the standards for a Class I unit as described in the NSF Standard 40, Standard 245 or equivalent testing. The minimum rated daily capacity of these units shall be 400 gallons or the daily design flow as determined from **Table 1**, whichever is greater.

- (2) ETUs shall have an effluent filtering mechanism as part of the manufactured product or an effluent filter with a label indicating compliance with NSF Standard 46 or equivalent installed on the system outlet prior to discharge to the absorption area.
- (3) Unless otherwise specified, the absorption system that follows an ETU shall be designed in the same manner as for septic tank effluent.
- (4) Absorption areas receiving ETU effluent may be designed with a 33% reduction in the total absorption trench length. **Table 6E** lists adjusted total trench lengths for standard daily flows. Total trench length can be also calculated based upon reducing **Table 6B** trench lengths for non-standard daily flows by 33%. These trench length reductions are allowed when one of the following situations exist:
 - i. ETUs are subject to the jurisdiction of a Responsible Management Entity (RME), or
 - ii. Local sanitary codes or watershed rules or regulations incorporate the requirement to maintain and service the ETU in accordance with the manufacturer's recommendations.
- (5) The trench length reduction may only be used for conventional absorption trench systems and shallow absorption trench systems.
- (6) The trench length reduction shall not be further reduced by the trench length reduction allowed for qualifying gravelless systems (which are also allowed a trench length reduction). To restate, combining trench reduction credits for ETUs and gravelless systems is not allowed.
- (7) The trench length reduction for ETUs (and gravelless systems) is not applicable at properties located within the New York City Watershed.

7.3 ETUs for Repair or Replacement

ETUs produce a clarified effluent as compared to a septic tank and therefore are often an excellent option for repairing failing systems or replacing substandard systems on small lots or difficult sites and for protecting surface water and drinking water supplies. Due to the quality of the effluent, the needed soil absorption area can often be reduced or engineered to provide final treatment and dispersal within the limited space without creating a health or environmental hazard. Note that ETU effluent still contains small amounts of biological contaminants and nutrients that require aerated soil conditions for final treatment. Consequently, limiting conditions such as high water tables, bedrock or clay must still be taken into account.

Manufacturers of the units are a good source of information and recommendations on how, where and under what conditions such units can be effective. ETUs should be utilized in accordance with the manufacturer's recommendations. RMEs and/or local codes written to provide for oversight and enforcement are recommended when ETUs are being considered to ensure long-term effluent quality and ETU performance, including when used for system repairs, replacements or improvements. Note that local restrictions may limit the use of ETUs for repair or replacement purposes.

7.4 Operation and Maintenance of ETUs

Numerous ETUs and technologies are currently available to meet wastewater treatment needs. Without proper maintenance, however, these treatment systems and technologies will fail to perform as designed and efforts to protect public health and the environment will be compromised. This concept is true for all onsite systems; however, the use of ETUs and more complex soil distribution systems are typically used on difficult sites (for example small sites and/or poor soil conditions) or sensitive sites (such as lake side properties and/or compromised separation distances), making effective site evaluation, installation and continual maintenance of an ETU vital.

LHDs, Watershed Protection Agencies (WPA), or local communities considering the general use of ETUs to manage and solve OWTS issues consider the following concepts in developing a system approval and management program or local code development:

- Define program goals and requirements in codes
- Educate engineers, contractors and public on ETUs and codes
- Oversee site evaluation, design, construction and maintenance
- Provide system tracking, maintenance verification and record keeping
- Confirm availability of service providers for products to be used
- Establish adequate legal authority, enforcement mechanisms and compliance incentives

Many resources are available to assist parties interested in incorporating ETUs and/or management of OWTSs within their jurisdiction. The NYSDOH and LHDs will neither approve nor disapprove RMEs. Interested parties must consider what type of oversight, tracking and enforcement will work best for their needs. Valuable information and guidance is available through the USEPA, the Water Environment Research Foundation (WERF), the National Environmental Services Center (NESC), other States and other national organizations dedicated to onsite wastewater treatment system design and management.

http://www.epa.gov/owm/septic/pubs/septic_guidelines.pdf

http://www.werf.org/i/c/KnowledgeAreas/DecentralizedSystems/RMEsite/RMEs_2.aspx

<http://www.nesc.wvu.edu/index.cfm>

DETAILS OF A COMMERCIAL CHEMICAL TOILET

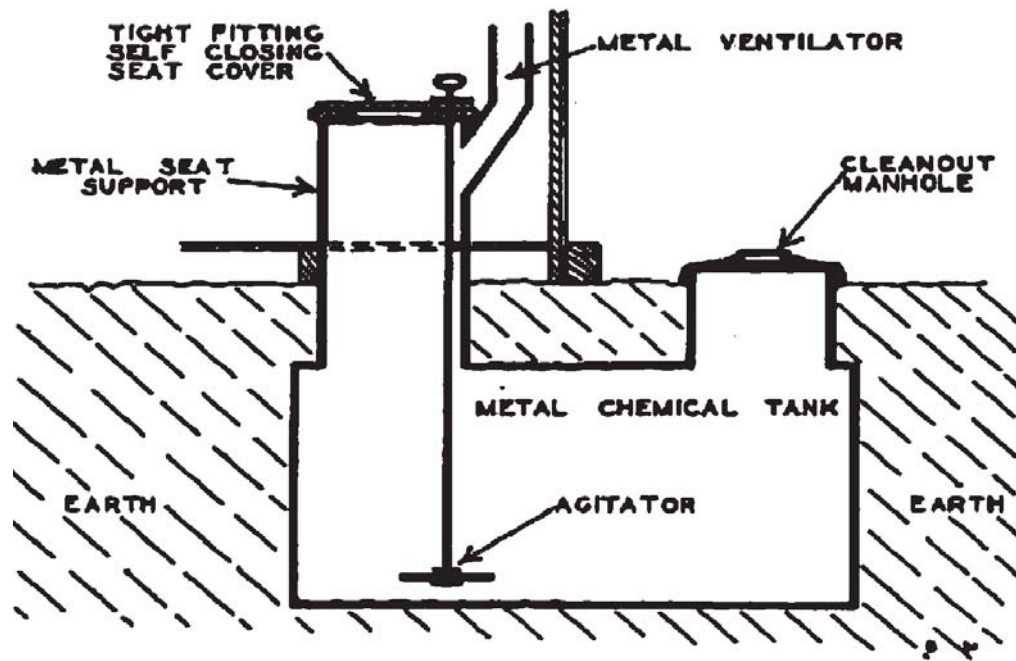

FIGURE 17

“Rural Water Supply and Sewage Disposal Systems”

C.A. Holmquist, Director, Division of Sanitation

NYSDOH

1932

This diagram is for historical interest only. Do not use for plan or design preparation.

Chapter 8

Wastewater Distribution and Devices

8.1 General Information

Septic tank or ETU effluent is conveyed to a subsurface absorption system comprised of a series of trenches, an absorption bed or other type of absorption system. Distribution of effluent is accomplished through a network of pipes connected to various types of distribution devices. For the OWTS to function properly the effluent must be equally distributed to the absorption area utilizing properly designed distribution devices and methods. Several types of distribution devices and methods may be used to perform this function. Distribution boxes are the most commonly used distribution device.

8.2 Distribution Box

A distribution box evenly distributes wastewater effluent to subsurface absorption areas or seepage pits. Piping conveying effluent from the septic tank or ETU by gravity to the distribution box shall be non-perforated (watertight), at least four (4) inches in diameter and installed with a minimum slope of 1/8 inch per foot. A typical distribution box is depicted in **Figure 10**. Distribution boxes should be inspected annually to assure that: (a) all outlet inverts are at the same elevation, (b) excessive solids are not flowing out of the septic tank or ETU, and (c) any required baffle is in place as designed. For accessibility, the top of the distribution box should be located not more than 12 inches below grade and have a removable cover. Where, due to site conditions, a distribution box must be more than 12 inches below grade, an extension collar shall be installed to bring the cover to within 12 inches of grade. The location of distribution box covers should be identified by installing a location stake. Such stakes permit rapid location for inspection and maintenance with minimal landscape disturbance.

To minimize frost action and reduce the possibility of movement after installation, distribution boxes should be set on a bed of sand or pea gravel at least 12 inches deep. The drop between inlet and outlet inverts shall be at least two (2) inches. A baffle is required at the inlet side of the box to prevent short-circuiting, especially when the slope of the pipe entering the box exceeds 1/2 inch per foot or when pump or siphon dosing is used. A partially truncated short sanitary tee or elbow with drilled aeration hole on the inlet and facing down may also be used as a baffle. The tee or elbow should allow absorption field gases to flow back to the septic tank and up the soil stack. When such short sanitary tees are used, a minimum of one (1) inch clearance between the underside of the distribution box cover and the top of the sanitary tee shall be provided to permit venting of absorption facility gases.

When wastewater enters a distribution box by gravity, the maximum length of each absorption field lateral (distribution line) connected to the distribution box shall be sixty (60) feet with the laterals installed with a slope of 1/16 to 1/32 inch per foot.

When wastewater is pumped into a distribution box through small diameter pipe (1.5 to 2 inches typically) then a short section (about 12 inches) of 4-inch diameter pipe entering the box can be installed to reduce the influent velocity. Distribution boxes may be used on sloped sites provided the inverts of the outlets are set at the same elevation and the first ten (10) feet of outlet lines have the same slope or if flow-equalizing devices are used.

The inverts of distribution box outlets shall be at least two (2) inches above the bottom of the box to prevent short-circuiting and reduce solids carry-over. Use of adjustable outlet flow equalizing devices is recommended in distribution boxes.

Distribution boxes may be constructed in place or purchased prefabricated. When concrete is used to construct boxes, it shall have a minimum compressive strength of 2,500 psi at 28-day set. Prefabricated boxes may be constructed of concrete, fiberglass or plastic. The boxes shall be installed in conformance with the manufacturer's instructions in addition to the above-noted requirements. Non-perforated pipe shall be used to connect the distribution box to the absorption trenches. The non-perforated pipe shall have a minimum slope of 1/32 inch per foot and be of tight joint construction on undisturbed earth or properly bedded throughout its length.

8.3 Serial Distribution

Serial distribution is used on sloped sites and comprises of the sequential flooding and eventual clogging (i.e., biomat buildup) of absorption trenches. The top trench is flooded first and any excess wastewater overflows to the next downslope trench. This proceeds sequentially to lower elevation trenches. Serial distribution is acceptable for use with dosing systems only. It is the least desirable of all methods since individual laterals cannot be periodically rested and wastewater is not uniformly distributed to all laterals. A typical serial distribution network is depicted in **Figure 11**.

Connections between distribution lines shall be non-perforated pipe of tight joint construction on undisturbed earth. Connections between successive pairs of laterals (e.g., 1 and 2, 2 and 3) need to be as far from each other as possible to prevent short-circuiting. The invert of the connection pipe exiting each trench shall be at least 12 inches below grade. The invert of the connection pipe exiting the uppermost trench shall be at least four (4) inches lower than the septic tank or ETU outlet invert.

8.4 Drop Boxes

Drop boxes are used on sloping sites to direct effluent to distribution lines parallel to site contours. Drop boxes are frequently used when the slope of the effluent pipe or non-perforated distributor pipe is $\geq 10\%$. The inverts of all outlets (located at the direct connections to distribution lines) within each drop box shall be at the same elevation to assure uniform distribution at a given contour line. The use of adjustable flow equalization devices is highly recommended. Inverts of outlets should be at least two (2) inches above the bottom of the drop box to prevent short-circuiting and reduce solids carry-over. The drop between the drop box inlet and distribution line inverts should routinely exceed two (2) inches. The drop between the drop box inlet and drop box overflow (the connection to the next drop box or distribution box) shall be at least one (1) inch and the slope of the connection pipe shall be at least 1/32 inch per foot. The invert of the overflow should be at least 1-1/4 inches above the outlet inverts. A typical drop box is depicted in **Figure 12**.

Drop boxes maximize flow to the uppermost absorption trenches and produce sequential trench distribution with the uppermost trenches being utilized until biomat buildup causes overflow to the next downgradient trench (es). System longevity can be improved by periodically resting any of the upper

laterals by replacing adjustable outlet levelers with plugs for a six (6) month period. When practicable extra trench (es) can be installed to allow trench use rotation and extend the system life. Utilization of drop boxes also provides access points for system inspection and expansion.

Baffles at the inlet end of the drop box are required to prevent short-circuiting and assure uniform flow to distribution lines. A modified PVC tee or elbow as described in Section 8.2 of this Handbook and depicted in **Figure 10** may also be used in drop boxes.

8.5 Pressure Distribution

Pressure distribution utilizes a wastewater effluent pump to convey septic tank or ETU effluent through a small diameter pipe network into the soil absorption area. A siphon may be used only if adequate slope exists to create sufficient pressure in the distribution network. The volume discharged in each cycle will exceed the volume available in the pipe network and will be discharged through small diameter orifices under low pressure. Pipe used in pressure distribution shall have a minimum diameter of one (1) inch and a maximum diameter of three (3) inches. The ends of all pipes shall be capped or looped and the distribution lines shall be installed level. Only pumps designated by the manufacturer for use as wastewater effluent pumps can be used (sump pumps are not appropriate and will quickly fail). Pressure distribution pumps shall be selected to maintain a minimum pressure of one (1) psi (this equals 2.3 feet of head) at the downstream end of each distribution line during the distribution cycle. Feet of head is often termed as “squirt” height and measured during field-testing. Squirt height refers to the height water travels when orifices are turned up and the pump is activated to test the distribution system before backfilling. A distribution box shall not be used for pressure distribution.

Pressure distribution permits rapid distribution of septic tank or ETU effluent throughout the absorption system followed by a rest period during which no effluent enters the absorption area. Periodic application of wastewater to absorption facilities is accomplished by means of a pump or siphon (only if adequate slope is available) installed in a dosing tank. A typical dosing tank with a siphon is shown in **Figure 13** and typical dosing tank with an electric effluent pump is shown in **Figure 14**. Pressure distribution assures that absorption area is fully and uniformly utilized. The maximum length for each absorption line used in conjunction with pressure distribution is 100 feet. The 100 feet for an end-manifold distribution network is shown in **Figure 15** and 100 feet in each direction from a central-manifold distribution network as shown in **Figure 16**.

Pressure distribution systems should be designed to minimize head loss due to friction in the distribution network. Excessive head loss in the distribution network causes unequal application of effluent to the absorption facility. Distribution lateral pipe should be designed to limit differences in flows at the distal orifice and the supply end orifice (the manifold end) to 10% of the distal orifice flow (for example, 0.10 gpm and ≤ 0.11 gpm). Distribution manifold pipe should be designed to limit the difference in head between the distal and supply ends to 10% of the distal end head (such as 1.0 and 1.1 psi). The lateral pipe volume determines the minimum dose volume. Sufficient volume, however, needs to be applied to distribute the effluent uniformly across the network. Thus, net dose volume should be about 5 times the lateral pipe volume with not over 20% of the design volume per dose. The total dose volume is based on the net dose volume plus the flow back (non-perforated feed pipe).

Table 5 lists the void volume for various diameter pipes. **Appendix A** contains example mound designs with pressure distribution network calculations and includes tables with recommended pressure pipe diameters for various orifice diameters, orifice spacing, and maximum lateral lengths.

Over time, the distal end of distribution laterals or orifices may become partially clogged with biological growth or suspended and settleable solids that were discharged. Wastewater fungal growths,

which slough off pump chamber surfaces and distribution pipes, also increase the clogging effect. Special provisions for periodically flushing distribution laterals need to be incorporated into the design of pressure distribution systems. Pressure distribution line flushing should occur when septic tanks are pumped or as needed.

Distribution laterals may be designed with individual valves near the distribution manifold end to enable maintenance and the ability to direct flow to individual laterals for flushing. Valves should be installed in low profile boxes for easy access. Turn-ups (i.e., 90-degree pipe “sweeps” or two, 45-degree fittings with vertical riser) should be installed at the distal ends of laterals to accommodate flushing and cleaning. Schedule 40 pipe is recommended for the pressure pipe network including the turn-ups. Turn-ups should be protected with sleeves of larger diameter pipe or other method and both should terminate at grade or as near grade as possible. Turn-ups must be capped and sealed with Teflon tape or other method on the riser threads to prevent leakage.

Flushing can be accomplished by pumping water through each individual lateral utilizing a dedicated hose running back to the inlet end of the pumped out septic tank. The pump chamber should be filled with water to the high water level immediately prior to activating the pump for lateral flushing. The low water level pump-stop sensor should be operational during lateral flushing to prevent damage to the pump. Lateral flushing should continue until return water is relatively free of large solids. Trucked in water is the preferred source of flushing water for filling the pump chamber. If a hose connected to the household water system is used to fill the pump chamber, the hose shall not contact the chamber contents to avoid contamination of the water supply (an air break needs to be maintained between the discharge end of the hose and the pump chamber).

Except for absorption bed systems, conventional OWTs do not normally require pressure distribution. Pressure distribution may be beneficial for distribution in slowly permeable soils and alternative type systems where even distribution and resting periods are critical to the performance of the system. When pressure distribution is used, the design professional should supervise construction, prepare an operating manual or instructions and implement start-up.

8.6 Dosing

Dosing involves the use of a wastewater effluent pump or siphon to move the effluent into the distribution pipe network. Upon activation, an effluent pump or siphon sends a calculated “dose” of wastewater to a distribution box. Distribution to the absorption system is by gravity from the distribution box. The perforated distribution lines shall be installed as level as possible. The volume of effluent in each dose should be 75% to 85% of the volume available in the distribution pipe network. Pump control floats are set to achieve this volume. Siphons shall be installed so the drawdown volume meets the required dose volume range. The use of manually operated siphons or pumps is not acceptable. Dosing or pressure distribution is recommended for all absorption systems since it promotes improved treatment of wastewater and system longevity. **Table 5** lists the void volume for various size pipes and contains an example dosing volume calculation.

Dosing is required for conventional absorption areas that exceed a total absorption trench length of 500 feet. An alternate dosing arrangement is required when the total absorption trench length exceeds 1,000 feet. Alternate dosing devices have the capability of dosing two (2) separate sections of an absorption area by having two (2) pumps or siphons, or other device to rotate dosing to separate areas. When duplex pumps are used in-lieu-of a single pump with one day's reserve storage capacity in alternate dosing, duplex pumps with individual alarms shall replace each single pump.

Since dosing siphons are equipped with an overflow pipe, any reserve storage capacity serves no useful purpose. Dosing siphons should be inspected periodically to assure that the wastewater level in the storage chamber is within its normal operating range (for example, bottom of bell to below the overflow). An audible and/or visual alarm, located in a conspicuous place and readily accessible, is recommended to indicate that the siphon chamber is overflowing. Dosing siphons should be equipped with a downward facing screened vent riser to reduce the concentration of explosive and/or toxic gases within the unit. Upon installation, new siphons should be primed with water. If hydraulic bell siphons are used, they can be tested for leaks by covering them with water and inspecting for air bubbles.

Float switches controlling effluent pumps should be tested and adjusted for correct discharge level. Pumps and floats must be readily accessible for servicing. Pumps and control devices within a dosing tank shall be of an explosion proof design. Manufacturer's directions must be carefully followed in the installation of siphons and pumps. A design professional should supervise the installation of siphons and pumps and should certify that installation was in accord with approved plans and manufacturer's recommendations.

Dosing or pressure distribution to proprietary products such as gravelless systems or ETUs should be designed in accordance with manufacturer's recommendations and applying the fundamental dosing and pressure distribution concepts discussed in this Handbook.

8.7 Timed Dosing

Timed dosing is another method to control effluent distribution to an absorption field. It differs from on-demand dosing systems that discharge as wastewater accumulates in the pump tank until the float activates the pump. Timed dosing involves incorporating a programmable timer to activate the pump on a "timed" basis to distribute smaller doses equalized over an entire day. This reduces peak flows into the absorption field and promotes unsaturated conditions in the absorption area soils. If time dosing is used, the pump chamber must have sufficient surge capacity to store peak flows. In general, timed dosing will target twelve (12) doses per day and the dose volume is based upon the design daily flow. This may need to be adjusted based upon actual water use.

Dosing or pressure distribution is recommended for all systems as it promotes better treatment of wastewater by allowing rest periods between receiving effluent and keeping the trenches unsaturated and aerated which promotes system longevity. Timed dosing is the best method for controlling effluent distribution; it minimizes flooding of the absorption system and maximizes rest periods between doses, which results in maintaining unsaturated/aerated conditions.

8.8 Pump or Siphon Chambers

Pump chambers shall be equipped with an audible and/or visual alarm located in a conspicuous location to alert homeowners of a pump malfunction. Pump chambers shall not be equipped with an overflow pipe. Pump chambers should be equipped with a downward facing screened vent riser to reduce the concentration of explosive and toxic gases within the chamber. Pump chambers shall be sized to provide a minimum reserve storage capacity of one day's daily design flow above the alarm level. The purpose of the reserve storage capacity is to prevent a nuisance from occurring (a backup into the house) and enable continued use of sanitary facilities while the malfunctioning pump is repaired or replaced. A typical dosing tank with an electric effluent pump and reserve storage volume is shown in Figure 14. Use of household sanitary facilities and water in general should be minimized until the pump is repaired or replaced

One day's storage available is preferred; however, duplex pumps with individual audible or visual alarms may be used in-lieu-of a single effluent pump and one day's reserve storage capacity. Immediate repair or replacement is necessary whenever either of the pumps malfunction. High groundwater conditions or shallow depth to bedrock may cause duplex pump installations to be selected in-lieu-of a single pump with one day's storage.

Pump stations installed below the maximum ground water table are subject to the buoyancy effect of the displaced volume of the station. Any buoyancy effect shall be addressed in the design of pump stations (for instance, anchoring) to prevent damage to the inlet and outlet piping and the pump station integrity. Pump chambers and connecting plumbing shall be watertight to prevent ground water contamination in the vicinity of the pump station or infiltration of ground water or surface water run-off into the pump station.

Where the discharge pipe is not buried below the frost line the pipe should be drained between doses or properly insulated. Draining the pump discharge line (force main) back into the pump chamber between doses is preferred over insulating. Draining the force main can be accomplished by; (a) using a solenoid valve to control discharge with the solenoid valve being open when the pump is off and closed when the pump is operating, (b) eliminating the check valve at the pump if the pump/motor is not subject to damage by operating in reverse, or (c) most commonly, providing a "weep hole" in the pump discharge line inside the tank and downstream from the pump check valve.

Siphon or pump tank access covers that are located at or above grade shall be locked to prevent entry by unauthorized persons, especially children. Siphon or pump tank access covers should be located at or above grade to facilitate operation, maintenance, repair or replacement of equipment as required. The pump system should be designed to allow quick and easy replacement of the pump(s) without entering the tank. A DEC permitted septage hauler should empty the pump tank before the pump is replaced or repaired to avoid overloading the absorption area with the entire accumulated contents of the pump chamber when the pump is reactivated. Discharge of wastewater accumulated in the pump tank onto the ground surface is not acceptable. Access covers should exclude precipitation from entering the tank and site grading should convey surface runoff away from access covers. Safety precautions applicable to inspecting septic tanks are also applicable to inspecting pump or siphon tanks.

In case of a power outage react similar to when a pump malfunction occurs by minimizing use of household sanitary facilities and water in general until the power is restored since the effluent pump will not function. Special care is warranted for households served by public water supply since water service may remain available during power outages. A solenoid valve on the water supply service line may be warranted to discontinue water service during electrical power outages or have the capability to connect the effluent pump to a portable or whole house generator. The volume of wastewater pumped per dosing cycle should not exceed the daily design flow to prevent overdosing; therefore, the volume pumped out should be controlled following electrical power outages or pump malfunction and when storage buildup has occurred in the pump chamber. The volume pumped can be controlled by: (a) manually via an on-off switch on the pump coupled with the calculated maximum time of pumping or (b) automatically via an overriding timer switch built into the pump controls. A minimum two (2) hour rest period should occur between pumping cycles. Alternatively, a DEC permitted septage waste transporter can empty the pump chamber to prevent overdosing the absorption area.

Chapter 9

Subsurface Onsite Wastewater Treatment Systems

9.1 General Information

Discharges to surface waters are not acceptable for any new residential OWTS. Replacement and upgrading of some failing systems may necessitate use of a surface discharge with all appropriate controls (NYSDEC SPDES permit, seasonal or year-round disinfection, monitoring, reporting, etc.). In such rare circumstances, NYSDEC has jurisdiction over all discharges to surface waters and that agency or its agents may approve such discharges. Discharges to the ground surface or roadway ditches are also not acceptable and are considered a public health nuisance or public health hazard.

Although septic tanks, sand filters and ETUs improve the quality of wastewater effluent, the effluent still contains pollutants and harmful organisms and is not suitable for direct discharge to surface waters or ground waters. Subsurface soil absorption areas are designed to filter and oxidize harmful organisms and most dissolved and suspended solids in the wastewater effluent. Absorption systems should not be constructed directly over visible cracks, crevices, depressions, sinkholes, flood prone areas or other site conditions not conducive to wastewater treatment systems. Surface water should always be diverted from the vicinity of the OWTS components and the absorption area.

The specific type of OWTS that can be used depends largely upon soil and site conditions. The most common systems are conventional absorption trenches or beds. Alternative subsurface treatment systems (raised system, mound and intermittent sand filter) can be used when site conditions do not allow the use of conventional subsurface treatment systems. Care is essential when installing any system to assure protection of water supplies, ground water and surface water. Site requirements for various types of OWTSs are shown in **Table 4**.

9.1.1 Nutrients (Phosphorus and Nitrogen)

When the absorption fields are kept shallow, the vegetative cover root system can penetrate and take up some of the phosphorus and nitrogen during the growing season. When absorption fields are installed to maximize travel through unsaturated soils, particularly loam soils, most of the phosphorus in the effluent will be removed through soil adsorption. By utilizing shallow trenches and maximizing travel time through soil, the possibility of phosphates and nitrates migrating to the ground water table and contributing significant quantities of nutrients to a lake or stream can be greatly minimized. This is particularly so when considered in relation to the phosphorus and nitrogen contributions from surface runoff, storm water and direct wastewater discharges to lakes and streams. To promote adequate removal of these nutrients, other pollutants and pathogenic organisms, at least two (2) feet of useable soil shall exist between the bottom of absorption trenches and the highest ground water level, bedrock or

other impermeable strata. For seepage pits, a minimum three (3) foot separation is required between the bottom of a seepage pit and these boundary conditions.

Certain unique local conditions may dictate the imposition of greater separation distances or other mitigative measures. This includes consideration of greater separation distances when locating absorption facilities above limestone, karst or shale recharge areas and particularly where the ground water aquifer under these formations is a source of water supply.

9.1.2 Nitrogen Reducing ETUs

NSF provides third party testing of wastewater treatment units that provide a reduction in the total nitrogen in effluent. NSF Standard 245 Class I units are nitrogen reducing ETUs. Note that these units are not tested to determine phosphorus level reductions. Standard 245 units must also meet testing required for Standard 40, Class I units for BOD and TSS. These units may be beneficial to specific areas or sensitive water bodies where nitrogen loading is a concern. Nitrogen effluent levels are required to be reduced by at least 50% from these units. Note that OWTs are typically only a fraction of the nutrient loading source within a watershed. Addressing nutrient loadings to water bodies should be a watershed-wide approach to address all sources of nutrient loadings (including farming, run-off, lawn fertilizing, etc.).

9.2 Absorption System Location

Careful selection of the absorption system location will minimize the chance of future malfunction. The daily discharge of hundreds of gallons of wastewater effluent at each household poses a potential threat of contamination. Absorption systems should be located far from wells and watercourses to minimize the chance of contamination. The minimum distances that OWTs components and absorption areas shall be separated from other facilities are listed in **Table 2** and shown **Figures 1** and **Figure 2**. The separation distances to the absorption areas include the designated reserve area for system expansion or repair, when available.

Some sites and circumstances may warrant the pumping of wastewater to a suitable location in order to achieve required separation distances. In such cases, consideration should also be given to designing a system that is easily accessible for maintenance and repairs. Pressure distribution or dosing should be incorporated into all systems that require pumping to reach suitable locations because of the treatment benefits achieved by dosing.

Consideration should also be given to prevent future home improvements from interfering with the operation of the absorption system. Impermeable surfaces and surfaces subject to heavy loads such as driveways, sidewalks, portions of buildings, parking lots or swimming pools should not be constructed upon or in absorption fields. Where paving over or covering an absorption area is necessary, the absorption area should be equipped with a downward facing screened vent riser or other method to assure oxygen exchange to the absorption facility. The absorption facility shall also be designed to withstand any physical load(s) to be imposed. In such cases, the use of an ETU may also be incorporated to reduce levels of BOD and TSS to the absorption area to help offset the reduced aeration within the absorption area. The location of a system under an impervious area should only be considered as a last resort and will require a specific waiver from the LHD or approval from the local authority having jurisdiction.

Absorption system location and special household plumbing options should be considered if public sewers can reasonably be expected to become available in the future. If the system cannot be

constructed in front of a home, the home's internal plumbing should be designed to facilitate the public sewer connection. Installation of a dry house sewer line at the time of home construction will eliminate a costly future re-plumbing for the sewer connection and is highly recommended whenever public sewers are anticipated or planned.

9.3 Subsurface Drainage and Water Table Control

Subsurface drainage control facilities such as curtain drains, vertical drains or interceptor drains may be installed to control shallow lateral groundwater flow or perched water tables in the vicinity of existing or proposed subsurface treatment facilities as depicted in **Figures 19, 19A and 19B**. Separation distances between subsurface drainage facilities and treatment system components in level terrain should equal **Table 2** values for a "Stream, Lake, Watercourse (b), or Wetland" to prevent short-circuiting to the watercourse receiving the subsurface drainage facility discharge. Short-circuiting of wastewater from absorption facilities to drainage facilities must be avoided. Drainage of artesian fed water tables or slow-moving, unconfined water tables are not recommended or practicable. Technical assistance with subsurface drainage control facilities may also be requested from soil scientists, geologists, design professionals, LHDs or other qualified personnel.

The ground water collection portion of subsurface drainage facilities on sites with $\geq 5\%$ slope should be at least fifteen (15) feet upslope of wastewater absorption facilities to provide effective ground water dewatering and prevent short-circuiting of wastewater to the subsurface drainage system. If the difference in elevation between the bottom of the ground water collection facility and the top of the uppermost wastewater absorption trench or bed exceeds ten (10) feet, the minimum horizontal separation should be 1.5 times the vertical difference for $\geq 5\%$ sloped sites. The upslope horizontal separation distance from the absorption area should be increased at least five (5) feet for each 1% reduction in slope of the site (≥ 20 feet for 4%, ≥ 25 feet for 3%, ≥ 30 feet for 2%, and ≥ 35 feet for 1%). For $< 1\%$ slope, the horizontal separation should be 100 feet. The surface outlet of a subsurface drainage facility should be located as far away from the absorption area as necessary to not affect the system functionality, and shall not be less than 20 feet.

Curtain drains may be installed upslope of proposed absorption facilities on sloped sites to intercept and control high ground water. Non-perforated, watertight pipe installed on in-situ soil bedding at least ten (10) feet from the absorption facility should be constructed to convey the collected ground water to the ground surface as depicted in **Figure 19A**. The surface outlet should be protected from water infiltration, soil erosion and animal entry as depicted in **Figure 19B**. The upstream end of all perforated and non-perforated segments of curtain and/or footing drains should be fitted with capped cleanouts to facilitate future cleaning. Cleanouts are most apt to be needed when non-granular soils are drained/dewatered.

The useful life of subsurface drainage facilities in granular soils is markedly increased by proper installation of permeable geotextile surrounding the aggregate. Subsurface drainage aggregate (washed number 2 stone or gravel) in granular soils should be surrounded by permeable non-woven geotextile to prevent siltation and plugging of the aggregate and drain pipes as depicted in **Figure 19**. Aggregate should surround the perforated drainpipe and extend above the existing high water table to avoid ground water bridging over the subsurface drainage system.

Subsurface drainage in fine-grained soils (silt and/or clay) should be accomplished with washed coarse sand and aggregate envelope surrounding the perforated drainpipe as depicted in **Figure 19**. Permeable geotextile should not be used to fully surround the coarse sand and/or aggregate in soils with a high silt or clay content to avoid plugging the geotextile.

Wastewater short-circuiting from absorption facilities to watercourses via household foundation drains should also be avoided by using appropriate separation distances. Use of impermeable barriers such as clay or plastic sheeting should be considered to prevent short-circuiting when absorption facilities must be located close to foundation drains and the foundation drains should be treated the same as curtain drains. When curtain and/or footing drains are located downslope and in the direct path of flow from the wastewater absorption facilities, the recommended minimum separation distance between wastewater absorption facilities and downslope curtain and/or footing drains is 100 feet to prevent short-circuiting of wastewater to the ground surface from the drainage facility outlets. This separation distance may be reduced to no less than 50 feet when: the soil percolation rate is five (5) to 60 minutes per inch and the minimum vertical separation distance from the bottom of any absorption trench to high ground water, bedrock, or impermeable soil is at least four (4) feet. The recommended minimum separation distance is not applicable to footing drains located above seasonal high ground water. The effectiveness of subsurface drainage systems should be determined via periodic monitoring during the wet season (March 15 - June 30) following installation of the system.

The effectiveness of the subsurface drainage system (lowering of water table) must be demonstrated prior to installation of the wastewater absorption system when any of the three (3) following site conditions exist:

- 1) The site slope is less than 5%, or
- 2) The soil percolation rate is slower than 30 minutes per inch, or
- 3) The bottom of the proposed drainage system is not in contact with the impermeable strata that is causing the high ground water condition.

Washed sand and aggregate drainage facilities that are not surrounded by permeable geotextile should be at a minimum covered with a permeable geotextile to minimize entrance of backfill soil into the drainage system. Backfill should be comprised of finely textured soil to minimize entrance of surface water into the subsurface drainage system. Breathers or vents may be needed for proper functioning of long drainage systems.

Minimum slope for four (4) inch diameter drainage pipe is generally 0.004 feet per foot. The minimum pour distance (defined as the drain outlet invert to normal low water surface or outlet channel bottom) should be one (1) foot for drainpipe slopes up to 4%.

Only perforated drainage pipe with perforations completely around the pipe wall should be used. Wastewater distribution pipe should not be used for drainage systems. Trees and shrubs should not be present near the drainage collection system to avoid root interference. Root systems of many trees and shrubs extend beyond the tree or shrub drip line (tips of branches).

The drain outlet should be at least eight (8) to ten (10) feet of rigid, non-perforated conduit (metal, schedule 40 PVC or equal). At least two-thirds (2/3) of the length of the outlet conduit shall be installed in soil and backfilled with at least two (2) feet of soil to prevent leakage, slippage or freezing.

9.4 Stabilization of Disturbed Soil and Fill Material

An absorption system shall not be built in unstabilized fill material or disturbed soil. Where absorption facilities are to be constructed in fill or disturbed soils, the soil shall be permitted to stabilize by natural settlement for a period of at least six (6) months, including a freeze-thaw cycle, before soil characterization is performed. Stabilization by mechanical compaction in shallow lifts [approximately

six (6) inches] can be performed if a fill material consisting of only granular sand or sandy loam is used. Mechanical compaction can be achieved via track type machines (bulldozer or front-end loader with downward blade/bucket pressure) or steel wheeled roller. Fill material to be used in a raised system or mound should undergo percolation tests at an undisturbed location at the borrow pit and shall be re-evaluated after stabilization of the fill to confirm a percolation rate of five (5) to thirty (30) minutes per inch. Granular sand or sandy loam with a percolation rate of about five (5) to ten (10) minutes per inch is preferred because the material is less likely to compact and will therefore maintain its ability to transmit liquid.

Heavy construction equipment shall not be used in or immediately downslope of raised system or mound areas to avoid compaction of the native soil where treated wastewater dispersal will occur. In general, areas to be used for an absorption system should not be disturbed or disturbed as little as possible.

9.5 Choice of Onsite Wastewater Treatment Systems

Conventional absorption trench systems, as shown in **Figures 17 and 18**, are the recommended treatment systems in well-drained areas with a low groundwater table and where the upper soils possess adequate percolation. Conventional absorption trenches laid parallel to one another and connected to a distribution box are commonly used in relatively flat areas while drop boxes and serial distribution laterals are frequently used where land slopes of 10% or more exist. At any site, absorption trenches shall be constructed parallel to the ground contours.

An absorption bed, as shown in **Figures 18 and 26**, though less desirable than trenches due to reduced sidewall area, may be considered on some sites. Construction of the bed can be quite difficult. A backhoe can straddle a trench during absorption trench construction and leave the infiltrative surfaces undisturbed in terms of compaction. Construction equipment, however, should not be permitted to operate within the area designated for an absorption bed and the sidewall area of the bed should be maximized for the system to perform properly. For these two (2) reasons, a bed wider than 20 feet should not be considered. If a system is designed with multiple beds, a minimum separation of ten (10) feet of undisturbed soil should be provided between the sidewalls of the beds.

The least desirable of all systems is the seepage pit. Seepage pits do not provide even distribution of effluent over the design absorption area and the pit design and construction features (concrete top and installed depth) reduce the opportunity for oxygen exchange at the active infiltrative surface. This leads to reduced treatment of wastewater as compared to absorption trenches and other absorption areas that are designed to promote air exchange. Seepage pits may not be used where trench systems are feasible. Seepage pits should not be used where drinking water is obtained from nearby shallow drinking water sources or where subsoil is a coarse sand and/or gravel.

High ground water, periodic flooding, impermeable soils, inadequate permeable soil depth or shallow depth to bedrock is some reasons for discouraging or prohibiting use of conventional absorption systems. Alternative system designs and/or site mitigation techniques may need to be utilized to overcome some of these site constraints. Site modifications to alter site soil conditions, control ground water, alter slope, alter drainage patterns or increase separation distances to boundary conditions should be conducted under the supervision of a design professional.

9.6 Site Modification to Accommodate Onsite Wastewater Treatment Systems

Sometimes site conditions such as insufficient useable soil, high water table or excessive slope exist that do not allow for proper siting of an OWTS in accordance with Appendix 75-A standards. In some cases sites can be “modified” using fill material and/or construction techniques to create site conditions that allow for proper wastewater treatment and dispersal. Contact the local health department or other local authority having jurisdiction before considering any of the following site modification options. Modification of a site without first contacting the local jurisdictional office is at the owner’s risk and does not assure site approval.

9.6.1 Clay Barrier Protecting Bedrock Recharge Aquifers

Absorption systems should not be constructed directly over visible bedrock, cracks, crevices, depressions, sinkholes or other susceptible geologic formations to protect the aquifer. In very rare cases, an alternative method of protecting bedrock aquifers comprises installation of a six (6) inch clay barrier installed on the in situ soil/rock beneath the proposed absorption area and extending radially as described as follows. On slopes of less than 1%, the clay layer covered with at least one (1) foot of useable soil (1 to 60 minutes/inch) should extend 100 feet radially from the toe of the absorption area including the projected expansion area. On slopes of one to 15%, the clay layer covered with at least one foot of useable soil should extend radially from the toe of the absorption area including the projected expansion area 100 feet in the downslope direction, 25 feet parallel to contours, and 20 feet in the upslope direction. At least four (4) feet of useable soil should be installed above the clay layer in the proposed absorption area including the projected expansion area. Fill slopes shall not exceed one (1) vertical to three (3) horizontal. A design professional should supervise the above-noted system construction and certify that construction was in accord with approved plans.

9.6.2 Limited Surficial Useable Soil

A site modification option for sites with only six (6) inches of in-situ useable soil and slopes not exceeding 15% may be modified to accommodate a conventional absorption trench system. This site modification, involves the placement of an extensive amount of stabilized fill material with a percolation rate of between 5 and 30 minutes per inch on the site. Once the fill material is stabilized, a conventional absorption trench system is constructed in the fill. The aerial and depth limits of fill are such to provide a filled area of four (4) feet in depth above vertical boundary conditions and extending 100 feet down slope in the direction of flow (site contours). This creates a site condition where effluent must travel vertically through at least two (2) feet of useable soil and horizontally through at least 100 feet of useable soil to ensure adequate filtration and treatment. Other systems allowed on similar site conditions (intermittent sand filters and mounds) provide an added level of protection using smaller absorption areas because they utilize specified sand and pressure distribution to enhance wastewater treatment prior to distribution to in-situ soils.

The depth of useable soil (in-situ soil plus fill material) shall be at least 4-feet for the proposed absorption system and the reserve area. A 12-inch depth of useable soil shall extend 100 feet in the direction of wastewater dispersal from the absorption system and reserve area. Fill material tapers shall extend 25 feet parallel to contours and 20 feet upslope for sites with slopes of 1 to 15 %. For flat sites with slope of less than one 1%, the fill material shall extend 100 feet radially around the absorption area. A site modification using fill material is depicted in **Figures 38 and 38A**.

A system shall not be built on sites with seasonal high groundwater unless the owner can demonstrate improvements that will divert groundwater from system and prevent any saturation of the fill material. A system shall not be constructed on parcels where there are less than six (6) inches of naturally occurring soils from original grade to solid bedrock. System shall not be constructed on parcels where fractured bedrock exists at grade or within two (2) feet of original grade.

A system shall not be built in unstabilized fill material. Deep hole and percolation tests must be conducted in the stabilized fill during the normal high ground water period since mottling is not applicable to recently filled sites. A conventional trench design shall be designed based upon the stabilized fill material percolation rate.

9.6.3 Very Fast Percolating Soils

Soils with very fast soil percolation rates (i.e., less than one (1) minute per inch) are not suitable for conventional absorption systems. Very fast percolation rate soils do not provide adequate treatment of wastewater because the effluent moves too quickly through the soil and may reach ground water before being fully treated. Where soils exhibit a percolation rate faster than one (1) minute per inch and all horizontal and vertical boundary conditions are met, the site may be modified via a special cut and fill system. All soil bounded by two (2) feet from the proposed absorption trenches (i.e., horizontally and vertically) shall be removed and replaced by a known soil type or the in-situ soil can be blended with a slower percolating soil to slow down the soil percolation around and below the absorption area.

Imported or blended soil with a percolation rate of five (5) to sixty (60) minutes per inch can be used; however, a soil with percolation rate of five (5) to ten (10) minutes per inch is preferred. Stabilization by mechanical compaction can be performed if the imported or blended material consists of only granular sand or sandy loam. Soil should be replaced in six (6) inch layers with mechanical compaction to the approximate density of the on-site soil. Care must be taken to not overly compact the soils. Additional percolation tests may be performed on each soil layer as they are being compacted. Oversight by the design professional during this process is suggested. Other soil types should be stabilized by natural settlement for a period of at least six (6) months, including a freeze-thaw cycle. Percolation tests of the replacement soil or stabilized blended soil coupled with proposed daily flow rates shall be used to select the total lineal footage of distribution pipe needed. Conventional absorption trenches shall be constructed in the replaced soil. The vertical and horizontal separation distances noted in **Figures 1, Figure 17 and Table 2** shall also be met. Replacing soil with imported granular sand or sandy loam soil with a percolation rate of five (5) to ten (10) minutes per inch range is the preferred method of soil replacement over soil blending. It is difficult to properly blend soils (cement mixer or backhoe), particularly soils with some clay or silt content. A site modification for very fast soils is depicted in **Figure 37**.

9.6.4 Sloping Sites

Appendix 75-A states that “Slopes greater than 15% are ... unacceptable.” Therefore, any site that will be developed with a slope greater than 15% will require the granting of a specific waiver or other approval by the LHD. Consequently, before installation on sites with slopes greater than 15% begins (which may include site modification), the LHD or local authority having jurisdiction should be contacted to determine if the proposal is acceptable or if plans/permits are needed. Sites with existing slopes exceeding 20% should not normally be considered for residential OWTSS; however, development following mining represents one exception (conversion of hillsides, eskers, etc., to relatively level sites). The 15% slope limitation established in Appendix 75-A for construction of subsurface treatment

systems applies only to the portion of the lot to be used for the proposed absorption facility plus the designated reserve area, and not to the entire lot.

Sites with at least one (1) foot of unsaturated permeable soils and slopes not exceeding 20% may be modified by grading (for example cut and/or fill) to meet the maximum 15% slope requirement. The soils in proposed absorption area and designated reserve area shall be stabilized prior to conducting percolation and deep-hole tests to determine compliance with all boundary conditions. Appropriate ditches, berms, and drains (curtain, vertical, under drains) shall be installed to control surface drainage and ground water in the vicinity of absorption fields on sloped sites. Site modification activities to reduce slope to 15% or less should only be conducted during relatively dry periods to minimize soil compaction and smearing.

9.6.4.1 In-situ Absorption Trenches on Sloped Sites

Many LHDs have experienced satisfactory absorption facility performance from very carefully constructed absorption trenches installed in in-situ soil with slopes of > 15% to 20% when special conditions are met. The slope limitation is primarily established for construction safety; it is difficult to operate equipment and steeper slopes pose a construction hazard. From a hydraulic perspective, trench-type systems can be positioned on steeper slopes. The installation of absorption trenches on sloped sites is recommended (instead of site modification, such as cut or fill, to reduce site slopes) because in-situ installation of absorption trenches will maintain soil structure and minimize site disturbance, compaction and erosion. Trenches can be installed when acceptable soil conditions exist and trench separation as follows is used:

- (1) The in-situ soil must have a percolation rate of one (1) to sixty (60) minutes per inch.
- (2) Absorption trench design (length) is in accord with **Table 6A, 6B, 6C or 6D**.
- (3) Absorption trenches shall be constructed parallel to contours and extend up to 60 feet (a drop box can be used to maximize trench lengths along contours by extending trenches a maximum of 60 feet in either direction from the drop box to maximize downgradient soil treatment area of receiving soils).
- (4) A minimum horizontal separation distance between parallel absorption trenches of 10', 9', 8', or 7' is provided when the minimum vertical separation distance from the bottom of any absorption trench to high ground water, bedrock, or impermeable soil is 2', 3', 4' or 5', respectively:

SLOPE (%)	Vertical Separation to boundary Condition (feet)	Horizontal Separation between Trenches (feet)
0 - 15	2	4
15 - 20	2	10
	3	9
	4	8
	5	7

- (5) Required separation distances from wastewater system components in **Table 2** are provided.

9.7 Specific Waivers or Other Local Approvals

New construction is required to routinely meet standards established in either Appendix 75-A or when more stringent local standards exist. Specific waivers (or other local approvals), however, may be granted by the LHD (or other agency or local authority having jurisdiction) for new construction of system designs and engineering concepts not listed in Appendix 75-A as well as for deviations from standard(s) established in Appendix 75-A. (In some cases, a general waiver or local waiver may previously have been granted for said design or deviation and a specific waiver would not be needed). Specific waivers (or other local approvals) are not required for replacement systems unless the LHD (or other agency or local authority such as a watershed) has a replacement system approval program. LHDs grant specific waivers/local approvals at their discretion on a case-by-case basis.

A specific waiver is intended to provide administrative flexibility for the LHD and is not intended as a device for routinely approving residential OWTSs that do not meet design standards. When another agency or local authority has jurisdiction and/or a more stringent local standard exists, any approvals of deviations from the standards can only be granted by the applicable agency or local authority.

Specific waivers or other local approvals may be granted for site-specific situations because of a “hardship or other circumstance” that makes it impractical to comply with a standard. An example of a “hardship” includes a building lot that had been previously approved according to the requirements of a previous version of Appendix 75-A (or local standard) that then becomes non-compliant due to updated and more restrictive standards. “Other circumstances” refers to cases specifically mentioned in Appendix 75-A, discussed in this Handbook or other Department policy. Anticipating that a “created” hardship (such as tearing down a house known to have an existing substandard OWTS) will be eligible for a specific waiver without contacting the local health department or other local authority having jurisdiction first is at the homeowner’s risk and a specific waiver or other approval could be denied.

A specific waiver application must show that the proposed deviation from an Appendix 75-A requirement(s) will provide a degree of protection equivalent to the intent of Appendix 75-A and will not result in an increased risk to public health or the environment.

The LHD (or other agency or local authority having jurisdiction) needs to be contacted before a request for a specific waiver or other local approval is considered. Specific waiver application forms are included in **Appendix E**, or can be obtained from the local health department or the NYSDOH website: <http://www.health.ny.gov/environmental/water/drinking/forms/forms.htm>

9.8 Materials Used in Onsite Wastewater Treatment Systems

Non-perforated rigid watertight pipe shall be used from the septic tank or ETU to the distribution box or drop box, from the distribution box to the head of the absorption trenches and between successive drop boxes. The pipe shall be resistant to deformation or crushing, typically Schedule 40 or SDR 35 PVC pipe is used. Watertight pipe at least two (2) feet in length should be between distribution box and absorption area distribution lines. Perforated distributor pipe shall only be used in the absorption area. Four (4) inch diameter pipe is recommended for all gravity distribution systems. Perforated pipe shall be made of rigid or corrugated plastic and be labeled as fully meeting ASTM standards for septic systems. Perforated pipe shall have an ASTM stamp for leachfield pipe, see ASTM F481 - 97(2008), “Standard Practice for Installation of Thermoplastic Pipe and Corrugated Pipe in Septic Tank Leach Fields”. Corrugated plastic pipe delivered in coils is not to be used unless provision is made to prevent the recoiling or movement of the pipe after installation.

Pressure distribution pipe shall have a minimum diameter of one (1) inch and a maximum diameter of three (3) inches. Pressure distribution lines and dosing distributors should be installed level. Pipe for siphon dosing is sized to conform to the volume of the dose and can range from three (3) to six (6) inches in diameter based upon the volume of each dose. In gravity distribution systems, distributor pipe should be laid at a slope between 1/16 inch and 1/32 inch per foot.

A typical gravity distribution absorption trench detail is shown in **Figure 17**. The ends of distributor pipes in gravity distribution systems should not be interconnected since it reduces operational flexibility of resting individual lines as needed and may result in unequal distribution of effluent to individual trenches (the lower trench will receive more effluent than the higher trench).

Aggregate used in absorption fields is typically natural stone, washed gravel or washed crushed stone 3/4 to 1-1/2 inches in diameter. Larger diameter or finer substances (e.g., crushed shells) are unacceptable. DOT # 2 stone is often used as absorption area aggregate because of availability even though the gradation does not always meet the above specifications. It is very important to verify the stone is thoroughly washed to remove fines (stone dust) which can clog the infiltrative surface area in an absorption trench or bed.

9.8.1 Alternate Aggregate

Alternate aggregate materials may be used as a substitute for conventional gravel or stone aggregate when it can be demonstrated that the material provides at least the equivalent soil infiltration area and storage volume as conventional gravel or stone aggregate. Materials shall also maintain structural integrity and be non-degradable by wastewater effluent.

9.8.2 Tire Derived Aggregate (TDA)

Properly manufactured TDA has physical characteristics similar to conventional gravel or stone aggregate and may be used as a substitute for gravel or stone aggregate on a one-to-one (1:1) basis, volumetrically when:

- (1) The TDA manufacturer shall have a written case specific beneficial use determination from the New York State Department of Environmental Conservation (NYSDEC) for use in onsite wastewater treatment systems, and
- (2) TDA shall meet the following size and gradation requirements:
 - (i) Two (2) inch nominal size, and
 - (ii) Maximum dimension in any direction shall not exceed four inches and the minimum dimension in any direction shall not be less than 1/2 inch, and
 - (iii) Exposed wire shall not be protrude more than 1/2 inch from the chip, and
 - (iv) Fine particles and foreign materials are prohibited, and
 - (v) At least 95% of the TDA shall comply with the above specifications.

Go to the University of Buffalo Website for more information on TDA:

<http://www.tdanys.buffalo.edu/UB/>

9.9 Conventional Absorption Trench Systems

9.9.1 General Information

A conventional absorption trench system is a system of narrow trenches partially filled with aggregate in which a distribution pipe is laid. Two (2) types of absorption trench field layouts are in common use: (a) a distribution box connected to parallel absorption laterals for flat or minimally sloped sites and (b) a drop box connected to parallel successive trenches along a slope on sites with 10% or greater slopes.

9.9.2 Site Requirements

The minimum distances that absorption fields shall be separated from other facilities are shown in **Table 2** and **Figure 1**. A minimum of four (4) feet of useable soil shall exist above bedrock, impermeable strata, and groundwater with a minimum separation of two (2) feet to the lowest part of any trench. Absorption fields shall not be built under driveways, parts of buildings, under aboveground swimming pools or other areas subject to heavy loading. Surface waters shall be diverted from the vicinity of the system. All proposed sites shall be evaluated in terms of slope, wetlands, watercourses, rock outcroppings, soil characterization, subsurface boundary conditions, soil percolation, and location of wells in the vicinity and property boundaries.

9.9.3 Design Criteria

The required length of absorption trench is dependent upon the daily design flow rate and soil percolation test results. The total absorption trench length is determined using **Table 6A** for various standard residential daily design flow rates or **Table 6B** for non-standard residential daily design flow rates. The maximum length of absorption lines used in conjunction with gravity distribution shall be 60 feet. The maximum length of absorption lines used in conjunction with pressure distribution or dosing shall be 100 feet. All absorption lines in a system shall be approximately the same length. If unequal trench lengths are necessary because of site obstacles such as a large tree or other site feature that cannot be removed, it is recommended to utilize a drop box when enough slope exists to implement progressive trench distribution and control distribution to absorption trenches.

Absorption trenches should not be installed when soil is wet to prevent undesirable smearing and compaction of the infiltrative soil surface. Trenches shall be installed parallel to ground contours and as shallow as possible. Trenches need not be perfectly straight but abrupt changes in direction should be avoided. Maintaining a uniform slope for the entire length of each perforated distributor line is very difficult when the lines are not installed straight. The sides and bottom of trenches shall be raked prior to placement of aggregate to open soil pores. The ends of all distributor pipes shall be capped.

Wastewater treatment efficiency is related to the area of the trench bottom and sidewall (known as the wetted perimeter) available for infiltration. The typical gravity absorption trench detail is depicted in **Figure 17**. At least six (6) inches of aggregate is placed under the distribution line and then the line is covered by a minimum of two (2) inches of aggregate. The slope of the perforated distribution lines shall be 1/16 to 1/32 inch per foot. The aggregate shall be covered with a material that prevents backfill soil from entering the aggregate and permit air and moisture to pass through. The preferred material for covering the aggregate is a permeable non-woven geotextile. A permeable non-woven geotextile is extremely strong and does not promptly degrade like untreated building paper, hay or straw. Untreated building paper or a four (4) inch layer of hay or straw is also acceptable for covering aggregate when proper geotextiles are unavailable. Polyethylene and treated building paper are

relatively impervious and shall not be used. Earth cover above the aggregate shall be between six (6) and twelve (12) inches to enhance natural aeration and nitrate uptake by plant life. Trench bottom depth should be as shallow as possible but not less than 18 inches or more than 30 inches below ground surface. The maximum trench width for design purposes shall be 24 inches and the required length of absorption trench for standard residential daily design flow rates and soil percolation rates for a 24 inches wide trench are listed in **Table 6A** or can be calculated from **Table 6B**. Where trenches exceed 24 inches in width, calculations of absorptive area shall be based on a width of 24 inches.

Adjacent absorption trenches shall be separated by at least four (4) feet of undisturbed soil as depicted in **Figure 18**. Individual trenches shall be constructed parallel to ground contours with the trench bottom essentially level.

9.9.4 Construction

Construction of absorption facilities shall not occur when the ground is frozen or the soil moisture content is high. If a fragment of soil from approximately nine (9) inches below the surface can easily be rolled into a ribbon instead of crumbling, the soil moisture content is too high for construction purposes. Obviously, some silt or clay must be present for a ribbon to be formed.

The natural surface shall not be significantly disturbed. If the site is regraded or similarly disturbed, the soil shall be allowed to stabilize (i.e., settle naturally for a period of at least six (6) months, including at least one freeze-thaw cycle) and new percolation and deep hole tests conducted after the stabilization period. Heavy equipment use in the designated absorption system area should be minimized to prevent soil permeability reduction due to compaction.

Trench locations and depths should be marked by stakes and the grade checked before trench excavation. Trenches shall be excavated to design depth (i.e., 18 to 30 inches below grade and at least two (2) feet above boundary condition) with bottoms practically level.

Following excavation, the trench bottoms should be graded by hand. The bottoms of the trenches should be checked by a transit, engineer's level, or carpenter's level to assure that each is practically level. Trench bottoms and sidewalls should be immediately raked after final grading to ensure infiltration surface soil pores are open and not smeared or compacted. At least six (6) inches of aggregate is placed in the trenches as gently as possible to avoid compaction.

Gravity distributor pipe shall be carefully installed at a slope of 1/16 to 1/32 inch per foot. Pressure or dosed distributor pipe shall be installed level. Aggregate shall be installed in the trenches to a depth of at least two (2) inches above the top of the distributor pipes. Additional aggregate may be required to bring the top of the aggregate to within six (6) to twelve (12) inches of final grade as shown in **Figure 17**.

After the upper aggregate is placed in the trenches the geotextile, untreated building paper, hay or straw is to be immediately installed on the aggregate and the trench backfilled with excavated soil. If trenches cannot be immediately backfilled, the trenches should be temporarily covered with an impervious material, such as treated building paper to prevent siltation into the aggregate.

The earth backfill is mounded (but not compacted) slightly above the original ground level to allow for settling. Following settlement, the entire area should be graded without the use of heavy equipment that could cause compaction, trench cave-in or distributor pipe misalignment or breakage. Heavy equipment shall not enter the absorption facility area or the proposed expansion area after the system has been constructed. The entire area must be seeded with grass as soon as possible. Establishing a grass cover stabilizes the soil, sheds and absorbs rainwater, provides some nutrient uptake and insulates the absorption area. If grass cannot be established prior to winter, the area needs to be covered

and insulated with straw or mulch to prevent freezing and minimize erosion. Trees and shrubs should not be planted or allowed to grow to prevent root interference.

9.10 Gravelless Absorption Trench Systems

9.10.1 General Information

Gravelless absorption trench systems are generally proprietary products that allow effluent to infiltrate soil without the use of aggregate. These products are often installed where aggregate is not available, because of ease of installation or to increase the soil infiltrative surface area available in trench areas. Aggregate in trenches or beds keeps excavations open, creates voids for air exchange and allows wastewater infiltration into the soil around aggregate voids. Aggregate effectively creates voids for wastewater treatment and dispersion but can also create a degree of soil masking and takes up void space in a trench or bed.

Many types of gravelless absorption products are available such as; plastic open-bottom chambers, large diameter geotextile wrapped corrugated pipe and geotextile wrapped plastic cusped core pads. Some products incorporate surrounding them with concrete sand. Chambers can provide increased soil infiltration area for trench bottoms and sand surrounded systems enhance aeration and filtration. These systems must be installed in accordance with the manufacturer's recommendations. All gravelless products must also be capable of withstanding typical construction equipment and residential use loads without deformation.

9.10.2 Site Requirements

Gravelless products may be used in place of conventional aggregate filled absorption trenches on any site conditions or designs where conventional aggregate filled absorption trenches are acceptable. All other treatment system design requirements shall apply.

9.10.3 Design Criteria

Unless otherwise specified for some products described below, all absorption trench system designs incorporating gravelless products shall have the same trench length as a conventional (24-inch wide) absorption trench as listed in **Table 6A** or as calculated from **Table 6B**. **Appendix C** includes a list of "accepted" gravelless products. This list will be updated periodically, therefore, the LHD having jurisdiction should be contacted prior to design or construction regarding the acceptability of specific products.

NOTE: The NYSDOH does not officially approve proprietary products; however, products may be reviewed to determine their compliance with Appendix 75-A. The use of proprietary products is also subject to the conditions and requirements of local health departments, other agencies or other local jurisdictions. Local design standards may be more stringent than Appendix 75-A.

9.10.3.1 Open-Bottom Gravelless Chambers

Figure 20 depicts a typical open-bottom gravelless chamber. These chambers are engineered and often made of recycled plastic. Some are sized to provide a minimum soil infiltration bottom area of 1.6 square feet per linear foot, a minimum volumetric capacity of 7.5 gallons per linear foot and open sidewall area for aeration and infiltration. Products that meet these criteria maintain a soil surface available for infiltration typically twice as large as an aggregate filled trench. These products are allowed to use a 25% reduction in the total absorption trench length when adequately sized chambers are utilized. **Table 6C** shows adjusted trench lengths for standard residential daily design flows. For non-standard daily design flows use a 25% reduction in total trench as calculated using **Table 6B**. Smaller chambers can replace aggregate filled trenches on a 1:1 trench length basis.

9.10.3.2 Media-Wrapped Corrugated Pipe Sand-Lined Systems

These systems, as depicted in **Figure 22**, provide improved wastewater treatment and filtration through layers of filtering media surrounding the pipe and increase aeration and surface area from encasing in specified sand and passive venting. These products are allowed to use a 25% reduction in the total absorption trench length when the following features are provided: corrugated pipe with a minimum outside diameter of twelve (12) inches, wrapped in a media that allows wastewater distribution and prohibits sand infiltration, and is installed with a minimum of six (6) inches of washed concrete sand surrounding the pipe. **Table 6C** shows trench lengths for standard residential daily design flows, for non-standard flows use a 25% reduction in total trench as calculated using **Table 6B**.

9.10.3.3 Gravelless Geotextile Sand Filter Systems

This type of product, as depicted in **Figure 21**, is allowed a bottom sizing criteria of 6-square feet per linear foot of trench and has product features of: a width of three (3) feet, a minimum storage capacity of twelve (12) gallons per linear foot of the unit, a minimum of six (6) square feet per linear foot of geotextile surface area per linear foot of the unit, and is installed with six (6) inches of washed concrete sand below and on the sides of each unit. These product features allow for improved wastewater treatment and filtration. **Table 6D** shows trench lengths for standard residential daily flows, for non-standard flows use six (6) square feet per linear foot instead of two (2) square feet per linear foot for calculating the total trench length using **Table 6B**.

The trench length sizing and reduction discussed above may be used for conventional, including shallow absorption, trench systems (including at least two (2) feet of useable soil exists above boundary conditions).

The gravelless trench length reductions may not be further reduced by the trench length reduction allowed for Enhanced Treatment Units (ETUs).

9.10.4 Construction

Gravelless absorption system products shall be installed in conformance with the manufacturer's instructions because of the proprietary design of some products. The gravelless trench sidewalls shall be separated by a minimum of four (4) feet of undisturbed soil.

9.11 Deep Absorption Trenches

9.11.1 General Information

Deep absorption trenches may be used where sites contain at least four (4) feet of useable soil overlain by one (1) to five (5) feet of very slow percolating soil (greater than 60 minutes per inch). Conventional absorption field systems may be used when the overlying impermeable soil is no more than one (1) foot deep provided backfill above the aggregate is comprised of only permeable soil. A “cut and fill” system may also be used in most cases where a deep trench system may be used. The cut and fill system (remove and replace poor soils) is the recommended choice because shallow trenches and permeable soil provide an improved treatment environment through better oxygen exchange and increased infiltrative soil surface area (aggregate to permeable soil interface).

As shown in **Figure 23**, trenches are excavated at least two (2) feet into the permeable soil. Careful excavation is necessary to assure that impermeable overburden does not remain in the trench bottom. The trenches shall be backfilled to within 30 inches or less of the surface with aggregate or coarse sand to promote aeration and utilization of the entire infiltrative permeable soil surface (permeable soil - sand/aggregate interface). A conventional absorption field system (trenches with distribution lines and aggregate) is constructed in the upper 30 inches of the deep trenches. The inverts of distribution lines shall not be deeper than 24 inches below grade. Diversion of surface runoff around the absorption area by means of ditches or berms is required uphill of all sloped sites. Venting of the system from bottom of trenches to the surface to provide means for aeration of deep trench area is recommended to enhance treatment capability.

9.11.2 Site Requirements

These systems are used on sites where a useable layer of soil [i.e., at least four (4) feet deep] is overlaid by one (1) to five (5) feet of impermeable soil and the slope does not exceed 15%. In addition, the vertical and horizontal separation distances noted in **Figure 1**, **Figure 23** and **Table 2** shall be met.

9.11.3 Design Criteria

At least four (4) feet of useable soil above ground water, bedrock or impermeable strata shall be present below the one (1) to five (5) feet of impermeable soil. The required length of absorption trench shall be determined from **Table 6A** or calculated from **Table 6B** based upon the daily design flow rate and percolation test results of the underlying permeable soil.

9.11.4 Construction

Trenches are excavated at least two (2) feet into the useable soil and backfilled with aggregate or coarse sand to within 30 inches or less of the surface. The trenches shall be constructed parallel to surface contours and the trench bottoms shall be as level as possible. A conventional absorption field system shall be constructed in the upper 30 inches of the trenches. On sloped sites, a diversion ditch or berm shall be constructed on the uphill side of the absorption area to prevent surface runoff from entering the trenches. The soil placed above the aggregate in the trenches shall have a percolation rate faster than 60 minutes per inch. Original surface material (the overlying impermeable soil) shall not be used as backfill above the aggregate in the trenches.

9.12 Shallow Absorption Trenches

9.12.1 General Information

Shallow absorption trenches are constructed parallel to ground contours with the bottom of the trenches as level as possible and located within original ground surface level. These systems may be used where sites contain at least two (2) feet but less than four (4) feet of useable soil. Diversion of surface runoff around the fill area by means of ditching or berming is required uphill of all sloped sites. Heavy equipment shall not enter the absorption area. Fill material shall have approximately the same percolation rate as the underlying permeable soil. Fill material, including a six (6) inch topsoil layer, shall not be more than 30 inches above original grade. Fill material shall extend at least six (6) feet horizontally from and at the same depth as the trench sidewall and will have a one (1) vertical to three (3) horizontal taper at the edge to intersect with the original ground surface. Carefully dug spoils from the house foundation can be used if similar soil characteristics exist and proper soil stabilization methods are used. A conventional absorption trench system is constructed in the fill and original soil as shown in **Figure 24**. Preference is for the trench bottom to extend into the in-situ soils to promote vertical distribution to soils and minimize preferential drainage pathway at the in-situ soil-fill material interface. To avoid short-circuiting of wastewater to the surface fill more permeable than the onsite permeable soil shall not be utilized.

9.12.2 Site Requirements

These systems are used where there is at least two (2) feet but less than four (4) feet of useable soil. Vertical separation distances between trench bottoms and boundary conditions (bedrock, ground water, and impermeable strata), as depicted in **Figure 24**, shall be met. The horizontal separation distances noted in **Figure 1 and Table 2** shall also be met.

Separation exception for shallow trench systems: Generally or all systems involving the placement of fill material, separation distances are measured from the toe of slope of the fill; however, when the trench bottom is at least six (6) inches into existing soil, the separation distance is measured from the trench sidewall(s).

9.12.3 Design Criteria

A minimum two (2) feet separation must be maintained between the bottom of each trench and all boundary conditions (bedrock, ground water, and impermeable strata). The bottom of each trench must not be above the original ground surface and should preferably be at least six (6) inches below original grade. At least two (2) percolation tests shall be performed within the proposed absorption area with the bottom of the test holes at the depth of the proposed trenches or at six (6) inches below grade if the bottom of the proposed trenches will be between grade and six (6) inches below grade. The slowest percolation rate observed shall be used to design the absorption facility. Fill material shall have a permeability similar to but not more permeable than the underlying in-situ useable soil. The depth of fill material, including the topsoil layer, shall not exceed 30 inches above the original ground elevation. A conventional absorption trench system as depicted in **Figure 17 and Figure 24** is designed and constructed in the fill and into original soil. The required length of absorption trench shall be determined from **Table 6A or Table 6B** based upon the daily design flow rate and percolation test results of the in-situ permeable soil. Percolation test results of the fill material (foundation spoils or borrow pit soils) shall be used to assure that the permeability of the fill material is compatible with the in-situ soil permeability.

9.12.4 Construction

Generally, sites with large trees, numerous small trees or large boulders are unsuitable for a shallow absorption trench system because of the difficulty in preparing the site and the reduced infiltration area beneath the system. In areas, which are suitable, all trees and stumps shall be cut at grade and removed. Other vegetation (brush, vines, weeds, grass) shall be cut as close to grade as possible and removed. All leaves, limbs and boulders above grade shall also be removed. Root structure below grade should not be removed. Plowing the area where fill is to be placed “folds” soil over without destroying the soil structure and infiltration capability of the receiving soils. Rototilling or soil scarification should never be performed in the fill area by heavy construction equipment because of the probability of destroying the soil structure, compacting soils and reducing the infiltration capability.

Heavy equipment shall be kept out of the absorption area. Grade stakes may be used to delineate the limits of fill and prevent over-excavation of absorption trenches. Fill material shall be carefully placed within the absorption area. The edge of the fill material shall be extended at least six (6) feet beyond the perimeter of the proposed trenches and then tapered at a slope no greater than one (1) vertical to three (3) horizontal. On sloped sites, a diversion ditch or berm shall be constructed on the uphill side of the fill material to prevent surface runoff from entering the fill. Construction of trenches at least six (6) inches into existing in situ soil is preferred to utilize a stabilized sidewall infiltrative surface.

9.13 Cut and Fill Systems

9.13.1 General Information

A cut and fill system, as depicted in **Figure 25**, is an absorption trench system installed on sites where impermeable soil overlays useable soil. These systems are generally used where the impermeable overlying soil is one (1) to five (5) feet deep. Conventional absorption field systems may be used when the overlying impermeable soil is no more than one (1) foot deep and useable soil is placed above the aggregate. For cut and fill system, unlike deep absorption trench systems, the overlying impermeable soil is removed from the proposed absorption field area that extends at least five (5) feet beyond any proposed absorption trenches and replaced by permeable soil comparable to the underlying soil. Careful excavation is necessary to assure that the useable underlying soil is not made unuseable through compaction and impermeable overburden does not remain in the bottom of the excavation on top of the permeable underlying soil. A conventional absorption trench system is constructed in the upper 18 to 30 inches of the permeable fill and underlying soil. If the bottom of all trenches is not in or at the permeable underlying soil (meaning the trench bottoms are in fill), the fill must undergo proper stabilization and percolation testing prior to constructing the trenches. Stabilization may be achieved by natural settlement for at least six (6) months including at least one (1) freeze-thaw cycle. If the underlying permeable soil and the comparable permeable fill comprise only granular material (sand and sandy loam), stabilization may be achieved by mechanical compaction in six (6) inch lifts to the approximate density of the undisturbed underlying granular soil. On sloped sites, a diversion ditch or berm shall be constructed on the uphill side of the fill area to prevent entrance of surface runoff.

Although deep trench systems may be used at sites with four (4) feet of useable soil overlaid by one (1) to five (5) feet of impermeable soil, a cut and fill system is the recommended choice because shallow trenches and permeable fill material provide an improved treatment environment through better oxygen exchange and increased infiltrative soil surface area (aggregate to permeable soil interface).

9.13.2 Site Requirements

These systems may be used where all the following conditions exist:

- (1) Soil with a percolation rate slower than sixty (60) minutes per inch overlays a useable soil with a percolation rate of one (1) to sixty (60) minutes per inch.
- (2) At least three (3) feet of useable soil is present beneath the overlaying impermeable soil.
- (3) All minimum vertical and horizontal separation distances from the absorption trenches noted in **Figures 1, Figure 25 and Table 2** are met.

9.13.3 Design Criteria

The overlaying impermeable soil shall be removed and replaced with a soil having a percolation rate comparable with the underlying useable soil. The excavation method selected should assure that the useable underlying soil is not made un-useable through compaction. A conventional absorption trench system as depicted in **Figures 17 and 25** is designed for the upper 18 to 30 inches of the permeable fill and underlying soil. The required length of absorption trench shall be determined from **Tables 6A or 6B** based upon the daily design flow rate and percolation test results of the permeable fill or underlying soil (whichever has the lower permeability). Stabilization of the fill is required prior to conducting percolation tests and constructing trenches if the bottoms of all trenches are not in or at the underlying useable soil. Percolation test results of the fill material performed at the borrow pit shall be used to assure that the permeability of the fill material is compatible with the on-site soil permeability.

9.13.4 Construction

The area excavated and filled must provide at least a five (5) foot buffer in each direction beyond the trenches. The soil placed above the trenches shall have a percolation rate faster than sixty (60) minutes per inch. Original surface material (the overlaying impermeable soil) shall not be used as backfill above the trenches. The surface area of the fill system must be mounded and graded to enhance runoff of precipitation from the absorption system and seeded to grass. On sloped sites, a diversion ditch or berm shall be constructed on the uphill side of the absorption area to prevent surface runoff from entering the fill.

9.14 Absorption Bed Systems

9.14.1 General Information

An absorption bed system, as depicted in **Figure 18** and **Figure 26**, operates on a principle similar to the absorption trench except that several distribution laterals, rather than just one, are installed in a single excavation and surrounded with aggregate. This, however, reduces the effective sidewall infiltration area per lineal foot of lateral. These systems require the use of pressure distribution or siphon dosing (when slope permits) and are limited to sites with a maximum slope of 8% and at least four (4) feet of useable soil with a percolation rate of one (1) to thirty (30) minutes per inch. Careful excavation is necessary to assure that the bottom and sidewall areas are not made unuseable through compaction. Heavy construction equipment shall be kept outside the proposed bottom area of the absorption bed. Diversion of surface runoff around the absorption bed area by means of ditches or berms is required uphill on all sloped sites. Bed width on sloped sites should be minimized to maximize wastewater distribution parallel to the slope and to prevent ends of the bed from being too deep or too shallow.

9.14.2 Site Requirements

An absorption bed system may only be built in soils with a percolation rate between one (1) and thirty (30) minutes per inch. A bed shall not be built where the soil evaluation indicates silty loam, clay loam, or clay. Slope of the site shall not exceed 8%. The length of the bed shall be as parallel as possible with the ground contours. Bed systems are more practical on sites that are long (parallel to ground contours), narrow and with a minimal slope. All minimum vertical and horizontal separation distances noted in **Figure 1**, **Figure 18**, **Figure 26** and **Table 2** shall be met. Useable soil at the absorption bed site must be at least four (4) feet deep.

9.14.3 Design Criteria

Pressure distribution is required for the installation of an absorption bed system. The LHD or other agency having jurisdiction may allow the use of siphon or pump dosing on specific sites. The maximum width of the absorption bed shall be 20 feet. The maximum length of each lateral for a pressure manifold shall be 100 feet and for a siphon or pump dosing system shall be 75 feet. Use of a center manifold system enables the distributor lengths to be doubled. Distribution boxes are not to be used with a pressure distribution system.

The depth of the absorption bed shall be between 18 and 30 inches below original ground level (as measured at the midpoint of the width of the bed). Distribution laterals shall be spaced a maximum of five (5) feet center to center. There shall be at least 2.5 feet between the perimeter distribution laterals and the bed sidewalls as depicted in **Figures 18** and **26**.

The maximum absorption bed size is 20 feet wide by 205 feet long for pressure distribution with a center manifold and 155 feet long for pump or siphon dosing with a center manifold. The maximum bed size is 20 feet wide by 105 feet long for pressure distribution with an end manifold and 80 feet long for pump or siphon dosing with an end manifold.

Pressure distribution lines should be one (1) inch to three (3) inches in diameter with all downstream ends capped or looped. The volume discharged during each cycle of a pressure distribution system will exceed the volume available in the pipe distribution network and will be discharged from the pipe under pressure. Pumps for the pressure distribution system should be designed to provide one (1)

pound per square inch (2.3 feet of head) at the downstream end of the distribution laterals during bed dosing. Smaller more frequent doses (e.g., 6 to 12 times over a 24 hour period) using a timed dosing method is recommended to allow for rest periods between doses.

Pipe for siphon dosing is sized to conform to the volume of the dose and can range from three (3) to six (6) inches in diameter based upon the volume of each dose. The downstream ends of all distributor laterals shall be capped. The volume discharged during each cycle of a pump or siphon dosing system should be 75% to 85% of the volume available in the pipe distribution network or three (3) to five (5) times per day based upon daily design flow volumes, whichever is smaller.

The required bed bottom areas for standard daily design flows are listed in **Table 7A** or can be calculated for non-standard daily design flows using the application rates listed in **Table 7B**.

Gravelless absorption trench products may be used in absorption bed applications in accordance with the manufacturer's recommendation; however, the bottom areas listed in **Table 7A** or as calculated from **Table 7B** must remain the same.

9.14.4 Construction

The location of the proposed absorption bed should be marked with stakes before construction begins. Heavy construction equipment shall be kept outside the proposed bottom area of the bed to avoid compaction of the soil. The required absorption bed bottom area is excavated to the design depth as level as practical. The bottom and sidewalls of the bed shall be hand raked to prepare the soil infiltrative surface. Bottom levelness shall be checked with a transit, laser level or carpenter's level. The level absorption bed shall be covered with a six (6) inch layer of aggregate (3/4 to 1-1/2 inch washed gravel or crushed stone). The distribution laterals need to be installed level upon the six (6) inch layer of aggregate. Additional aggregate shall be installed across the entire bed to two (2) inches above the top of the distribution laterals.

The entire bed area of aggregate shall be covered with a permeable non-woven geotextile to permit movement of fluids and repel movement of backfill soil into the aggregate. Untreated building paper or a four (4) inch layer of hay or straw may be substituted if a permeable non-woven geotextile is unavailable. The geotextile shall be covered with permeable soil backfill mounded slightly above original grade and seeded with grass. If settlement occurs over time (at least (6) six months including at least one freeze-thaw cycle), the area should be re-graded by hand to enhance surface drainage away from the absorption bed.

9.15 Seepage Pits

9.15.1 General Information

Due to the reduced treatment capability of seepage pits, if soil and site conditions are adequate for absorption trenches, seepage pits shall not be used. All of the other conventional absorption systems are recommended over seepage pits.

A seepage pit, as depicted in **Figure 27**, is a covered pit with an open-jointed or perforated lining through which septic tank effluent infiltrates into the surrounding soil. These devices are sometimes called a leaching pit or leaching pool and incorrectly called a cesspool. If soil and site conditions are adequate for absorption trenches, seepage pits shall not be used because absorption trench systems provide better distribution of effluent to the infiltrative soil surface, enhanced natural aeration of the infiltrative surface and reduced probability of ground water contamination. Seepage pits may only be

used where the available land is insufficient for construction of absorption trench systems or where relatively impermeable shallow surface soils overlay deep useable soils. Cut and fill systems and deep trench systems are recommended, however, over seepage pits because of improved infiltrative soil surface area and natural aeration.

Due to the reduced treatment capacity of seepage pits, the bottom of seepage pits must be at least three (3) feet above ground water, bedrock or impermeable strata. Large aggregate sized 3/4 to 2-1/2 inches is used on the bottom of the pit and as an annular ring surrounding the pit liner. Larger sized aggregate (more than 2-1/2 inches) is not recommended because it results in increased soil infiltrative surface masking (meaning settled sewage cannot flow through the aggregate particles into the soil) and increased settlement of soil outside the annular ring from soil movement into the larger aggregate voids.

A distribution box shall be used to convey effluent to more than one seepage pit. Seepage pits shall not be connected in series. When multiple pits are used, all should be approximately the same size. Each pit should receive approximately the same flow of effluent. On sloped sites, a diversion ditch or berm should be constructed uphill from the pit(s) to prevent surface runoff from entering the pit(s). Series of pits should be installed parallel rather than perpendicular to ground contour lines to minimize ground water mounding. Use of shallow pits is recommended in place of deep pits to enhance natural aeration of the soil infiltrative surface.

9.15.2 Site Requirements

If soil and site conditions are adequate for absorption trenches, seepage pits shall not be used. All other conventional absorption systems are recommended over seepage pits. A minimum three (3) foot vertical separation must exist between the bottom of any pit and the high ground water level, bedrock or impervious strata as depicted in **Figure 27**. Sufficient area must be available to provide three (3) times the effective diameter between pits (this includes the undisturbed soil between pit excavations) and all required horizontal separation distances from any pit as shown in **Figure 2** and **Table 2** shall be met.

9.15.3 Design Criteria

The required number and size of seepage pits for a given household shall be determined from **Tables 8A and 8B** based upon the daily design flow rate and percolation test results of the on-site permeable soil. Pits should be as shallow as possible to enhance natural aeration of the soil infiltrative surface. Pit depth is frequently controlled by the depth to ground water, bedrock, and impermeable strata. If relatively uniform soil is encountered, two (2) percolation tests should be made for each pit: one (1) at the halfway depth and the other at the bottom of the pit. The results are averaged to obtain the applicable percolation rate. If different soil layers are encountered at the proposed pit sidewall area, a percolation test shall be conducted in each permeable layer and the applicable pit design percolation rate shall comprise the weighted average of each test result based upon the depth of each permeable layer. The required "effective seepage pit sidewall area" can be determined from **Tables 8A and 8B** based upon the daily design flow rate and the "applicable percolation rate". The applicable percolation rate should only be used where the impervious soil layers (percolation rate slower than sixty (60) minutes/inch) comprise small lenses rather than extensive/broad layers. The three (3) foot vertical separation of the pit bottom above impermeable strata should apply to the entire effective sidewall area of a pit.

No allowance for infiltration area shall be made for the bottom area of a pit or the sidewall surface area of impervious soil layers (percolation rate slower than sixty (60) minutes/inch). The preferred soil percolation rates for seepage pits range from five (5) to sixty (60) minutes per inch. The required effective seepage pit sidewall infiltrative area is shown in **Table 8A** for various daily design flows and sidewall percolation rates. **Table 8B** shows the effective sidewall absorption area for various sized cylindrical seepage pits.

The effective diameter of a pit is the diameter of the large aggregate-infiltrative soil surface cylinder (i.e., the diameter of lining plus the annular ring of large aggregate) as shown in **Figure 27**. The effective depth of a pit is the vertical distance from the invert of the inlet to the bottom of the pit with the thickness of any intervening impervious layers deducted. The required effective seepage pit area for a given household can be obtained by varying:

- 1) The number of seepage pits,
- 2) The shape (usually cylindrical) of the pit, and
- 3) Seepage pit dimension (effective depth, diameter, length, width, etc.).

Perforated or open-jointed linings may be precast concrete, cast-in place concrete or constructed in place with unmortared hollow cinder or concrete blocks. Concrete shall have a minimum compressive strength of 2,500 psi and 3,000 psi is recommended. Material with comparable structural strength, determined in accordance with commonly accepted wastewater facility construction standards, principles or practices, may be allowed on an individual basis to prevent unreasonable hardship, provided public health is not prejudiced.

Precast rings with large perforations all around are widely used for seepage pits due to their structural soundness, durability, and low cost of installation. Often advertised as "dry wells", these precast rings are usually available in various diameters with approximately two (2) to four (4) foot heights. The sections are manufactured with ship lap joints to facilitate stacking. Footing rings are also readily available when needed.

If standard building block is used to construct the lining, eight (8) inch block should be used with the cells horizontal and facing the nearest pit sidewall. Pits shall be designed with sufficient structural stability to withstand lateral soil forces as well as vertical loads.

Laterals conveying effluent to seepage pits shall be non-perforated and watertight, at least four (4) inches in diameter, and installed with a minimum slope of 1/8 inch per foot. Seepage pits shall not be connected in series. A distribution box shall be used to convey settled sewage to more than one seepage pit.

The separation distance between the outside edges of seepage pits shall be at least three (3) times the effective diameter of the largest pit. This separation distance is measured across the undisturbed soil between pit excavations.

When multiple pits are used, each pit shall have an equal effective sidewall absorption area to facilitate equalization of flow to the total infiltrative surface area. The distribution box shall provide equal flow to each pit. On sloped sites, a diversion ditch or berm should be constructed uphill from the pit(s) to prevent surface runoff from entering the pit(s).

9.15.4 Construction

The pit shall be excavated in accordance with its design dimensions (depth and sidewall area) and the bottom shall be made as level as possible. Bottom and sidewall areas shall be raked to minimize smearing and enhance infiltration. If ground water is encountered during pit excavation, the pit shall be backfilled with the original soil to a level at least three feet higher than maximum ground water and adjustments made to the proposed pit dimensions (a redesign of the system is needed and minimum pit separation distances are maintained). Impermeable overburden shall not remain in the bottom of an excavated pit.

At least a six (6) inch layer of large aggregate (3/4 to 2-1/2 inch size) shall be placed over the entire pit bottom and leveled. A twelve (12) inch layer of large aggregate placed over the entire pit bottom is recommended. If footing rings are needed, they shall be installed on the leveled bottom layer of large aggregate. Perforated rings shall be installed upon the footing rings or directly upon the leveled bottom layer of large aggregate. Additional rings shall be installed as needed. The annular space between the perforated rings and the pit sidewall shall be filled with large aggregate to the bottom of the inlet pipe elevation. The watertight four (4) inch minimum diameter inlet pipe shall be installed with a minimum slope of 1/8 inch per foot. The annular ring of large aggregate shall be covered by a permeable geotextile, untreated building paper or a four (4) inch layer of hay or straw to prevent soil from filling the aggregate voids.

A reinforced concrete structurally sound pit cover capable of supporting 300 pounds per square foot at its weakest point shall be installed. A manhole and removable cover with an opening of at least 20 inches in the shortest dimension shall be installed and its top shall be located six (6) to twelve (12) inches below grade. A manhole cover location marker (such as treated lumber or concrete post) should be installed above the top of the cover to finished grade for future maintenance. Permeable soil shall be used as backfill to fill the remaining excavation to grade with some mounding to allow for settlement. The upper six (6) inches of the permeable backfill may be topsoil to facilitate future seeding to grass. On sloped sites, a diversion ditch or berm should be constructed uphill from the pit(s) to prevent surface water from entering the pit(s).

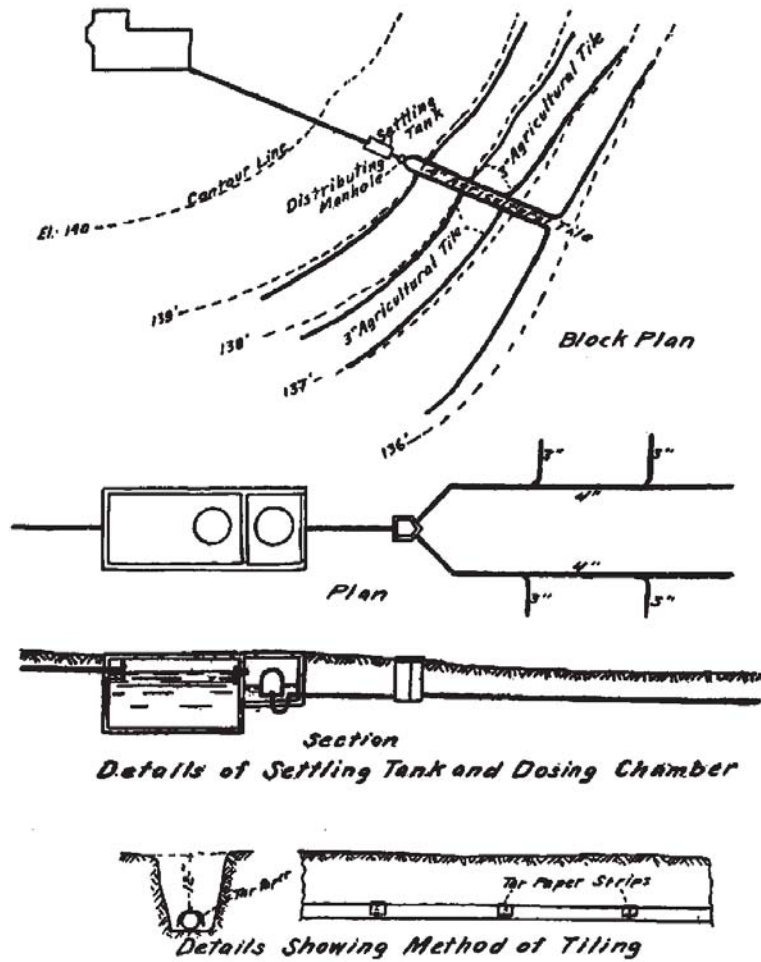

FIG. 6
 SHOWING ARRANGEMENT AND DETAILS OF SUBSURFACE IRRIGATION SYSTEM — GENTLE
 SLOPING GROUND

“The Disposal of Human Excreta and Sewage of the Country Home”
 Theodore Horton, C.E., Director of Sanitary Engineering
 NYSDOH
 Published October 5, 1916

This diagram is for historical interest only. Do not use for plan or design preparation.

Chapter 10

Alternative Subsurface Onsite Wastewater Treatment Systems

10.1 General Information

The treatment systems addressed in the previous conventional subsurface treatment section may be used on sites with useable soil percolation, acceptable horizontal separation distances and adequate vertical separation distances to boundary conditions. Alternative subsurface treatment systems described in this section can be installed when site conditions do not allow the use of conventional subsurface treatment systems. There will be sites, however, that are not suitable for residential development using conventional or alternative systems. Such sites may require public sewers or community onsite treatment systems for residential development to avoid creation of public health hazards/nuisances.

Sites compatible with development using alternative systems generally require a more detailed site and soil evaluation, a more complicated design, costly construction and components requiring regular maintenance. It is recommended that all OWTSSs have the construction supervised as needed, an “as-built” developed for the homeowner and the system installation certified by the design professional. This may be even more important for alternative systems that have a more complicated design and distinctive construction requirements. The most commonly used alternative systems include raised systems, mounds and intermittent sand filters.

10.2 Raised Systems

10.2.1 General Information

A raised system comprises a conventional absorption trench system constructed in stabilized permeable fill placed above the original ground surface on a building lot.

10.2.2 Site Requirements

A raised system may be used where site investigation demonstrates all of the following conditions exist:

- (1) There is at least one (1) foot of useable original soil with a percolation rate between one (1) and 60 mpi above any impermeable soil layer, bedrock or maximum high ground water level.
- (2) Slope in the proposed absorption facility and expansion area shall not exceed 15%.
- (3) All minimum horizontal and vertical separation distances as described in **Figure 28, Figure 29 and Table 2** must be maintained for the proposed system and expansion area.

10.2.3 Design Criteria

Design of a raised system, as depicted in **Figures 28 and 29**, shall be based upon the daily design flow rate and the results of a site investigation including: topography, slope, ground water elevation, depth to impermeable soils and bedrock, rock outcroppings, soil permeability, vegetation and land drainage

At least two (2) percolation tests shall be performed at one (1) foot below grade in the proposed location of a raised system to verify the in-situ soil is useable. At least one (1) deep hole test shall be dug at the proposed location of a raised system to verify boundary conditions. At least one (1) percolation test and one (1) deep hole test should also be performed at the proposed location of the raised system expansion area.

Percolation tests shall be conducted: in the in-situ fill material, at the borrow pit and after the fill material is stabilized at the construction site. Conducting percolation tests of in-situ borrow pit soils to be used for fill provides a good indication of eventual stabilized fill percolation rates. The slower of the percolation test results between the in-situ borrow pit soils and the stabilized fill material at the site shall be used for design of an absorption trench system. Construction of the absorption trench system in the fill material area is identical to that of a conventional absorption trench system, including laterals being installed parallel to contour lines for the native soil prior to installing fill.

The total quantity and dimensions of fill required to be placed at the construction site shall be based upon the design of the basal area plus a minimum twenty (20) foot taper. The taper shall be sloped no greater than one (1) vertical to three (3) horizontal.

The basal area is defined as the total area beneath the absorption trenches extending 2.5 feet from the outer edge of the trenches. The minimum size of the basal area shall be calculated using an application rate of 0.2 gpd/ft². **Table 9** lists basal areas for standard daily design flows using 0.2 gpd/ft² for septic tank effluent. The use of slowly permeable soils for the fill material will result in a trench system requiring a larger basal area.

Sufficient stabilized soil with a percolation rate between five (5) and thirty (30) minutes per inch is required to maintain at least two (2) feet separation between the proposed bottom of the absorption trenches and any boundary condition. Preferred fill material is comprised of sand or sandy loam with a percolation rate of five (5) to ten (10) minutes per inch to minimize construction and operation problems. Very permeable fill materials should be avoided to prevent surface exposure of inadequately treated wastewater from too rapid movement through the fill. Slowly permeable fill material should also be avoided to prevent impeded wastewater movement through the fill. If the in-situ unsaturated soil has a percolation rate faster than one (1) minute per inch, sufficient stabilized soil with a percolation rate between five (5) and thirty (30) minutes per inch is required to maintain at least two (2) feet separation between the proposed bottom of the absorption trenches and in-situ soil.

The edge of the fill material beyond the basal area shall be tapered at a slope no greater than one (1) vertical to three (3) horizontal with a minimum taper length of twenty (20) feet. All minimum horizontal separation distances as described in **Table 2** shall be measured from the outer edge of the taper since the fill is considered a system component.

The fill must be stabilized prior to conducting final percolation tests and construction of the absorption trench system. Soils whose permeability characteristics could change significantly upon stabilization (soils containing clay and/or silt) shall be allowed to settle naturally for a period of at least six (6) months and include one freeze-thaw weather cycle. Soils whose permeability characteristics will not change significantly upon stabilization (sand and sandy loam) may be mechanically compacted or

allowed to settle naturally as indicated above. Mechanical compaction shall be achieved via track type machines (bulldozer or front-end loader with downward blade/bucket pressure) or steel wheeled roller. Mechanical compaction shall be accomplished in shallow lifts [approximately six (6) inches] to the approximate density of the undisturbed borrow pit soil. Compaction must be carried out carefully to avoid creating layers of different density.

Distribution to the absorption trench system shall incorporate dosing, unless: (a) the system is to be installed under the jurisdiction of a local health department which has a program incorporating site evaluation, system design approval and construction inspection/certification, and (b) a minimum of two (2) feet of fill material with a percolation rate of five (5) to thirty (30) minutes/inch shall be placed between the bottom of the trenches and the existing ground.

Curtain drains may be used on the uphill side of proposed fill areas on sloped sites to intercept and control ground water where high ground water levels exist. Non-perforated pipe constructed to convey ground water from the perforated drain pipes to the ground surface should be installed on in-situ soil bedding at least five (5) feet from the toe of the slope of the fill material. Excavated soil shall be used as backfill around and above the non-perforated pipe. The drainpipe surface outlet shall be protected from water infiltration, soil erosion and animal entry. This method of controlling groundwater level should be monitored to confirm effectiveness to ensure the absorption area maintains the two (2) foot separation to groundwater year-round. This method will not be effective on flat sites.

On sloped sites, a diversion ditch or curtain drain shall be constructed uphill from the fill to prevent surface runoff from entering the fill area. The topsoil surface of the fill shall be graded to enhance runoff of precipitation. Short-circuiting of wastewater to any nearby drainage systems shall be avoided.

10.2.3.1 Raised System Receiving ETU Effluent

ETU effluent contains much less BOD and TSS than septic tank effluent. The receiving soil will act as a final polishing media and distribute the treated wastewater into the soil. Due to the ETU effluent quality, the volume of soil and surface area needed for treatment is reduced. Consequently, the minimum size of the basal area of a raised system designed to receive effluent from an ETU can be calculated based upon an application rate of 0.3 gpd/ft². **Table 9** shows raised system basal areas receiving effluent from ETUs using standard daily design flows. A conventional absorption trench shall be designed to distribute effluent evenly over the fill material basal area. All other design and construction requirements for raised systems shall apply.

As previously discussed, ETUs need to be properly maintained in accordance with the manufacturer's recommendations. ETUs shall be located in an area where ETUs are subject to the jurisdiction of a RME, local sanitary codes or watershed rules or regulations that incorporate the requirement to maintain and service ETUs.

10.2.4 Construction

Preparation of the site on which the fill is to be located and placement of fill on the site are critical to proper operation of the raised system. Extreme care must be taken to assure that construction techniques do not compromise the integrity of the receiving soils or fill material. Heavy construction equipment must not be allowed within the area where the raised system is to be installed.

Generally, sites with large trees, numerous small trees, or large boulders are unsuitable for a raised system because of the difficulty in preparing the surface and the reduced infiltration area beneath the system. Consideration should be given to increasing the size of the system to provide sufficient soil

to accept the effluent when tree stumps and/or boulders occupy a significant amount of the soil surface area. In areas that are suitable, all trees and stumps shall be cut at grade and removed. Other vegetation (brush, vines, weeds, grass) shall be cut as close to grade as possible and removed. All leaves, limbs and boulders above grade shall also be removed. Root structure below grade should not be removed. Plowing the area where the fill is to be placed “turns” over the soil without destroying the soil structure or infiltrative capability of the receiving soils. When the surface is plowed, a plow with at least a double-bottomed blade/furrow plow with the furrow turned upslope is recommended. If other equipment (such as teeth from the bucket of a backhoe) or another method is used it must not destroy soil structure and cause smearing or compaction of receiving soils. Rototilling or soil scarification with construction equipment should always be avoided.

After the site has been cleared and plowed all traffic shall be excluded from the area. Fill material can be deposited on the site with a front-end loader or pushed on from the side, preferably the upslope side, using a track type machine with at least six (6) inches of fill beneath the tracks. At no time should ruts be made in the plowed area.

Fill should be placed on the site immediately after it is prepared to avoid undesirable changes to the native soil (traffic, compaction, erosion, etc.). The fill shall be properly stabilized and the absorption trench system shall be constructed in the fill material.

After the absorption trenches have been constructed in the stabilized fill (including backfilling the trenches), the entire surface of the raised system including the tapers shall be covered with a minimum of six (6) inches of topsoil, slightly mounded to enhance runoff of precipitation from the system ($\geq 1\%$ slope) and seeded to grass.

Appropriate curtain drains and diversion ditches shall be constructed uphill from the absorption system on sloped sites to prevent ground water from interfering with absorption system operation or surface runoff from entering the fill.

10.3 Mounds

10.3.1 General Information

A mound system is a soil absorption system that is elevated above the natural soil surface in specified fill material. Mounds are a variation of the raised system except a specified and analyzed (sieve analysis) sandy fill material is utilized. The type of soil used does not require a stabilization period (freeze-thaw) prior to construction of the absorption trenches or bed in the fill. For sites with permeable soils of insufficient depth to groundwater, creviced rock or porous bedrock for a conventional absorption system, the specified fill material in the mound provides the necessary treatment of wastewater. The overall size of a mound system will usually be substantially smaller than a raised system because of the combination of using a specified fill material, the improved solids retention of the required multi-compartment septic tank or tanks in series and the required pressure distribution (i.e., uniform distribution of settled effluent within the absorption area) results in high treatment efficiencies.

Installation of water saving devices such as; faucets, showerheads, toilets and clothes washers are recommended for any residence using a mound system to minimize wastewater flow. When mound systems are proposed as replacement systems for existing homes, water saving fixtures should replace older household plumbing fixtures. Siting and design experience indicates that a mound should be long and narrow and should follow the site contour.

10.3.2 Site Requirements

A mound system may be used where site investigation demonstrates all of the following conditions exist:

- (1) There is at least two (2) feet of naturally occurring soil above bedrock.
- (2) The maximum high ground water level must be at least one (1) foot below the natural ground surface.
- (3) The percolation rate of the naturally occurring soil shall be between one (1) and 120 minutes per inch in the upper foot of soil.
- (4) Slope of the original ground surface at the proposed absorption facility plus the expansion area shall not exceed 12%.
- (5) All minimum horizontal and vertical separation distances as described in **Figures 30, 31, 32A, 32B, Table 2 and Table 4** must be maintained for the proposed system and the reserve area (if available).

10.3.3 Design Criteria

Design of a mound system shall be based upon the daily design flow rate and the results of a site investigation including topography, slope, ground water elevation, depth to impermeable soils and bedrock, rock outcroppings, soil permeability, vegetation and land drainage. Site modification is not acceptable to attain the required maximum 12% slope (i.e., the natural site must have a slope not exceeding 12%). Percolation and deep hole tests are required. At least one deep hole test at least four (4) feet deep or to bedrock shall be dug at the proposed location of the mound system to verify boundary conditions. Mound systems are depicted in **Figures 30, 30A, 31, 31A, 32, 32A and 32B**.

The basal area of a mound system is defined differently than a raised system. The basal area for a mound system on level ground includes all the area beneath the absorption trenches or bed and the area under the surrounding tapers (basal area = [LW]). On 1% to 12% sloping sites the basal area includes only the area under the absorption trenches or bed and the lower or downhill taper only.

Mound Basal Area (level site) = [LW] as shown in **Figure 30A and 31A**.

Mound Basal Area (sloped site) = $\left[\left(\frac{B + L}{2} \right) (C) + AB \right]$ as shown in **Figures 30A and 31A**.

All minimum horizontal separation distances depicted in **Table 2** shall be met and measured from the outer edge of the taper since the fill is considered a system component. All minimum vertical separation distances depicted in **Figure 30, 31 shall be met**, and dimension D in **Figures 32A and 32B** must be at least one (1) foot. The required basal area is dependent upon the daily design flow rate and soil percolation test results of naturally occurring soil. Trench lengths listed in **Table 6A** or calculated from **Table 6B** for trenches, and basal areas listed in **Tables 7A** or calculated from **Table 7B** for absorption beds, shall be used when the percolation rate is between one (1) and sixty (60) minutes per

inch. An application rate of 0.2 gallons per day per square foot shall be used when the in-situ soil percolation rate is 61 to 120 minutes per inch. Percolation test holes shall be approximately twelve (12) inches deep to determine the percolation rate of the upper foot of naturally occurring soil. Percolation tests should be conducted near each end of the proposed mound and the expansion area. The slowest percolation test results (worst case observed within the selected basal area) shall be used to design the basal area required. At least one (1) deep hole test should be performed at the proposed location of the reserve area to verify boundary condition separation, if available.

The recommended separation distance between two (2) or more mound systems (toe of slope of fill to toe of slope of fill), perpendicular to ground contours is at least thirty (30) feet. Heavy construction equipment shall not be allowed within the basal area and a recommended minimum 20 feet wide area downslope of the basal area, which acts as a dispersal area for the mound.

Percolation tests for the fill material shall be conducted at the borrow pit in areas representative of the soil to be obtained. Only uniform medium to course sand with a percolation rate between five (5) and thirty (30) minutes per inch shall be used for the fill material. Sands with greater than 10% by weight finer than 0.075 mm (i.e., # 200 sieve) must be avoided. Note that the 0.05 mm material requirement listed in Appendix 75-A is a numerical error and inconsistent with the commonly used U.S. Sieve Series of a #200 sieve with a 0.075mm opening. At least 25% of the material by weight shall be in the range of 0.50 to 2.0 mm. Less than 15% of the material by weight shall be larger than a 1/2 inch sieve. A sieve analysis is recommended and may be necessary to verify compliance with the soil specifications.

MOUND SAND SPECIFICATIONS	
Percolation rate	5- 30 mpi (5-10 mpi preferred)
Fine material (silt, clay)	Less than 10% by weight (#200 sieve)
Course material (stone, gravel)	Less than 15% by weight (1/2 inch mesh sieve)
Medium to Course Sand	At least 25% by weight (#35 sieve to #10 sieve)
Effective Grain Size	0.15 - 0.30mm
Uniformity Coefficient	4 - 6

Note: ASTM C33 washed concrete sand will typically meet the above suggested mound sand criteria and will typically be available at most sand and gravel distributors; however, this material will often have a percolation rate faster than minimum five (5) minutes per inch. The percolation rate should be verified and take precedence to the fill gradation requirements when a mound is placed over very slow percolating soil to avoid rapid weeping of fluids at the ground surface.

A pressure distribution network shall be utilized and timed dosing is recommended to control discharge to the mound. The width of the system shall be kept to a minimum and, in no case, shall the absorption area be wider than 20 feet (i.e., distance between the outside edges of bed or trenches) as depicted in **Figures 30 and 31**. A mound shall not be expanded greater than 20 feet wide to satisfy absorption system expansion. In a distribution network using a central-manifold, distribution lines shall have a maximum total length of 200 feet (end cap to end cap) as depicted in **Figure 16**. In a distribution network using an end-manifold, distribution lines shall have a maximum length of 100 feet (manifold pipe to end cap) as depicted in **Figure 15**. The overall size of absorption facilities in a mound (bed or trenches) shall not exceed 20 feet by 205 feet for a central manifold distribution network or 20 feet by 105 feet for an end manifold distribution network.

Figures 30A, 31A, 32, 32A and 32B are referenced for calculating mound dimensions. The letter dimensions are explained below.

A = absorption trench or bed total width and shall not exceed 20 feet.

B = absorption trench or bed total length and shall not exceed 205 feet for a central manifold or 105 feet for an end manifold.

C = downslope setback and shall be the larger of: (1) approximately three (3) times the height of the mound at the downslope edge of the absorption facility ($[3] [E + F + G]$); or, (2) the dimension calculated from percolation tests on the naturally occurring soil plus flow rates to meet the required basal area.

D = depth of fill at the upslope edge of the absorption facility between the top of the plowed surface and the bottom of the absorption facility and shall be at least one (1) foot.

E = depth of fill at the downslope edge of the absorption facility between the top of the plowed surface and the bottom of the absorption facility and shall be equal to $[D + (\text{slope of site}) (A)]$.

D = E for level sites.

F = depth of aggregate in the absorption trench or bed and shall be at least 9.5 inches (i.e., \geq six (6) inches of aggregate plus \geq 1.5 inches of distribution pipe diameter plus \geq two (2) inches of aggregate). Gravelless absorption products may be used in place of aggregate in accordance with the manufacturer's recommendations on a 1:1 basis only (mound and absorption area dimensions shall remain the same).

G = depth of permeable soil cover plus topsoil at the upslope and downslope edges of the absorption facility and shall be at least one (1) foot [i.e., \geq six (6) inches of permeable soil cover and \geq six (6) inches of topsoil].

H = depth of permeable soil cover plus topsoil at the width center of the absorption facility and shall be at least 1.5 feet [i.e., \geq one (1) foot of permeable soil cover plus \geq six (6) inches of topsoil].

J = upslope setback and shall be at least:

$$[3(D + F + G)] - [\text{Slope of Site}] [(3) (D + F + G)] = [1 - \text{Slope of Site}] [(3) (D + F + G)].$$

K = side slope setback and shall be at least three (3) times the total height of the mound:

$$[3][(\frac{D + E}{2}) + F + H].$$

L = total length of mound and equals $[B + 2K]$. The length shall be parallel to the site contours.

$W =$ total width of mound and equals $[A + C + J]$. The width shall be perpendicular to the site contours.

The permeable soil cover shall extend beyond the aggregate at least 1.5 feet with the top surface having a slope not exceeding one (1) vertical to three (3) horizontal. Mound dimensions shall be consistent with **Figures 30, 30A, 31, 31A, 32, 32A and 32B** and meet or exceed those required by the local health department having jurisdiction.

The required absorption area of the trenches or bed shall be based upon the daily design flow rate and the percolation rate of the in-situ fill material (at the borrow pit). Trench lengths are listed in **Table 6A** or calculated from **Table 6B** for trench systems, and basal areas are listed in **Table 7A** or calculated from **Table 7B** for absorption beds.

A dual chamber septic tank or two tanks in series in addition to the dosing tank (with pump storage) shall be provided. An effluent filter or other outlet modification that enhances solids retention in the tank(s) is recommended.

10.3.4 Construction

Preparation of the site where the mound is to be located, placement of fill, construction of the absorption trenches or bed, grading the exposed fill, grading and seeding the top soil are critical to proper operation of the mound system. The in-situ soil beneath the mound basal area must be capable of absorbing the filtered effluent of the mound. Extreme care must be taken to assure that construction techniques do not compromise the integrity of the mound system or receiving soils. Heavy construction equipment must not be allowed within the fill area of the system or immediately downslope of the system. The downslope area provides effluent dispersal for the mound system. Placement of fill material or construction of absorption facilities in fill shall not occur when the soil moisture content is high.

Generally, sites with large trees, numerous small trees or large boulders are unsuitable for a mound system because of the difficulty in properly preparing the surface and the reduced infiltration area available beneath the system. In areas that are suitable, all trees and stumps shall be cut at grade and removed. Other vegetation (brush, vines, weeds and grass) shall be cut as close to grade as possible and removed. All leaves, limbs and boulders above grade shall also be removed. Root structure below grade should not be removed. Rototilling or soil scarification with construction equipment is not allowed. The proposed mound area shall be plowed to a depth of about seven (7) to eight (8) inches preferably with a double-bottomed blade/furrow plow with the furrow turned upslope or a backhoe equipped with plowing blades. Other methods that will promote infiltration and not destroy soil structure may also be used.

After the site has been cleared and plowed all traffic shall be excluded. Fill should be placed on the site immediately after it is prepared to avoid undesirable changes to the plowed native soil, (traffic, compaction, erosion). Fill material can be deposited on the site with a front-end loader or pushed on from the side (preferably the upslope side) using a track type machine with at least six (6) inches of fill beneath the tracks. At no time should ruts be made in the plowed area.

The fill material shall cover the entire mound area. The required trenches or bed shall be constructed in the fill. Construction of the absorption system in the fill material shall be in accord with **Figures 30, 30A, 31, 31A, 32, 32A and 32B**, including distribution laterals being installed parallel to the contour lines of the native soil prior to installing fill. The bottom of the absorption system shall be level. The bottom and sidewalls of the absorption trenches or bed shall be raked prior to installing. The

aggregate in the trenches or bed shall be completely covered with a permeable non-woven geotextile to prevent infiltration of soil into the aggregate.

The tapered slopes of the fill shall not exceed one (1) vertical to three (3) horizontal. The entire mound including the tapers shall be covered with six (6) inches of topsoil and seeded to grass.

Appropriate curtain drains and diversion ditches shall be constructed uphill from the mound on sloped sites to prevent ground water from interfering with absorption system operation or surface water from entering the mound.

10.4 Intermittent Sand Filters

10.4.1 General Information

Intermittent sand filters, as depicted in **Figure 33**, utilize the intermittent application of settled wastewater to a bed of specified and layered granular material with under drains to collect and discharge the filtered effluent. Effluent is intermittently spread across the surface of a bed of specified sand (at least 24 inches thick) via perforated distribution lines installed in an upper layer of aggregate. A three (3) inch layer of 1/8 to 1/4 inch diameter washed crushed stone or washed gravel is placed beneath the sand layer and above a layer of 3/4 to 1-1/2 washed aggregate (at least ten (10) inches thick). Perforated collector pipes are installed in the bottom layer of aggregate to collect filtered wastewater for distribution to a subsurface soil absorption area for final treatment. Sand filter effluent shall be discharged to a subsurface absorption facility (to a downstream absorption mound or modified shallow trench system).

Intermittent sand filters and downstream absorption systems should only be used on large lots. These systems are not intended for use where the surface soil is impermeable since the absorption system would exhibit continuous weeping. The downstream absorption system may exhibit some weeping of double-filtered wastewater during the wet season. Hence, the absorption systems should be located distant from residences and property lines.

10.4.2 Site Requirements

An intermittent sand filter system may be used where site investigation demonstrates all of the following conditions exist:

- (1) All horizontal separation distances shown in **Table 2** must be maintained for the proposed sand filter plus the downstream absorption system. All minimum horizontal separation distances shall be measured from the outer edge of the taper of the absorption system and outer edge of the sand filter.
- (2) The bottom of the sand filter collector pipes shall be at least two (2) feet above the maximum high ground water elevation.
- (3) Determine that development of the site with a sand filter and downstream absorption system is consistent with the overall development of the area and will cause no adverse environmental impacts.

10.4.2.1 Downstream Modified Mound

A modified mound, as depicted in **Figure 34**, may be used following a sand filter where site investigation demonstrates the following conditions exist:

- (1) The natural slope of the site of the downstream mound must not exceed 12%.
- (2) The percolation rate in the upper six (6) inches of in-situ soil at the proposed mound site should be no slower than 120 minutes per inch. The percolation rate for a twelve (12) inch deep percolation test hole has no limitation (it may be much slower than 120 minutes per inch).

10.4.2.2 Downstream Modified Shallow Trench System

Note that Appendix 75-A refers to using an absorption bed instead of trenches. Due to the increased effective sidewall infiltration area per lineal foot, however, trenches are preferred over absorption beds. A modified shallow trench system, depicted in **Figure 35**, may be used following a sand filter where site investigation demonstrates the following conditions exist:

- (1) The natural slope of the downstream-modified shallow trench must not exceed 15%.
- (2) The percolation rate in the upper six (6) inches of in situ soil at the proposed downstream modified shallow trench system site should be no faster than one (1) minute per inch and no slower than sixty (60) minutes per inch. The percolation rate for a twelve (12) inch deep percolation test hole has no limitation (it may be much slower than sixty (60) minutes per inch).

10.4.3 Intermittent Sand Filter - Design Criteria

The maximum allowable daily effluent application rate to the sand filter shall be 1.15 gpd/ft² when pressure distribution or dosing is used and 1.0 gpd/ft² for gravity distribution.

Design of an intermittent sand filter and downstream absorption system shall be based upon the daily design flow rate and the results of a site investigation including topography, slope, ground water elevation, rock outcroppings, soil permeability, vegetation and land drainage. An intermittent sand filter is depicted in **Figure 33**. An impervious material such as a 30-mil plastic liner or a six (6) inch layer of relatively impermeable clay is recommended to be used under and along the sides of all proposed sand filters. This is especially the case when located upon any rock, shale or other susceptible geology to prevent short-circuiting of wastewater to an aquifer and to minimize surface water infiltration. When a liner system is used, a daily design flow figure of 100% should be used for the downstream mound or modified shallow trench system sizing.

Septic tanks installed upstream of an intermittent sand filter shall have dual compartments or two tanks in series. Use of an effluent filter on the septic tank outlet is strongly recommended. An effluent filter or gas deflection baffle is required when a garbage grinder can reasonably be expected at the time of construction or in the future.

Pressure distribution or a dosing system shall be used to apply effluent to a sand filter with 300 lineal feet or more of distributors or 900 square feet or more of filter area. Pressure distribution or dosing is recommended for all sand filters; however, gravity distribution may be used for sand filters of less than 300 lineal feet of distributors or less than 900 square feet of filter area. Pressure distribution

pumps shall be selected to maintain a minimum pressure of one psi (2.3 feet of head) at the downstream end of each distributor line during the distribution cycle. Perforated distributor lines shall be installed a maximum of three (3) feet center to center and 1.5 feet from the filter sidewall.

The downstream end of each pressure distributor shall be capped. Perforated pressure distribution lines shall be one (1) to three (3) inches in diameter and installed level.

The downstream end of each dosed distributor may be capped or vented (via an individual or common vent). Perforated distributor lines for dosed systems shall be three (3) to four (4) inches in diameter and installed level.

The downstream end of each gravity distributor may be capped or vented (via an individual or common vent). Perforated distributor lines for gravity systems shall be four (4) inches in diameter and have a slope of 1/16 to 1/32 inch per foot.

When soil cover above the filter (above the permeable geotextile and aggregate surrounding the distributors) exceeds 24 inches, the downstream end of distributors (when dosed or gravity flow is used) or the upstream end of collector pipes (when pressure distribution used) should be manifolded and connected to a downward facing screened vent to provide oxygen to the wastewater-sand interface.

Four (4) inch diameter perforated collector pipes beneath the filter shall be centered between distributor pipes, have a maximum center to center spacing of twelve (12) feet, have a maximum spacing from the filter sidewall of six (6) feet and have a slope of 1/16 to 1/8 inch per foot. The liner or soil surface beneath the filter shall be sloped toward the trenches in which the underdrains are laid. The trenches beneath the underdrains shall have a slope of 1/16 to 1/8 inch per foot.

It is recommended that the distribution system to the sand filter utilize pressure distribution. Whether pressure distribution or dosing is utilized, the filter should be dosed at least (5) times daily based upon the daily design flow rate. Timed dosing is the preferred dosing method to control dosing times and allow for consistent resting periods. For pump or siphon dosing, the volume of each dose should be approximately 75% of the volume of the distribution lines or five (5) times a day whichever is smaller.

It is recommended to incorporate design methods of improving oxygen exchange within the filter such as increasing the dose frequency (thus reducing dose volume) and/or including a venting system in the filter with vents extended to the atmosphere. Vents may need to include an odor-scouring device such as an activated carbon filter installed on the end of the vent.

The granular sand treatment layer of media must be coarse enough to permit a sufficient flow rate yet fine enough to provide adequate treatment. Media that is too coarse lowers the wastewater retention time to a point where treatment becomes inadequate. Media with small grain size slows the water movement and increase the chance of clogging. The effective grain size (EGS) and uniformity coefficient (Uc) are the principal characteristics of granular media treatment systems. The sand media shall have an EGS of 0.25 to 1.0 mm (i.e., sieve sizes number sixty (60) to slightly larger than number twenty (20)). The EGS is defined by the size of screen opening where 90% of a sample of granular media is retained on the screen and 10% passes through the screen and is referred to as D_{10} . A log-log plot of mechanical sand analysis is used to determine EGS. If nitrification is not required by the local health department, the EGS shall be in the range of 0.5 to 1.0 mm (i.e., sieve sizes slightly smaller than number thirty (30) to slightly larger than number twenty (20)). All sand shall pass a 1/4 inch sieve.

The Uc of the sand shall not exceed 4.0 (i.e., $D_{60}/D_{10} \leq 4.0$ where D_{60} is the size of sieve opening at which 60% of the sand particles pass through and 40% is retained and D_{10} is the size of sieve opening at which 10% of the sand particles pass through and 90% is retained). The uniformity coefficient is a numeric estimate of how sand is graded, and is a dimensionless number. The term “graded” relates to where the concentrations of sand particles are located by size. Sand with all the particles in two (2) size

ranges would be defined as narrowly graded sand and would have a low U_c . Sand with near equal proportions in all the fractions would be defined as widely graded sand and would have a high U_c value. The larger the U_c the less uniform the sand. It is important that the sand grains all be relatively uniform (a smaller U_c).

INTERMITTENT SANDFILTER SAND SPECIFICATIONS	
Uniform course to medium sand	Minimize fines: < 4% passing #200 sieve
Effective Grain Size (EGS)	0.25 - 1.00mm
Uniformity Coefficient (U_c)	≤ 4

Note: ASTM C33 washed concrete sand will not typically meet the preferred intermittent sand filter sand criteria because there will typically be too much fine material. Modification can be made to limit the amount of fines by having less than 4% pass a #200 sieve. Most sand and gravel distributors should be able to manufacturer this material.

10.4.3.1 Downstream Modified Mound - Design Criteria

Effluent from the sand filter collector pipes is most often discharged to a mound that is constructed above the original ground surface. The size of the mound shall be based upon the estimated quantity of filtered effluent reaching the sand filter collector pipes and an application rate of 1.2 gpd/ft². to a mound utilizing absorption trenches regardless of the underlying soil percolation rate at twelve (12) inches below grade. Absorption beds are not allowed in a mound following a sand filter. A percolation rate no slower than 120 minutes per inch is necessary in the upper six (6) inches of in situ soil to prevent rapid fluid seepage on the soil surface.

Some of the effluent applied to the sand filter may percolate the soil beneath an un-lined sand filter. The estimated quantity of effluent reaching the sand filter collector pipes shall not be less than 85% of the daily design flow rate to the sand filter. If the percolation rate of the soil beneath the sand filter is approximately 120 minutes per inch, a design flow figure of 85% may be used. If a percolation rate of ≥ 180 minutes per inch occurs at the soil beneath the sand filter, a daily design flow figure of 95% may be used. If a liner system is used or an impermeable clay soil exists, a design flow figure of 100% should be used.

The site for a proposed downstream mound plus the expansion area shall not exceed 12% slope for naturally occurring soil. Downstream modified mound designs shall be similar to mound designs as discussed in Section 10.3 of this Handbook and as shown in **Figure 34**. Fill material for a downstream mound shall consist of medium sand with a percolation rate tested at the borrow pit, between five (5) and thirty (30) minutes per inch. All minimum horizontal and vertical separation distances as described in **Figure 34, Table 2 and Table 4** shall be met for the proposed downstream mound system and expansion area. The six (6) inch layer of permeable soil should extend 100 feet radially from the downstream mound in the direction of flow. Since mounds downstream from a sand filter may exhibit some weeping during the wet season, the mounds should be located distant from the residence and at least 100 feet from any property line.

A pressure distribution network is required and the distribution laterals shall be installed parallel to the contours of the site. The width of the system (up and down slope) shall be no wider than twenty (20) feet (outside edge of trench to outside edge of trench). Construction concerns previously noted for mound systems are applicable to mounds receiving sand filter effluent.

Differences between Mounds and “Modified Mounds” Following a Sand Filter:

Design Feature	Mound	Modified Mound
Absorption Area Option	Trenches or Bed	Trenches Only
Application Rate	Varies based upon percolation rate of fill material and absorption area type	1.2 gpd/ft ²
Daily Design Flow	100%	85% - 100%
Depth of Fill Between Plowed Grade and Bottom of Trench(es)	1 foot	2 feet
Useable soil Depth (1-120mpi)	1 foot	6 inches
Basal Area for slope	Varies with slope %	Not applicable

If a specific waiver is granted to allow use of gravity distribution to a downstream mound (in lieu of required pressure distribution), recommended design modifications include: (a) the trench lengths listed in **Table 6A** or as calculated from **Table 6B** are used (this means absorption beds would not be allowed) and (b) the perforated distribution lines shall not exceed sixty (60) feet in length.

10.4.3.2 Downstream Modified Shallow Trench - Design Criteria

A modified shallow absorption trench system may be used in-lieu-of a downstream mound to provide subsurface dispersal of sand filter effluent when at least six (6) inches of in-situ unsaturated soil with a percolation rate of one (1) to sixty (60) minutes per inch exists. Sufficient soil similar to the in-situ permeable soil fill shall be provided to assure a trench depth of at least eighteen (18) inches with a minimum one (1) foot depth of aggregate filled sidewall contacting permeable soil as shown in **Figure 35**. Trenches shall be designed upon the estimated quantity of effluent reaching the collector pipes and an application rate of 1.2 gpd/ft² for two (2) feet wide trenches. Parallel trench sidewalls shall be separated by six (6) feet of soil and shall be located at least 20 feet from drainage ditches. Trenches should be as long as possible to minimize multiple parallel trenches. Distributor length shall not exceed 60 feet for gravity flow and 100 feet for pressure distribution. The finished slope of the fill shall not exceed one (1) vertical to three (3) horizontal and the area must be seeded with grass.

10.4.4 Intermittent Sand Filter – Construction

Preparation of the site on which the sand filter is to be located includes clearing of excess vegetation (including trees, stumps, roots and brush), excavation of filter area and site grading.

Following excavation and grading, perforated collector pipes are installed in the sloped filter bottom designed to direct passing filtered wastewater to the collector pipes. Collector pipes are installed at a slope of 1/16 to 1/8 inch per foot. At least two (2) inches of aggregate (washed gravel or crushed stone 3/4 to 1 1/2 inches in diameter) shall surround the lower half of the four (4) inch diameter collector pipes. At least four (4) inches of aggregate shall underlay the entire system (above the graded soil and above the top of the collector pipes) and its upper surface shall be as level as possible.

A three (3) inch layer of 1/8 to 1/4 inch diameter washed gravel or crushed stone shall be spread across the entire bed of aggregate to minimize movement of the specified filter sand media into the aggregate and collector pipes.

A minimum of 24 inches of approved filter sand (EGS of 0.25 to 1.0 mm and all sand passing a 1/4 inch sieve, $U_c \leq 4.0$) shall be placed above the three (3) inch layer of 1/8 to 1/4 inch stone or gravel.

The filter sand layer should be settled by “flooding and release” before distribution pipes and aggregate is placed on top of the sand bed.

A two (2) inch layer of aggregate shall be placed upon the entire sand bed. A distribution network (gravity, dosing or pressure distribution) shall be installed on the aggregate. Additional aggregate shall be installed to provide a minimum depth of four (4) inches across the entire sand surface and at least two (2) inches above the distribution pipes. **Figure 33** depicts the recommended uniform eight (8) inch layer of aggregate containing distributor pipes across the entire sand surface.

Permeable non-woven geotextile, untreated building paper or four (4) inches of hay or straw shall be placed over the entire bed of aggregate to prevent the infiltration of fine soil into the sand filter media. The entire surface of the filter shall be covered with six (6) to twelve (12) inches of topsoil mounded to enhance runoff of precipitation from the filter ($\geq 1\%$ slope) and seeded to grass. Appropriate diversion ditches or berms shall be constructed uphill from the sand filter on sloped sites to prevent surface runoff from entering the sand filter.

10.4.4.1 Downstream Modified Mound – Construction

Construction of a downstream absorption mound shall be in accordance with all conditions noted in Section 10.3.4 of this Handbook.

10.4.4.2 Downstream Modified Shallow Trench – Construction

Construction of a modified shallow trench system shall be in accordance with construction criteria for shallow trench systems in Section 9.12.4 of this Handbook. Modified shallow trenches shall be constructed in the fill and at least six (6) inches into the in-situ permeable and unsaturated soil.

Chapter 11

Other Onsite Wastewater Treatment or Wastewater Management Systems

In rare cases where a soil absorption area cannot be installed because water and plumbing are not available, power is not available or to resolve a failing system on limited sites, “wastewater containment” or a “no discharge” type system may be necessary or more practicable as a means of wastewater treatment or management. For these systems, the residual or accumulated wastes must be removed periodically by a NYSDEC permitted septage waste transporter and either taken to a wastewater treatment plant or disposed of in another approved manner. Examples may be hunting camps, remote camps or boat only access lands.

11.1 Holding Tanks

The use of holding tanks shall not be used for new residential construction regardless of full-time or part-time occupancy, except when temporary occupancy of a dwelling is allowed while the OWTS is under construction or when installation is delayed due to weather conditions (such as freezing temperatures or excessive rain). Holding tanks are only intended to meet the above noted exception or to correct existing failing OWTS when no other alternative exists. Holding tanks are not deemed acceptable for long-term use at year-round residences due to high maintenance costs and continuous operation attention. If considered on a permanent basis due to extreme hardship to replace a failed system and no other options are available, approval may be required by the local code enforcement official (CEO), LHD or other agency having jurisdiction.

Tank size shall be based upon a minimum of five (5) days design flow or 1,000 gallons, whichever is greater, and meet the same construction standards as a septic tank except that the holding tank shall not have an outlet. The holding tank must be designed, installed and maintained in a way that promotes ease of access for pumping and cleanup. Holding tanks should be provided with access to grade. The access should be provided with a cover that is water tight and lockable to prevent inappropriate or unapproved access. Holding tanks may need to be properly vented through the house vent stack to avoid odor issues and related nuisances.

All holding tanks shall be equipped with an alarm (audible and visual) located in a conspicuous place to indicate when pump out is necessary. The owner should have a contract for service with a NYSDEC permitted septage waste transporter to pump the holding tank as needed. A solenoid valve on the water service line to the household (upstream of all fixtures and immediately downstream of a hydropneumatic tank, if one exists) should also be considered to avoid holding tank overflows. Water saving fixtures should be installed and water saving practices should be implemented in any home being

served by a holding tank to minimize pump out maintenance costs. Waste management districts or RMEs are recommended for areas with numerous holding tanks to provide continuous inspection and maintenance services.

11.2 Non-Waterborne Systems

11.2.1 General Information

The Residential Code of New York State requires wet plumbing (potable water and wastewater treatment system) for all new residences. Minimal required plumbing fixtures may be omitted for owner-occupied single-family dwellings if approved by the local code enforcement official. The water distribution and wastewater treatment system of any building or premises where plumbing fixtures are installed shall be connected to an existing public water supply or public sewer system, respectively, if available. When either a public water supply or public sewer system, or both, are not available or connection is not feasible, a residential water supply (drilled well) or residential OWTS or both, shall be provided. In some areas of the State where in the unusual case available water becomes insufficient to economically use flush toilets or where a need exists to conserve water, the use of non-waterborne systems may be justified and allowed at the discretion of the local health department or other agency having jurisdiction. In those cases, other household wastewater (greywater) from sinks, showers, tubs, and other fixtures must receive proper treatment (septic tank and soil absorption). Greywater systems shall be designed upon a flow of 75 gpd/bedroom and meet all the criteria previously shown for treatment of residential wastewater in this handbook. Due to the potential for contamination from pathogens, greywater should not be used for any type of irrigation purposes (vegetable or flower gardens, lawns, trees, etc.) and shall receive proper subsurface treatment.

11.2.2 Composters

These units accept human waste into a chamber where composting of the waste occurs. Composter units shall be installed and maintained in accordance with the manufacturer's instructions. The units shall have a label indicating compliance with the requirements of NSF Standard 41 or equivalent. Only units with a manufacturer's warranty of five (5) years or more shall be installed.

Composting toilets are designed to store and compost by aerobic bacterial digestion only toilet wastes and kitchen food scraps. To enhance digestion, supplemental additions of carbon-rich bulking agents such as vegetable matter, grass clippings, leaves, finely chopped straw, wood chips, planer shavings or coarse sawdust are added to the waste pile. The greywater originating from bathing facilities, sinks and washing machines must be collected, treated and disposed separately. Composters also need to be located and vented so that they can be operated and maintained without creating a public health hazard or odor nuisance. Household cleaning products should not be placed in the unit. Failure to add adequate bulking agents or maintain adequate moisture can result in the composting pile becoming hard and difficult to remove or become anaerobic. The composted humus contains numerous bacteria which could be pathogenic (cause disease). Due to potential exposure to pathogens, it is recommended that homeowners not personally remove the residual wastes (composted humus) and instead arrange for the residual wastes to be periodically removed by a NYSDEC permitted septage waste transporter.

11.2.3 Chemical and Recirculating Toilets

Chemical toilets provide a toilet seat located directly above a vault containing chemicals to disinfect and control odors from the wastewater. Recirculating toilets use chemicals as the toilet flush liquid. The wastes are separated from the liquid and discharged to an internal holding tank. The chemical liquid is reused for additional toilet flushing. The liquids used in these types of toilets do not completely disinfect the wastes so the residual waste products shall not be discharged to surface waters or the ground surface. The reduced volume wastewater from recirculating toilets may be discharged to a larger holding tank but not to a subsurface absorption system due to the presence of chemicals in the liquid. Residual wastes or spent chemical liquid in these systems shall be periodically removed by a NYSDEC permitted septage waste transporter.

11.2.4 Incinerator Toilets

These units accept human waste into a chamber where the wastes are burned. The units have a very limited capacity and require a source of electricity or fuel to burn the wastes. The units should be certified in accordance with National Sanitation Foundation (NSF) Protocol P157 or equivalent. The ash remains must be periodically removed and should be disposed according to local solid waste regulations. The units must be installed in accordance with the manufacturer's instructions. These units routinely produce objectionable odors at the start of each incineration cycle as the temperature rises to its proper operating range. To avoid creating public health nuisances from objectionable odors, the separating distance from the unit exhaust stack to the nearest property line or other habitable buildings should be at least 500 feet.

11.2.5 Privies and Out-Houses

Approval for the installation of a privy for a “single family occupied residence” may be required by the local code enforcement official and/or local health department. Privies and out-houses may be an excavated pit, watertight vault, or removable watertight receptacle. Privies and out-houses are the least desirable wastewater treatment/management systems, particularly excavated pits that discharge into the underlying soils. A composter or vault type privy is preferred. If an excavated pit type privy is installed, the pits shall be constructed in soil with the bottom of the pit at least two (2) feet above bedrock and/or maximum high ground water. **Table 2** separation distances for non-waterborne systems shall be met. An excavated pit is assumed to be on-site discharge vs. a watertight vault emptied by a NYSDEC permitted waste transporter (offsite residual disposal)

The privy structure shall be fly and vermin tight with a self-closing door, screened vents, and screened exterior openings. Conventional toilet seats may be installed for user comfort. The toilet seat is located directly above the receiving pit/vault/receptacle. Grading should prevent entrance of surface water into the pit. When excreta in the pit is within 18 inches of ground level, the pit contents should be removed/pumped out or covered with 18 inches of soil. The framed enclosure is usually constructed to facilitate pump out or relocation over a new pit. Pump out of vaults or exchanges of receptacles shall be accomplished before the vessel is full and causes interference with use. The waste contains numerous bacteria which could be pathogenic (cause disease). Due to potential exposure to pathogens, it is recommended that homeowners not personally remove the residual wastes and instead arrange for the residual wastes to be periodically removed by a NYSDEC permitted septage waste transporter.

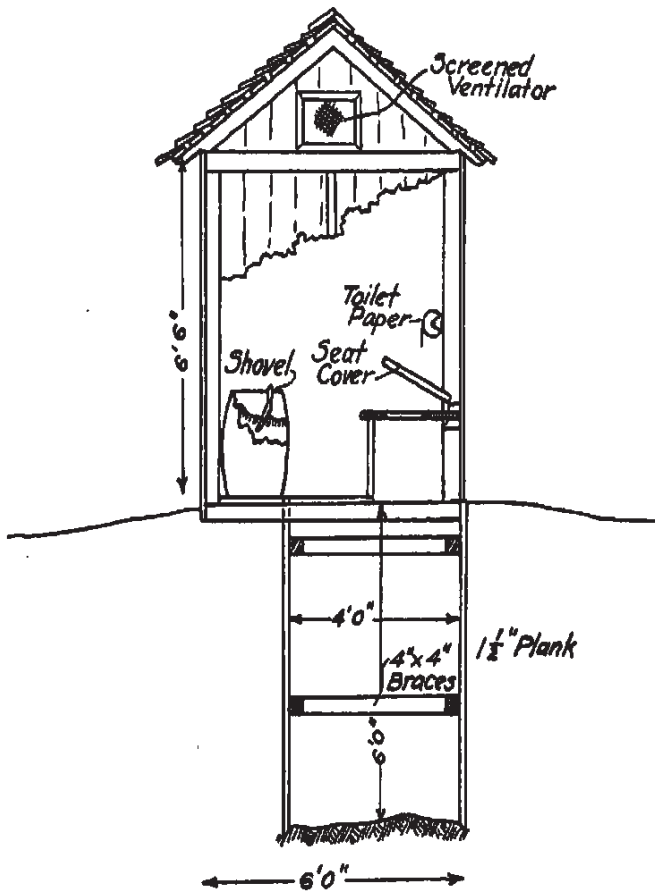

FIG. 1
PRIVY WITH VAULT

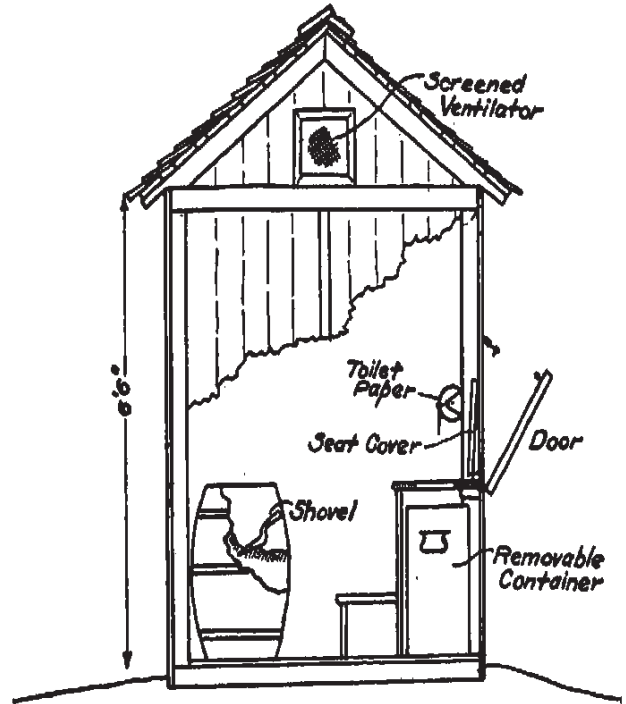
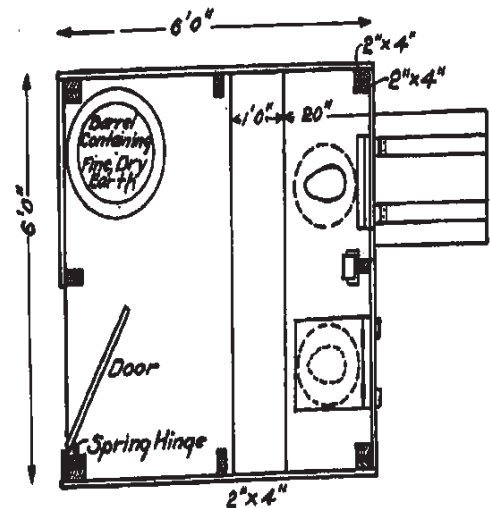
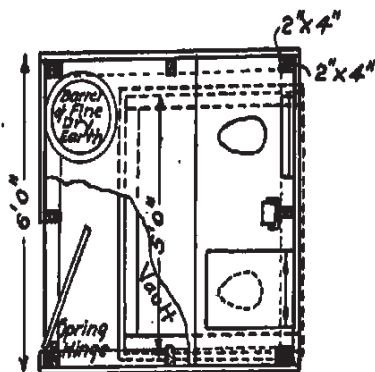

FIG. 2
PRIVY HAVING REMOVABLE CONTAINER



“The Disposal of Human Excreta and Sewage of the Country Home”

Theodore Horton, C.E., Director of Sanitary Engineering
 NYSDOH

Published October 5, 1916

This diagram is for historical interest only. Do not use for plan or design preparation.

Chapter 12

Operation and Maintenance of Onsite Wastewater Treatment Systems

OWTSs will not function properly if left unattended. A household OWTS will function satisfactorily if it is properly located, designed, constructed and maintained. To assure that OWTSs function satisfactorily, owners should observe the following practices for operating and maintaining their systems. Information is also available for guidance to homeowners in the NYSDOH document, “Septic Systems - Operation and Maintenance”. Design professionals, developers, contractors, pumpers, inspectors should provide this document to homeowners to reinforce the need to properly care for and maintain their OWTS and its components. A copy of the guide is provided in **Appendix F** and is available on the NYSDOH website at <http://www.health.ny.gov/environmental/outdoors/septic/>.

12.1 Inspection & Maintenance of OWTS Components

12.1.1 Septic Tanks

The contents of the septic tank should be pumped out every two (2) to three (3) years, or whenever any of the following conditions apply:

- (1) The total depth of sludge and scum exceeds 1/3 of the liquid depth of the tank,
- (2) The bottom of the scum layer is within three (3) inches of the bottom of the outlet baffle, or
- (3) The top of the sludge layer is within ten (10) inches of the bottom of the outlet baffle.

A NYSDEC licensed septage waste transporter (septic tank pumper) can measure tank layers with a “sludge judge” or similar device and pump out the tank if necessary. Pump out clearances noted above also apply to any chamber in multi-compartment tanks and to any tanks in series.

If the septic tank is not emptied periodically, excess solids can pass into the absorption facility, rapid clogging occurs, premature failure follows and finally, the absorption facility must be repaired or replaced. Periodically pumping a septic tank is far less expensive than replacing an absorption facility. Septic tanks should be inspected annually to determine structural integrity and ensure that the inlet and outlet baffles or tees are in place. All baffles, inlet and outlet piping should be inspected using a strong light. Repairs should be made if necessary.

Some concrete baffles or sanitary tees may deteriorate over time from caustic gases produced in the tank. Baffles and tees, which have deteriorated and no longer perform as designed, must be replaced. The effluent filter and/or gas deflection baffle should be inspected and cleaned following the pump-out of the tank.

Interior surfaces of the tank should be inspected for leaks and cracks using a strong light following pump out of the tank. If a crack or leak below the liquid level cannot be repaired or sealed, the tank must be replaced. If differential (uneven) settlement is evident in the area of the septic tank, the tank must be properly replaced upon a stable foundation of re-graded sand, pea gravel or crushed stone.

**Do not enter a septic tank, it contains toxic gases and the lack of oxygen can cause gas asphyxiation.*

12.1.2 Enhanced Treatment Units (ETU)

ETUs often depend upon mechanical equipment (pumps, blowers, bubblers, control panels) to function properly and continually produce clarified effluent. The periodic inspection and maintenance of the equipment is important to ensure the mechanical and structural components of the units are operating and in good condition. A contract with a manufacturer approved service provider needs to be in place to ensure the unit(s) are inspected and maintained in accordance with the manufacturer's recommendations.

ETUs listed by NSF as Class I, Standard 40 units come with an initial two (2) year maintenance contract, warranty and operating manuals. After two (2) years, the owner needs to continue contracts with qualified service providers to ensure the unit is inspected and maintained in accordance with the manufacturer's recommendations for the life of the unit. Without proper maintenance, these units will fail to perform as designed and reasons for installing the unit(s) will be compromised.

12.1.3 Distribution Devices

Distribution boxes should be inspected periodically to ensure equal flow to all absorption lines and to check for solids leaving the septic tank. The inlet and outlet pipes should be inspected to assure that all outlet inverts are at the same elevation and adjust or install flow equalization devices if necessary. Flow equalization devices (such as speed leveling devices) make it possible to correct unequal flow distribution with minimal effort. Distribution box baffles should be inspected to make sure they are properly positioned. Finding solids in a distribution box is indicative of hydraulic overload, improper septic tank outlet baffles, an undersized septic tank, and/or an overfull septic tank.

Distribution boxes and flow equalization devices permit use of the entire absorption facility and/or periodic resting of portions of oversized absorption facilities (one or more extra trenches). Periodic six (6) months resting of each lateral is very advantageous to absorption facility longevity and is recommended. Periodic resting is easily accomplished by use of adjustable flow equalization devices and outlet plugs in distribution boxes.

A stake should be used to locate distribution box covers below grade. A sketch or plan indicating measured distances from permanent points (corners of house foundation, property stakes, utility poles, etc.) to the covers should be retained and used by the owner. The cover of the distribution box should be kept locked at all times when it is located at or above grade.

12.1.4 Pump and Siphon Systems

Some systems (dosing or pressure distribution systems) incorporate pumps or a siphon, if adequate slope exists. In these cases the pump or siphon chamber must be routinely inspected to ensure proper operation and structural integrity.

Access covers to pump or siphon chambers must be lockable to prevent entry by unauthorized persons, especially children. Pump or siphon chambers frequently contain toxic gases and must not be entered by individuals untrained in proper safe entry protocols. Only properly trained persons should ever attempt to enter or repair such facilities. Pump or siphon chambers must include downward facing and screened air vents, which should be checked periodically for blockage.

When inspecting pump systems, the effluent pump and alarm should be checked for proper operation. If duplex pumps are used, both pumps and alarms should be checked. The pump chamber and plumbing connections should be checked for leaks and groundwater infiltration. Leaks should be repaired promptly. Float switches controlling pumps should be tested and adjusted for correct discharge level.

Siphon dosing systems should be inspected semi-annually to assure the wastewater level in the dosing chamber is within the normal operating range (bottom of bell to below the overflow). The alarm should be checked for proper operation. The alarm should be set to activate prior to wastewater discharging from the overflow pipe. Hydraulic bell siphons and snifter tubes can be tested for leaks by covering the siphon with water and inspecting for air bubbles. The dosing chamber and plumbing connections should be checked for leaks or groundwater infiltration. Leaks should be repaired promptly.

Dosing and pressure distribution system designers and installers should provide homeowners with instructions that describe proper operation and maintenance of the system. If the system is already installed at a time of property transfer, a briefing with the previous owner of their experience with the system may be helpful.

12.1.5 Absorption Facilities

Proper operation and maintenance of OWTSS increases system lifespan, optimizes wastewater treatment and helps to prevent system failures. System failures can pollute the environment and create public health nuisances. Keep trees away from the immediate area of the absorption field as their roots may enter and clog the system. Keep swimming pools (above or in ground) away from the absorption facility. Do not pave or build structures over an absorption facility.

The size of an existing system should be evaluated. Owners should consider increasing the size of an existing septic tank and absorption facilities when additions are made to homes (expansion bedrooms, installation of additional wastewater generating appliances and fixtures, etc.)

Runoff to the absorption area should be eliminated by re-grading, ditching or berming surrounding areas. Groundwater diversion may also be necessary to alleviate high groundwater, which interferes with the proper operation of the facility.

The absorption facility should be observed periodically for surface discharge or ponding of effluent. Such occurrences could indicate system is in need of repair or replacement. Observation ports can be installed at the distal end of the absorption trenches, as depicted in **Figure 36**, to allow monitoring of the trench system.

TYPICAL LAYOUT OF A COVERED SAND FILTER

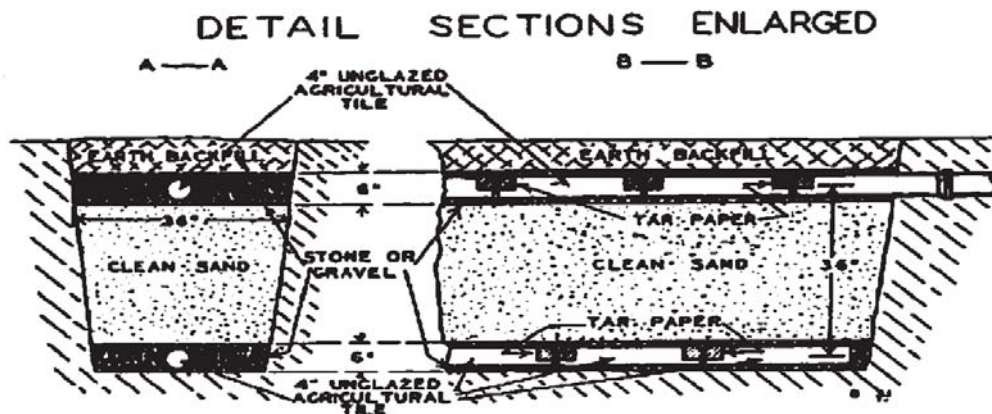
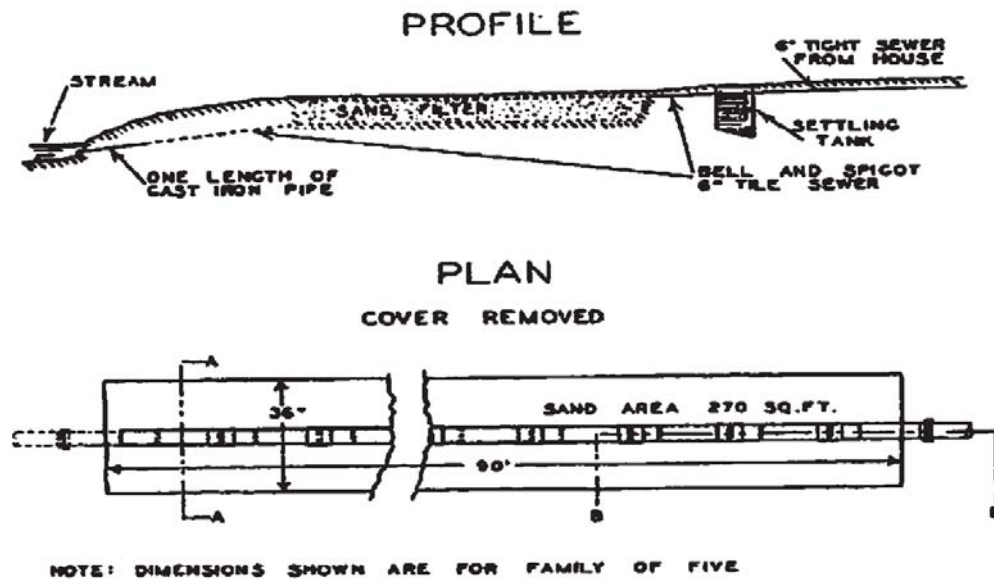

FIGURE 11.

"Rural Water Supply and Sewage Disposal Systems"

C.A. Holmquist, Director, Division of Sanitation

NYSDOH

1932

This diagram is for historical interest only. Do not use for plan or design preparation.

Chapter 13

Addressing System Failure

OWTSs can fail (examples include due to wastewater backup to plumbing fixtures, untreated wastewater on the ground surface, impacts to water courses or contamination of ground water sources such as wells or springs). Failure can be caused by many factors.

13.1 Common Reasons for System Failure

- Improper siting (e.g., soil identification or seasonal high groundwater depth).
- Improper design.
- Poor construction.
- Maintenance deficiencies (no septic tank pumping).
- Hydraulic (water use) or organic overloading (excess food waste and grease).
- Exceeding the useful life of the system (biomat buildup over time).

13.2 Common Reasons for System Overloading

- Leaky plumbing fixtures.
- Change in use with additional bedrooms or conversion of space for more residents.
- Not used as designed for (more bedrooms, residents, vacation rental, home business, etc.).
- Unusually high water usage.
- Overuse of toxic chemicals or high-powered antibiotics that kill beneficial bacteria.
- Surface drainage not directed away from the absorption field area.
- Excessive use of garbage disposals results in solids discharged to the system.
- Septic Tank: not pumped, not watertight or no outlet baffle, excess water or solids discharged.
- Pump Chamber: Incorrect float settings discharge a high volume.
- Septic Tank or Pump Chamber: Infiltration of ground and/or surface water.

13.3 Common System Design or Installation Mistakes

- Soil permeability over estimated results in undersized system.
- Poor fill material or compacted soil resulting in low permeability soil below the system.
- Failure to identify seasonal high groundwater depth; consequently the system becomes too close to or at times within the water table.
- Uneven distribution: part of the system overloaded (adjustment to the distribution box outlets).
- Uneven distribution: part of the system not used because of blockage, broken pipe or uneven settling.

- Excessive backfill over system or installed too deep resulting in limited air exchange.
- Poor quality backfill over system limiting air exchange.
- Failure to install trenches parallel to contours or failure to install trench bottoms level.

Because a number of reasons can lead to system failure or overloading, a careful evaluation of the home, water use, plumbing, wastewater treatment system components and site conditions (soil type, groundwater depth, bedrock, drainage, etc.) should be performed by a design professional or experienced person(s) to determine reasons for problems before developing a solution. The solution may require simple less costly corrections or necessitate a costly system repair or replacement. **Table 11** lists some common reasons for premature failure and some commonly used correction methods or designs.

FIGURES

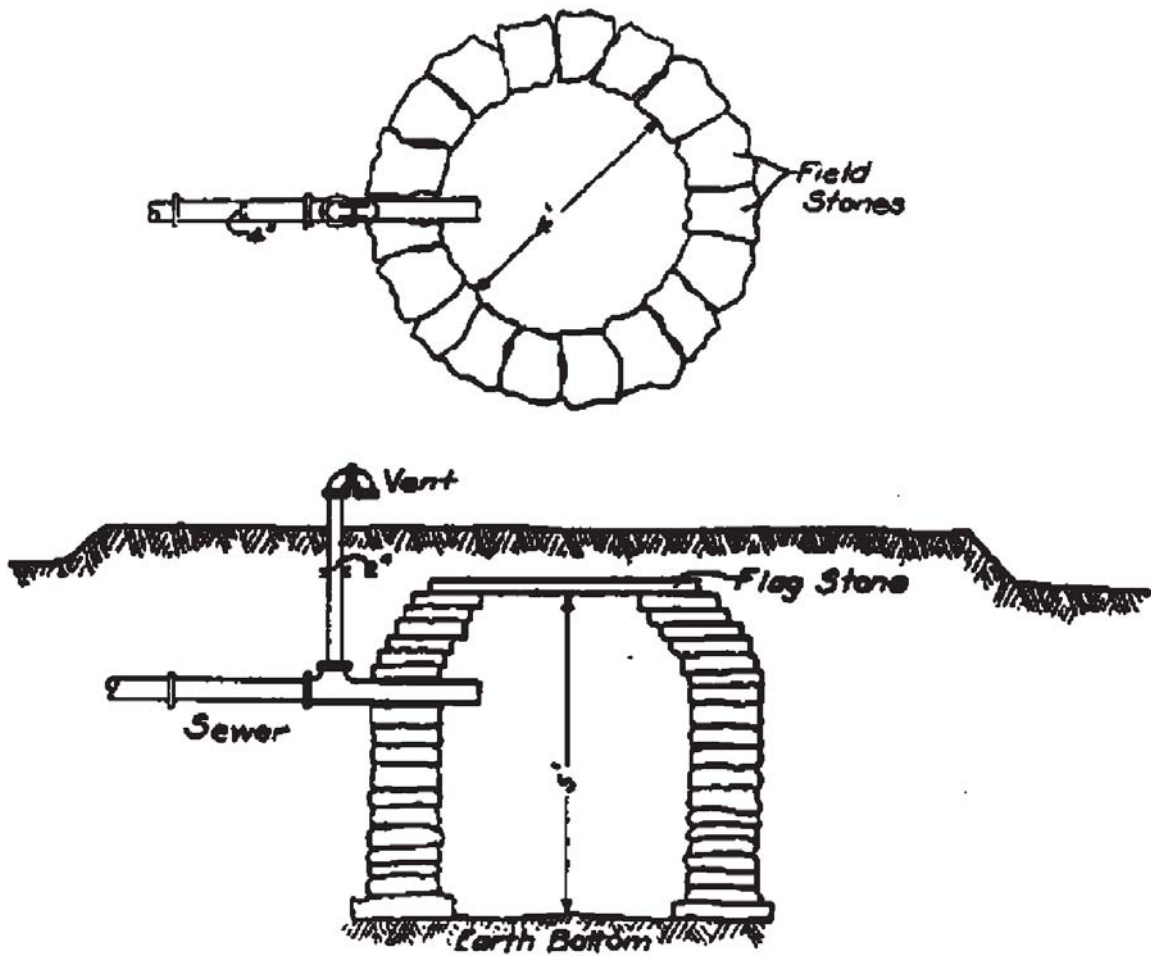

LEACHING CESSPOOL CONSTRUCTED OF FIELD STONES

“The Disposal of Human Excreta and Sewage of the Country Home”

Theodore Horton, C.E., Director of Sanitary Engineering

NYSDOH

Published October 5, 1916

This diagram is for historical interest only. Do not use for plan or design preparation.

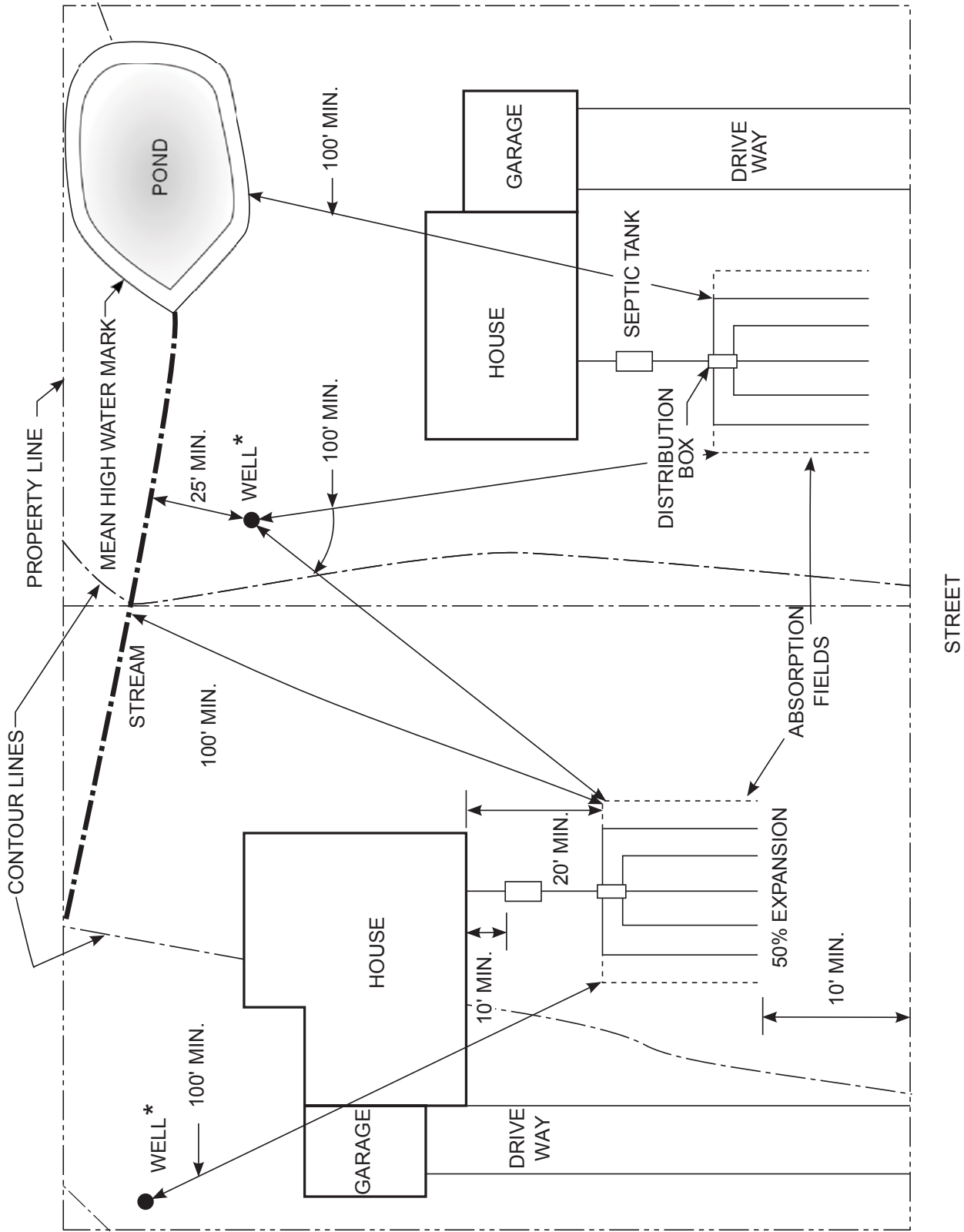

* The listed water well separation distances from contaminant sources shall be increased by 50% whenever aquifer water enters the water well at less than 50-feet below grade. If a 50% increase cannot be achieved, then the greatest possible increase in separation distance shall be provided with such additional measures as needed to prevent contamination

FIGURE 1: ABSORPTION SYSTEM SEPARATION REQUIREMENTS

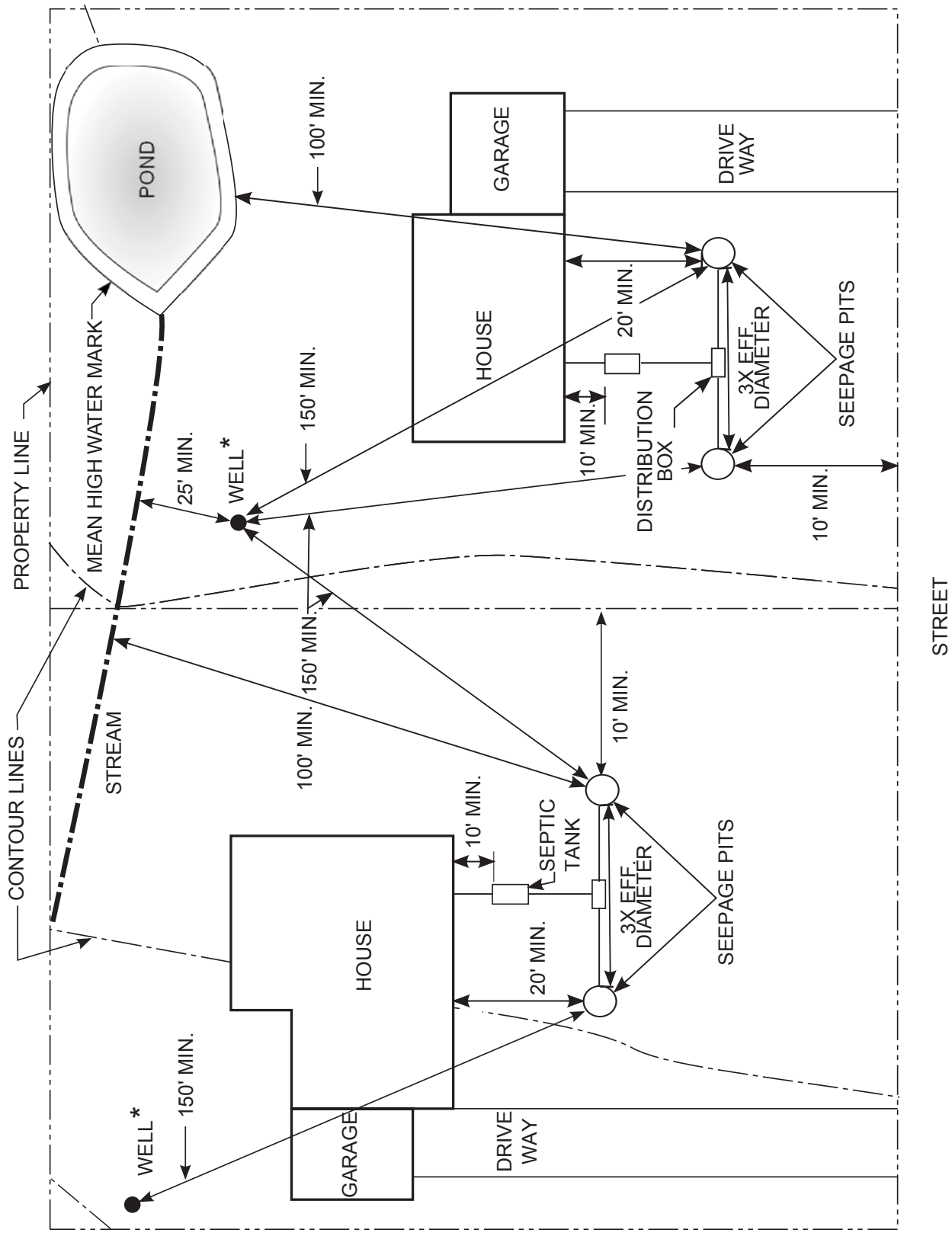

* The listed water well separation distances from contaminant sources shall be increased by 50% whenever aquifer water enters the water well at less than 50-foot below grade. If a 50% increase cannot be achieved, then the greatest possible increase in separation distance shall be provided with such additional measures as needed to prevent contamination

FIGURE 2: SEEPAGE PIT SEPARATION REQUIREMENTS

- Hand dig a hole about 12" diameter - 24" to 30" deep or to the depth of system design. See Table 4 - "Depth of Percolation Test Hole for System Design".
- Scrape sides and remove loose soil from bottom of hole.
- Install measuring stick.
- Place 2" of gravel or crushed stone on bottom.
- Presoak and saturate hole.
- Observe and record the time in minutes required for the water to drop from 6" to 5"
- Repeat the test at least 3 times until the time for the water to drop from 6" to 5" for two successive tests is approximately equal.

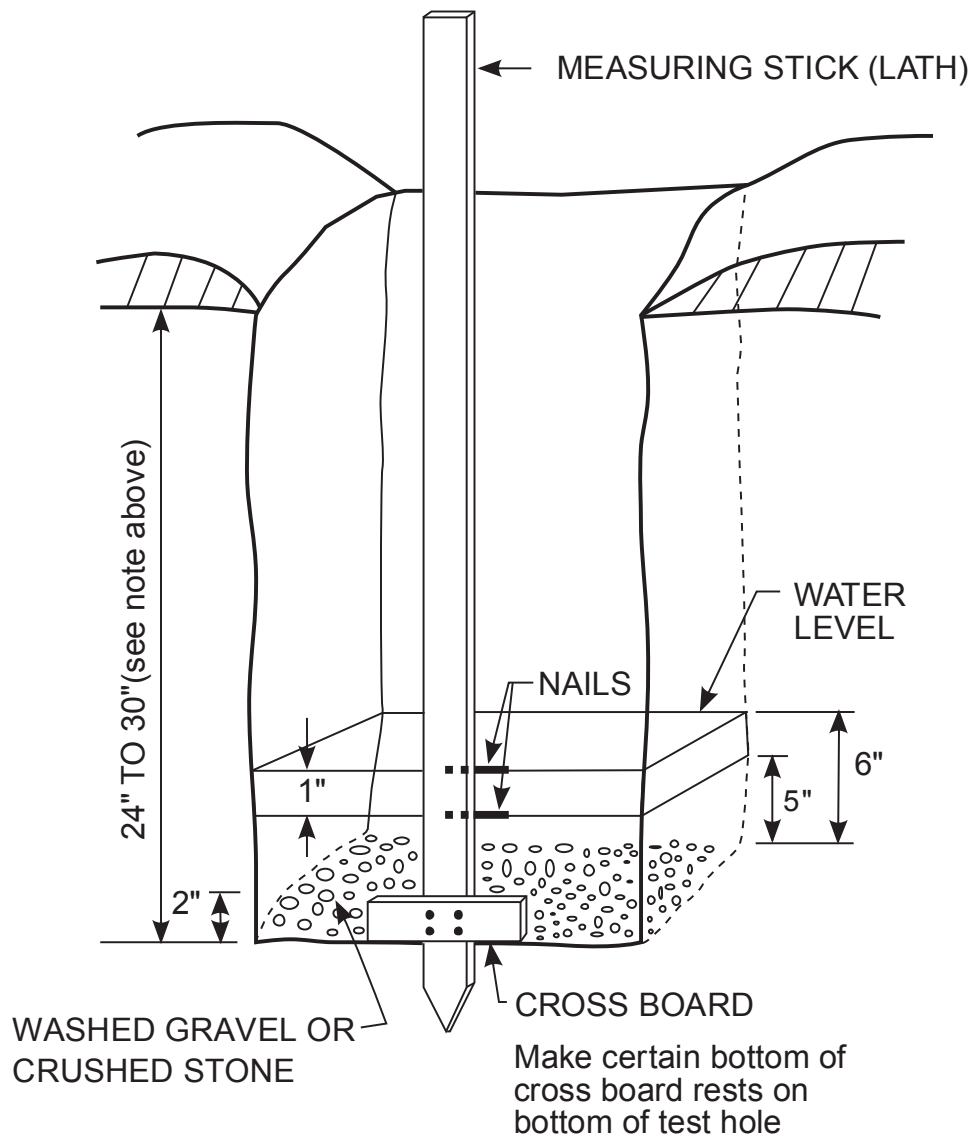
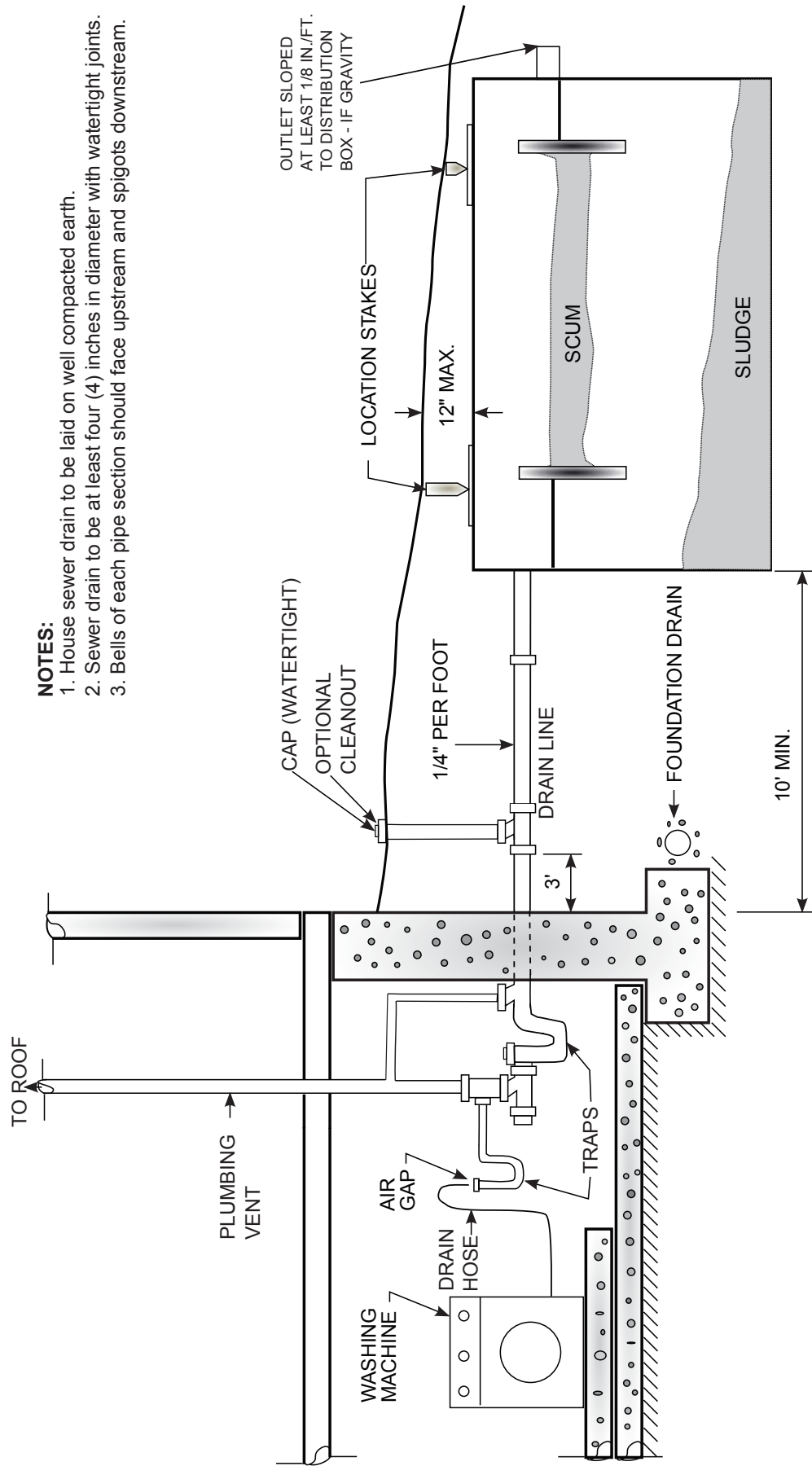

FIGURE 3: SOIL PERCOLATION TEST



NOTES:

1. House sewer drain to be laid on well compacted earth.
2. Sewer drain to be at least four (4) inches in diameter with watertight joints.
3. Bells of each pipe section should face upstream and spigots downstream.

FIGURE 4: HOUSE PLUMBING, VENTING AND HOUSE SEWER DRAIN CONNECTION TO SEPTIC TANK

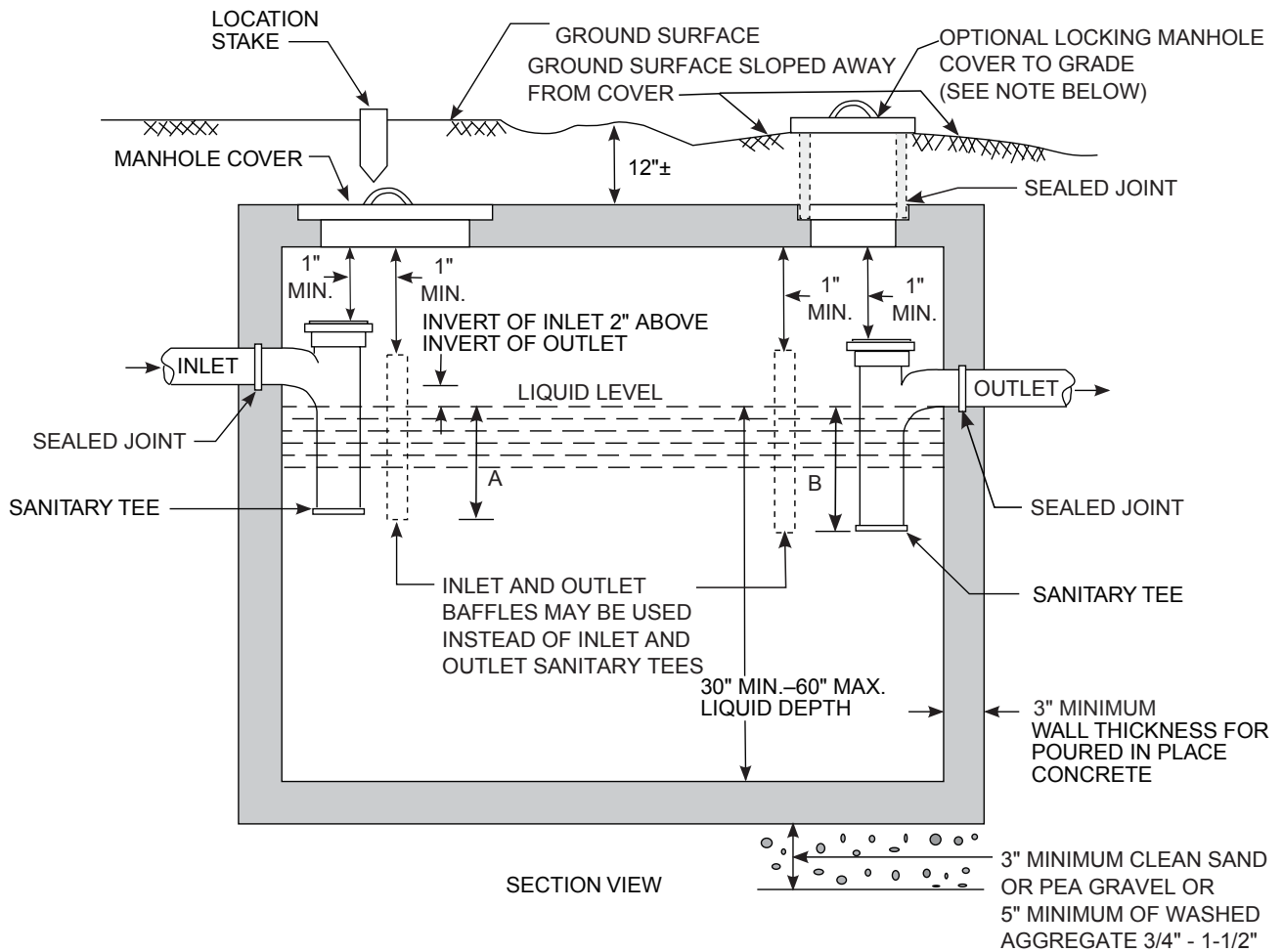

A = 12" MIN. FOR LD < 40" AND 16" MIN. FOR LD ≥ 40"
 B = 14" MIN. FOR LD < 40" AND 18" MIN. FOR LD ≥ 40"

LD = LIQUID DEPTH

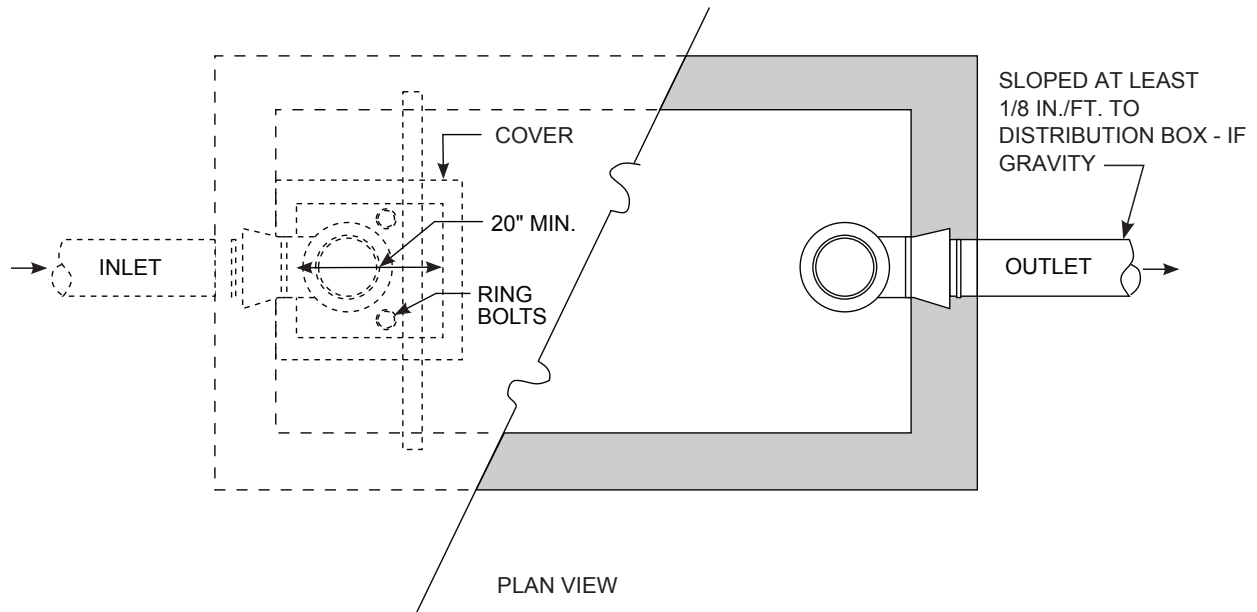

NOTE:

If effluent filter is used on the outlet then locking manhole cover to grade is recommended for maintenance purposes.

FIGURE 5: TYPICAL SEPTIC TANK

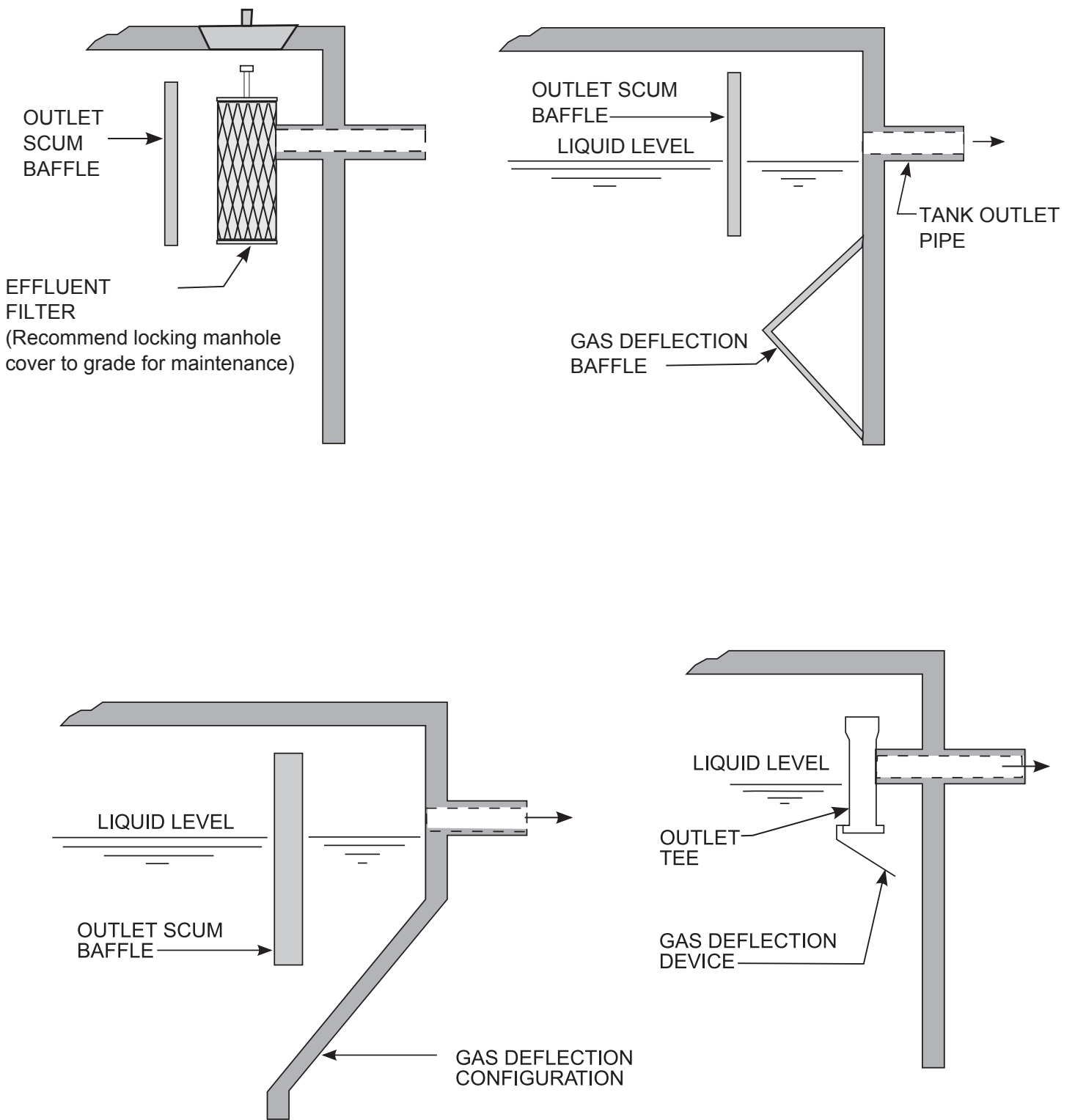
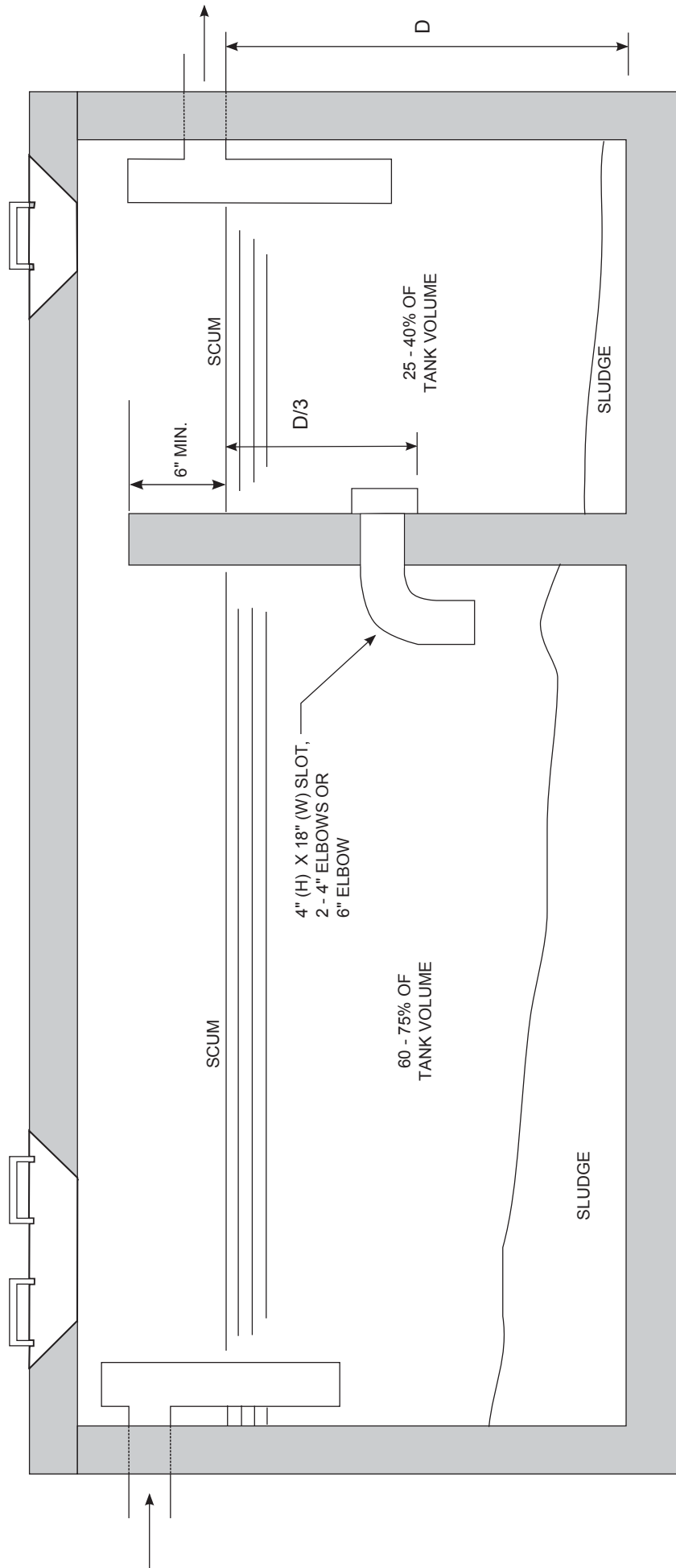

FIGURE 6: EFFLUENT FILTERS AND SEPTIC TANK OUTLET ENHANCEMENTS



NOTES:

1. Connections to compartments shall be located at a distance below the liquid level equal to $1/3$ the distance (D) between the invert of the outlet and the bottom of the tank.
2. At least one access manhole shall be provided into each compartment.
3. Dual compartments are recommended for all tanks and shall be required on all tanks with interior length of ten (10) feet or more.
4. The volume and surface area for meeting the requirements of Table 3 of this handbook shall be based upon the total volume and surface areas of all tanks and chambers.
5. Tanks in series should be connected by a single pipe with a minimum diameter of four (4) inches.
6. A dual compartment septic tank or two (2) tanks in series are required for mounds and sand filters and recommended for all system types.

FIGURE 7: TYPICAL DUAL COMPARTMENT SEPTIC TANK

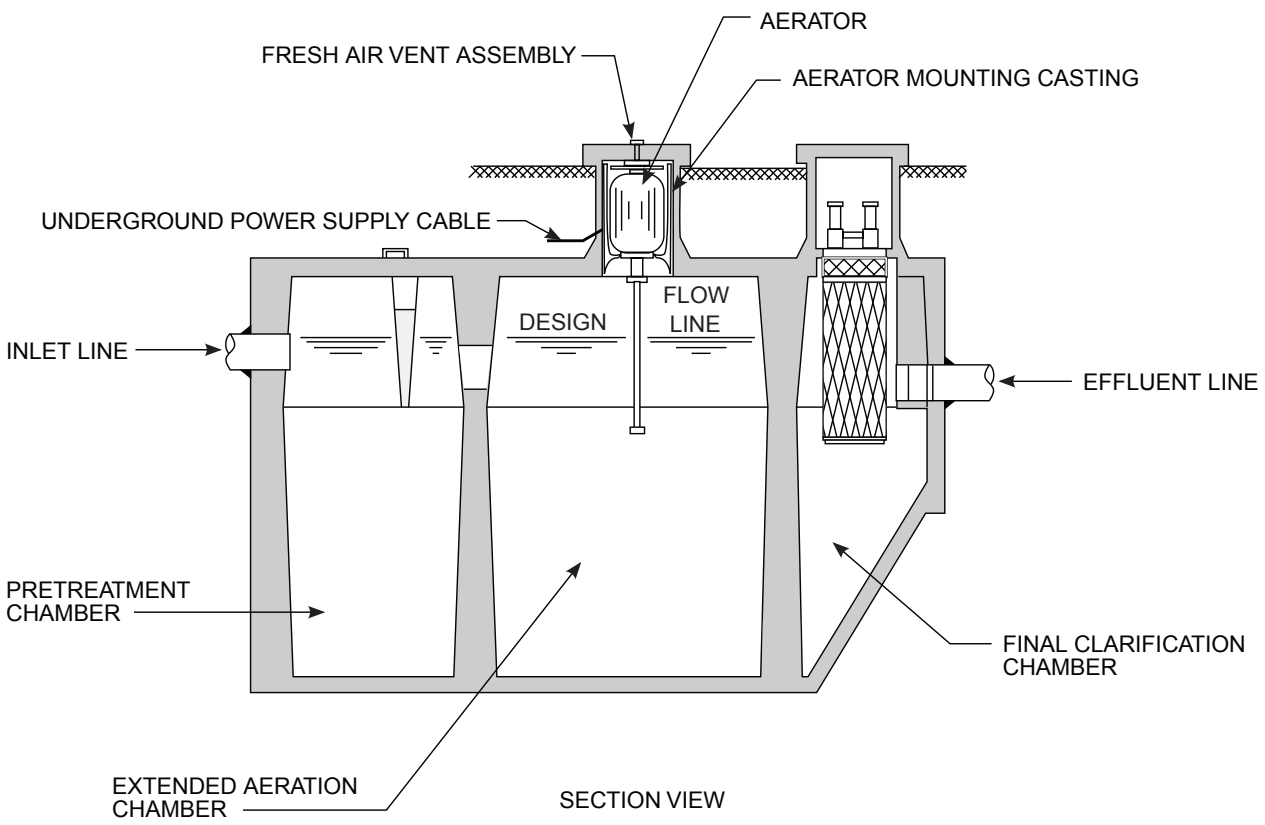
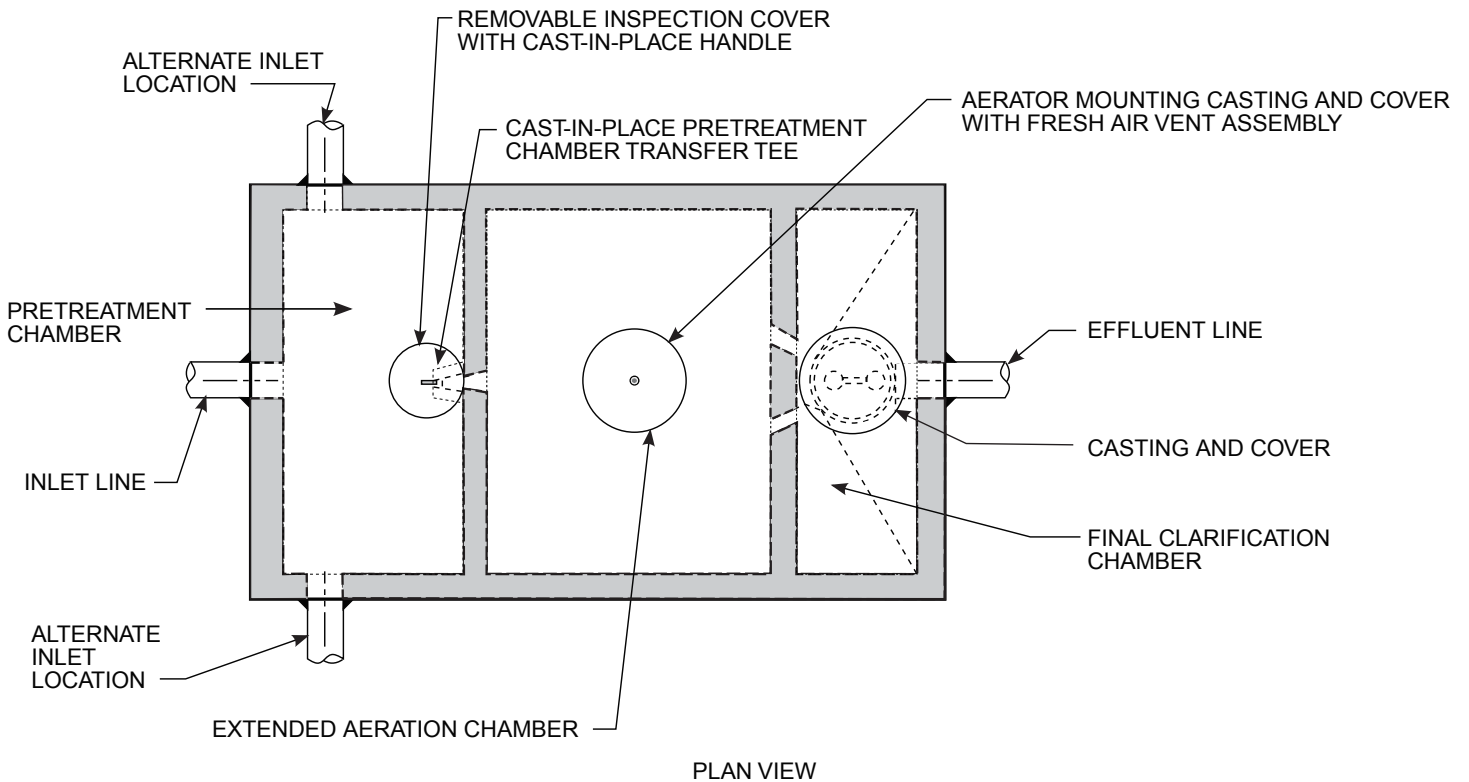

FIGURE 8: EXAMPLE ENHANCED TREATMENT UNIT (ETU): SUSPENDED GROWTH (AERATED)



TEXTILE FILTER



PEAT FILTER

FIGURE 9: EXAMPLE ENHANCED TREATMENT UNIT (ETU): ATTACHED GROWTH (MEDIA)

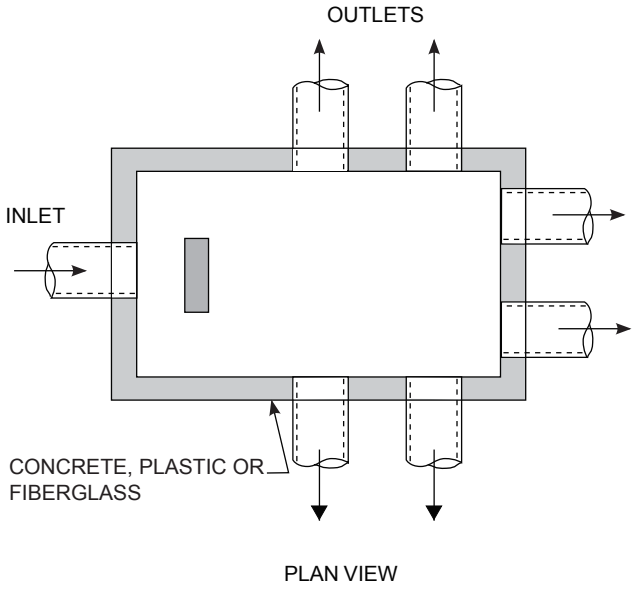

NOTES:

1. Pipe Joints to be sealed with asphaltic material or equivalent.
2. Invert elevations of all outlet pipes must be equal. Use of flow equalization devices is recommended.
3. The pipe from the septic tank to the distribution box inlet, sloped at least 1/8" per foot - gravity.
4. The slope of outlet pipes (header pipes) between the distribution box and distributor laterals should be at least 1/32" per foot.
5. Baffle required for siphon or automatic dosing or if inlet pipe slope exceeds 1/2" per foot.
6. Baffle can be built in or a pipe elbow or tee ("T").
7. The boxes shall be installed in conformance with manufacturer's instructions..

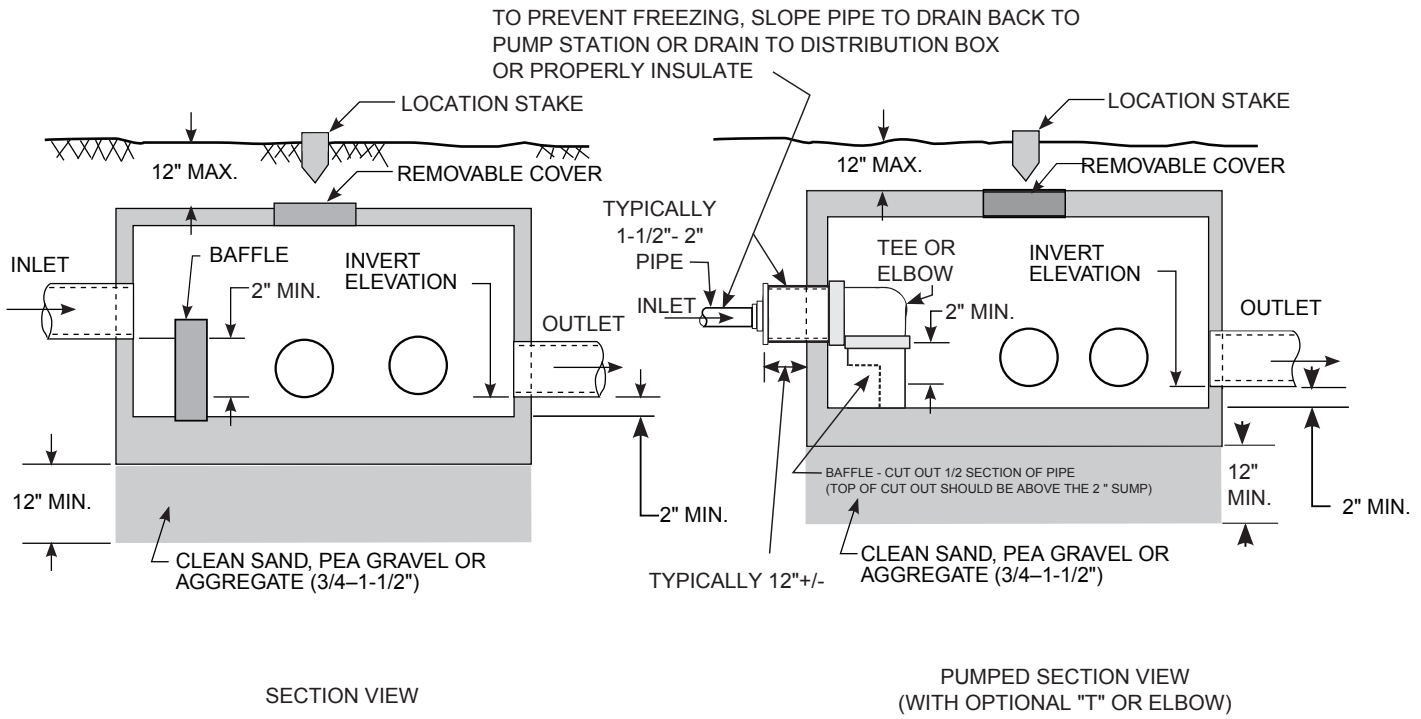

NOTE:
 BAFFLE MAY BE REPLACED BY A
 PVC TEE ("T") OR ELBOW

FIGURE 10: DISTRIBUTION BOX DETAIL

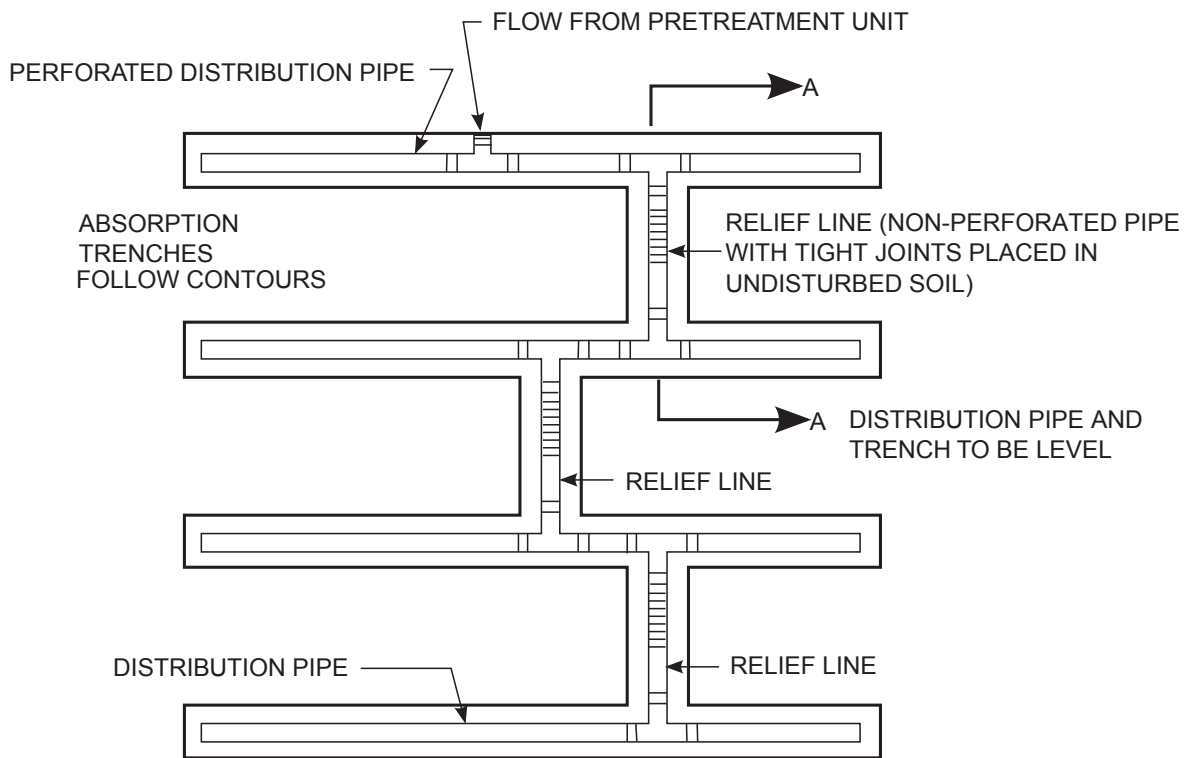

Notes:

1. This method is acceptable for use with dosing systems only.
2. Trenches should be stretched along the contour as long as possible. (minimize number of consecutive trenches down gradient.)

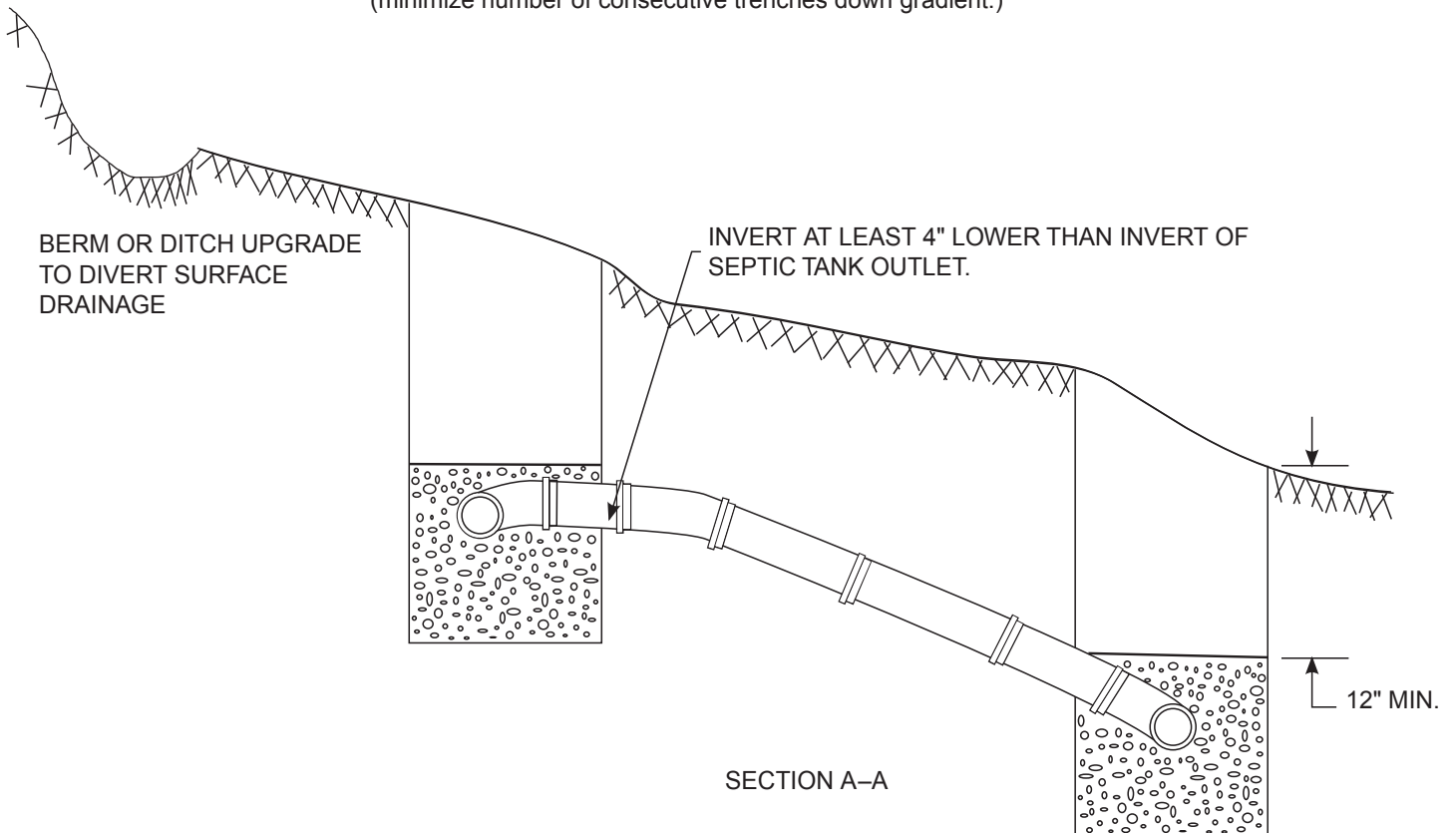

FIGURE 11: SERIAL DISTRIBUTION DETAIL

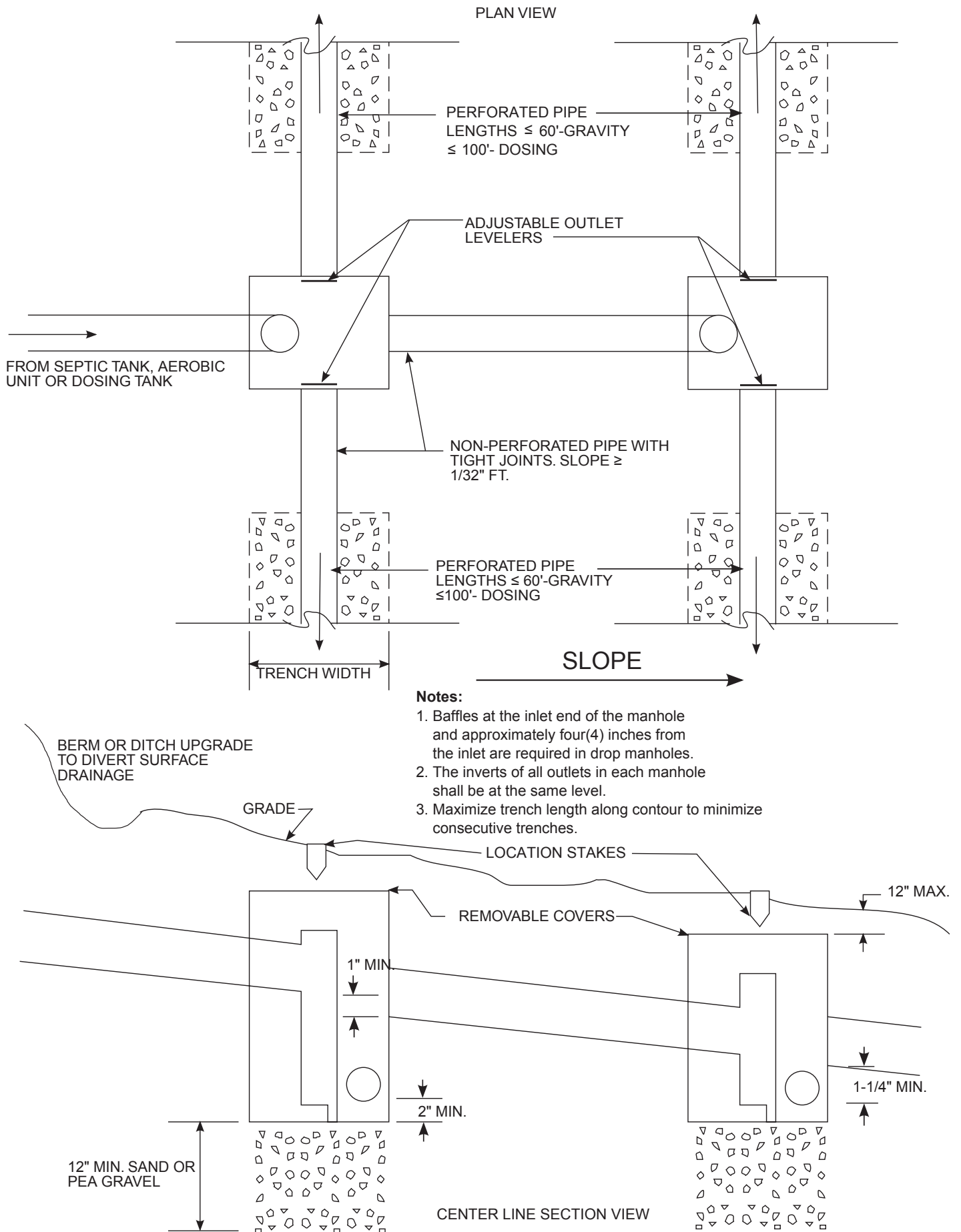

FIGURE 12 : DROP BOX DETAIL

NOTES:

1. Dosing is recommended for all systems as it promotes better treatment of wastewater and system longevity.
2. The use of manually operated siphons or pumps is not acceptable.
3. The volume of effluent in each dose should be 75% to 85% of the volume in the pipe network.
4. Siphon chamber shall be equipped with an audible/visual alarm to indicate malfunction. Alarm should be in an accessible and conspicuous location in the home.
5. Pipe for siphon dosing is sized to conform with the volume of the dose and can range from three (3) to six (6) inches.

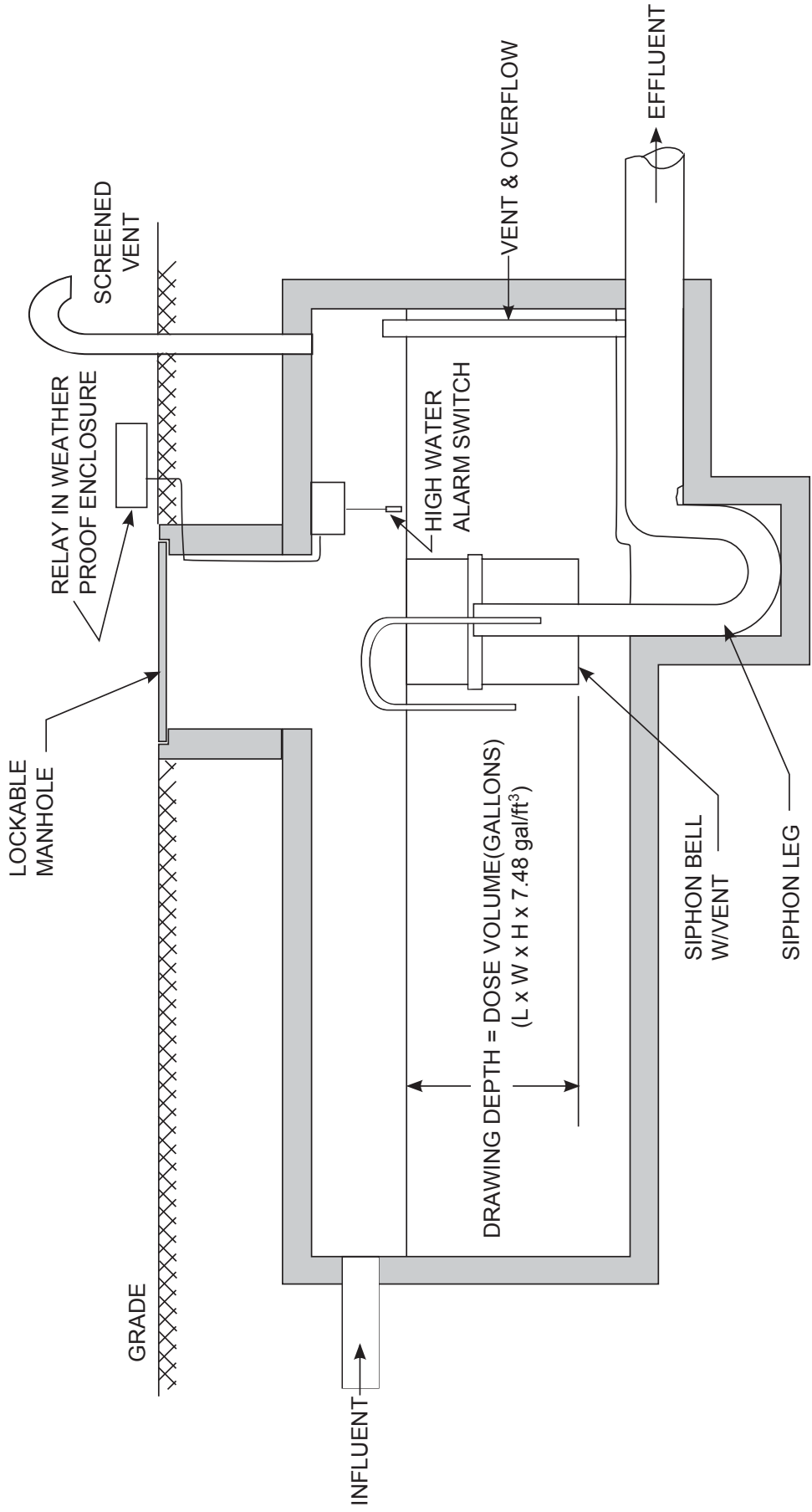

FIGURE 13: TYPICAL DOSING CHAMBER WITH SIPHON

NOTES:

1. Pump chambers shall be sized to provide a minimum of one day's design flow storage above the alarm level or duplex pumping system with audible or visual alarms shall be used in lieu of a single effluent pump and one day's reserve capacity.
2. Pump Chamber shall be equipped with an audible/visual alarm to indicate malfunction. Alarm should be in an accessible and conspicuous location in the home.
3. The use of manually operated siphons or pumps is not acceptable.

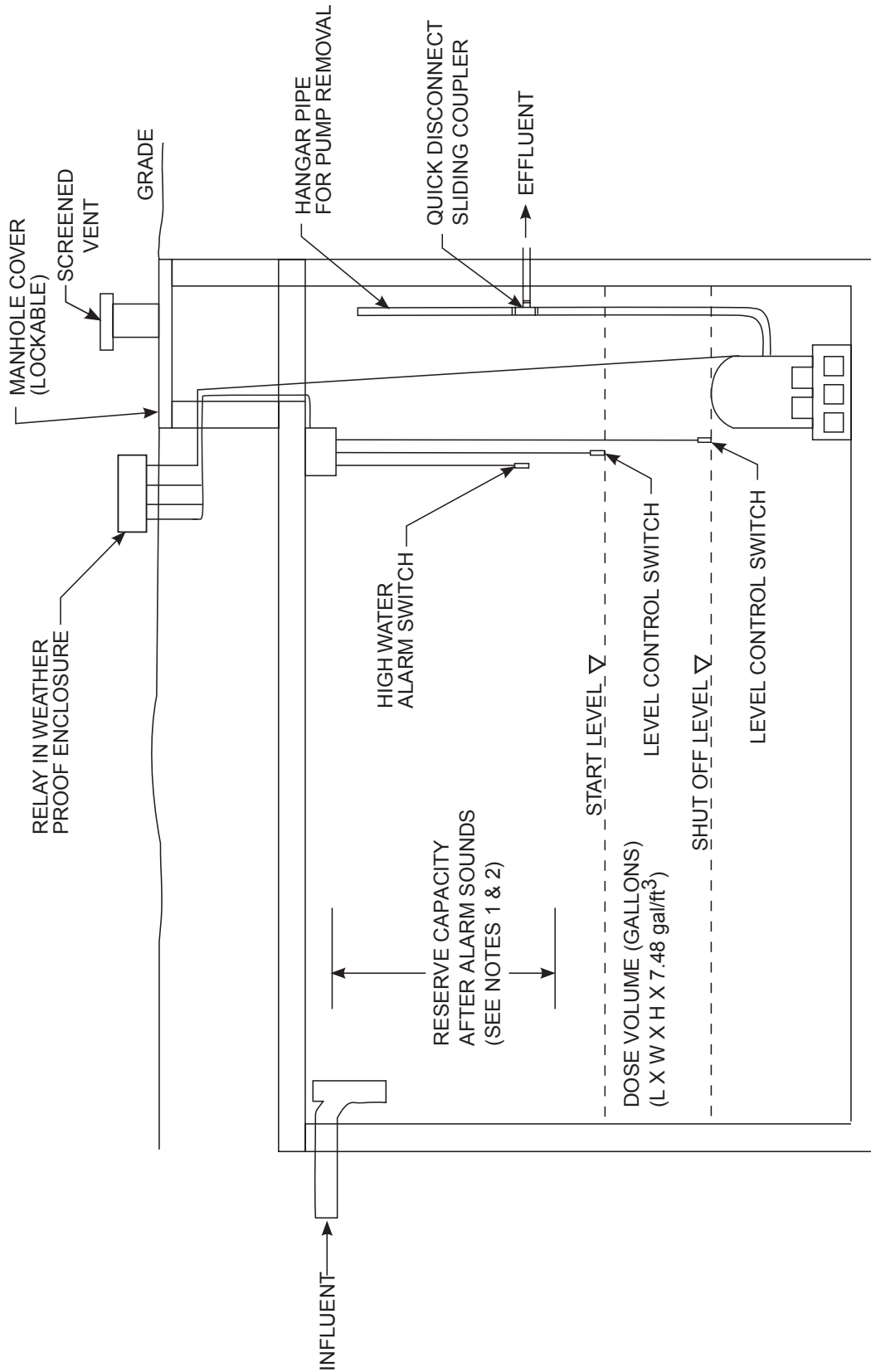

FIGURE 14: TYPICAL DOSING CHAMBER WITH PUMP

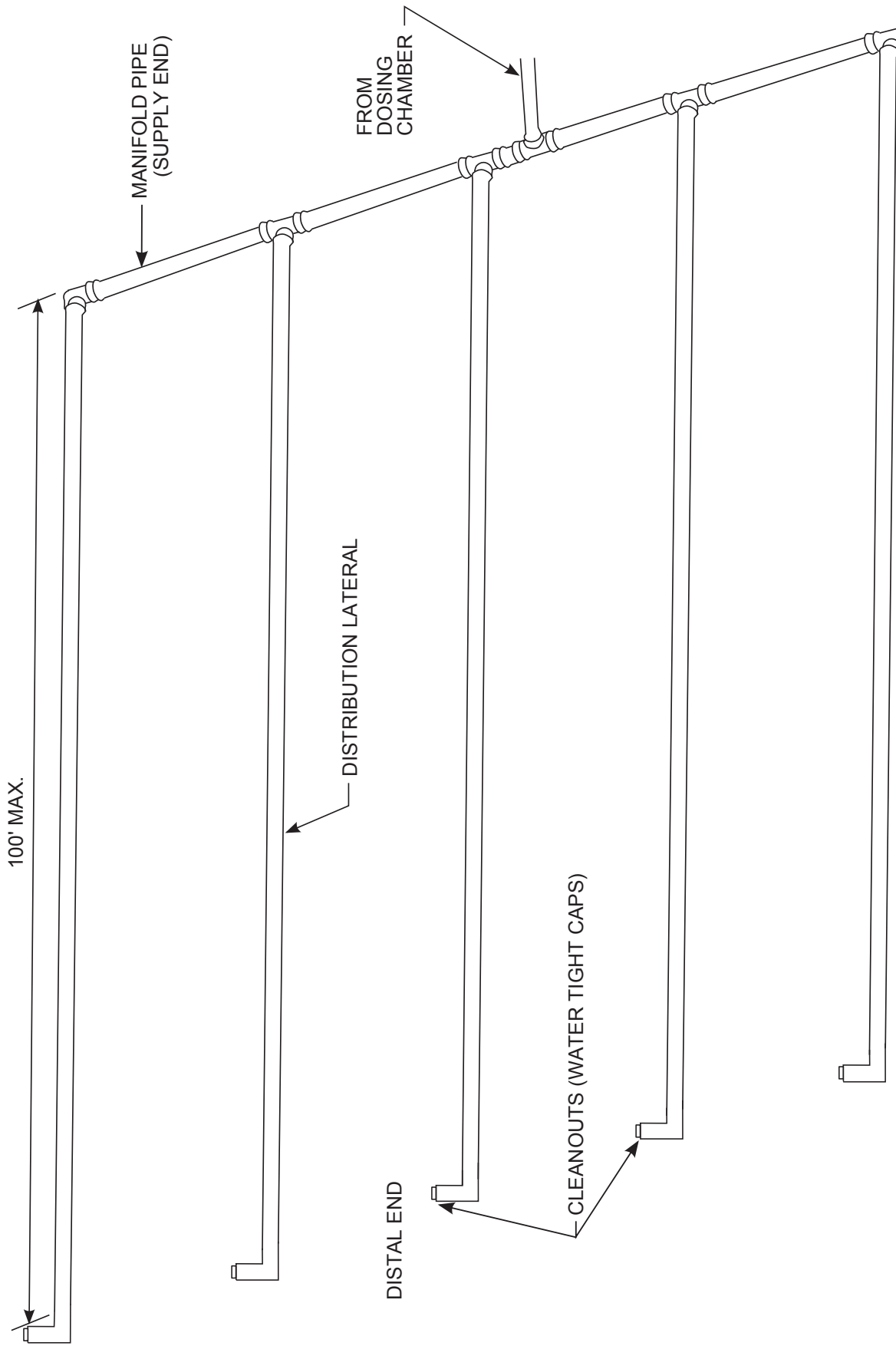

FIGURE 15: END MANIFOLD PRESSURE DISTRIBUTION NETWORK

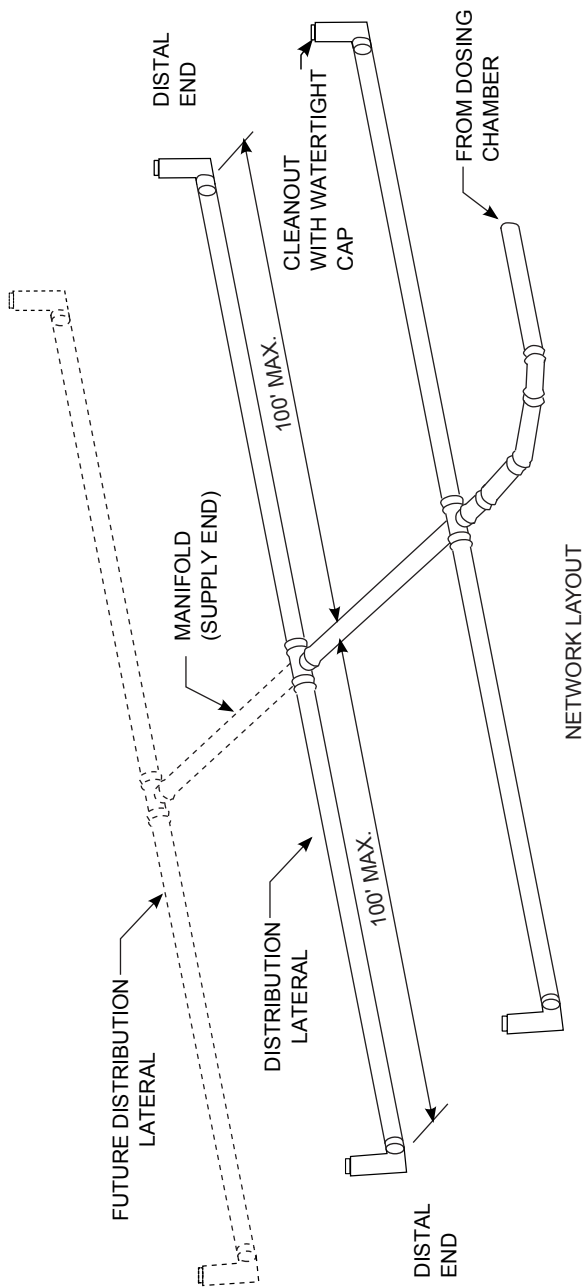
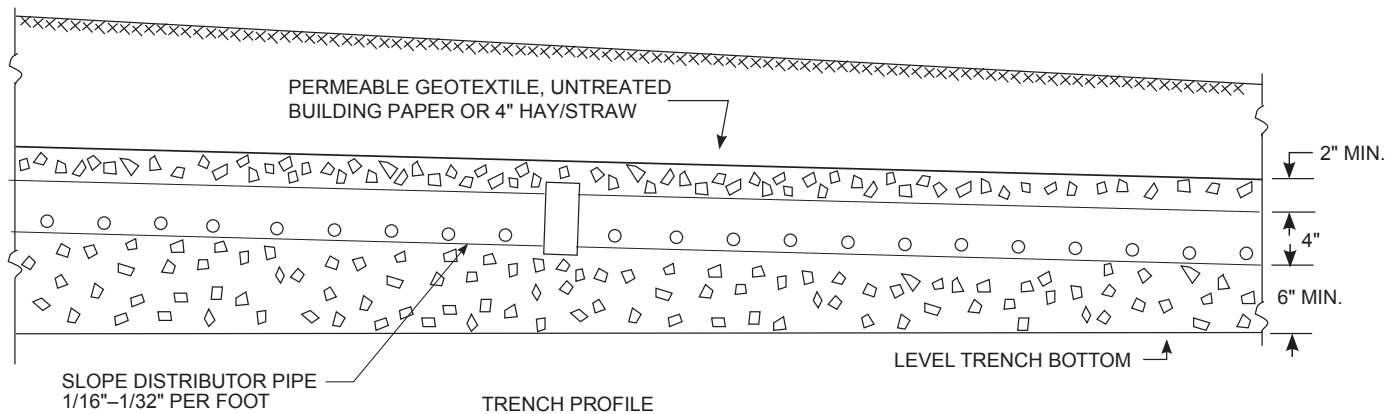
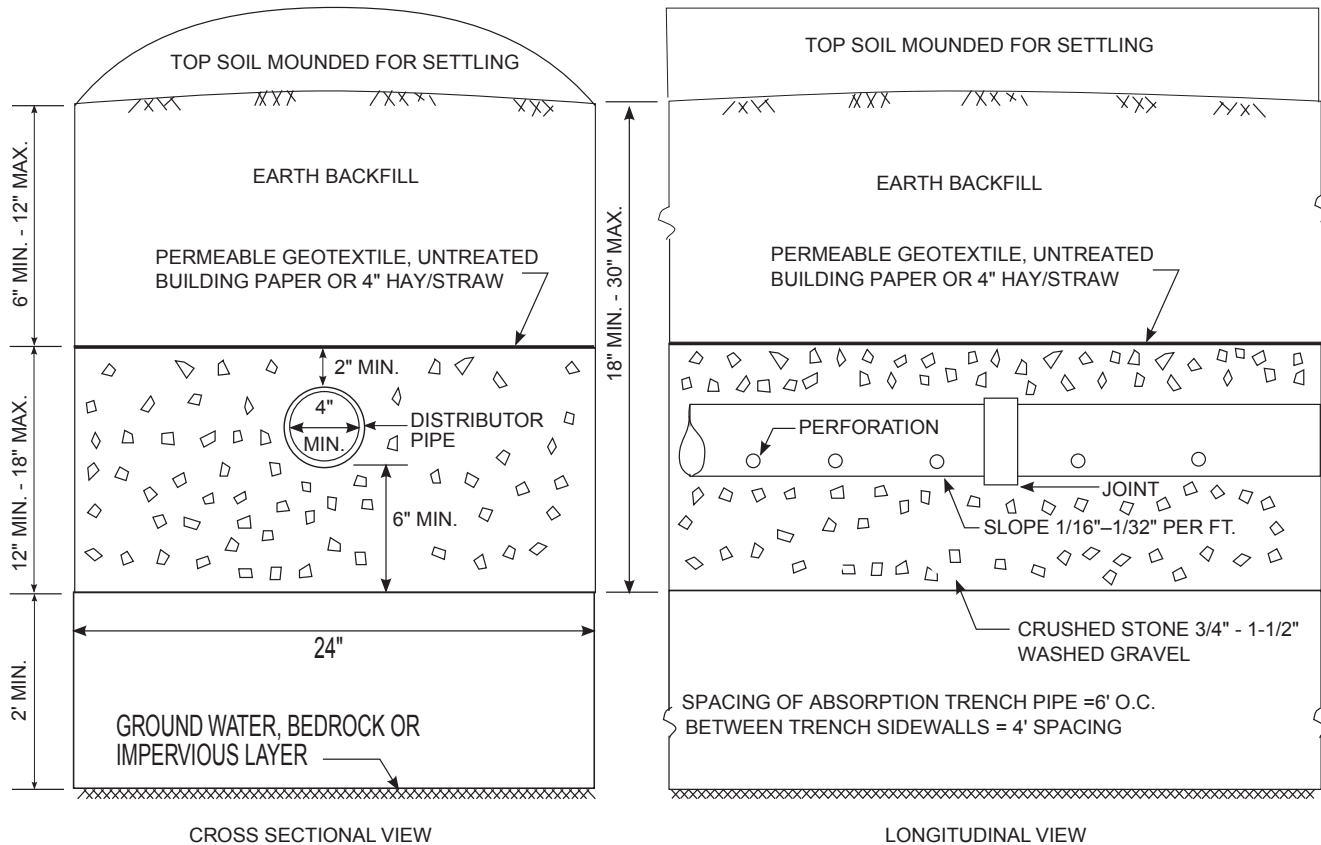

FIGURE 16: CENTRAL MANIFOLD PRESSURE DISTRIBUTION NETWORK



- NOTE:**
1. Do not install trenches in wet soil.
 2. Install trenches parallel to contours.
 3. Install trenches as shallow as possible which meet above noted minimum depths.
 4. Rake sides and bottom of trenches prior to placing gravel.
 5. Ends of all distributor pipes must be capped.
 6. Absorption trench spacing 6' o.c. (4 feet between trench sidewalls).
 7. Maximum depth of trenches is 30 inches.

FIGURE 17: CONVENTIONAL ABSORPTION TRENCH DETAIL

CONVENTIONAL ABSORPTION TRENCH DESIGN

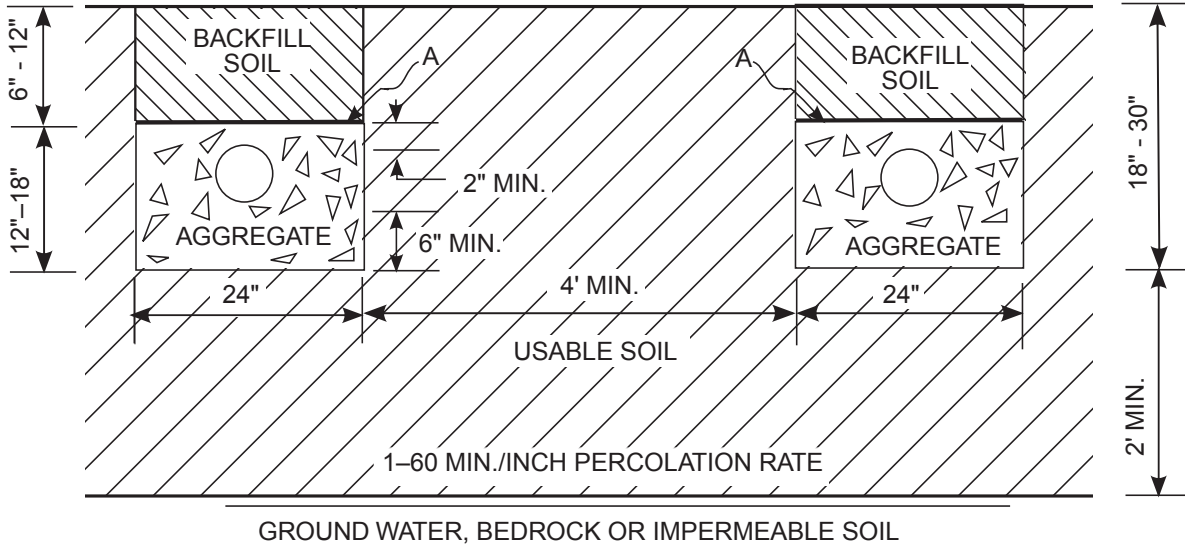

A = PERMEABLE GEOTEXTILE, UNTREATED BUILDING PAPER, OR 4" OF HAY OR STRAW.
 O = LATERAL

15% SLOPE MAX.

ABSORPTION BED DESIGN

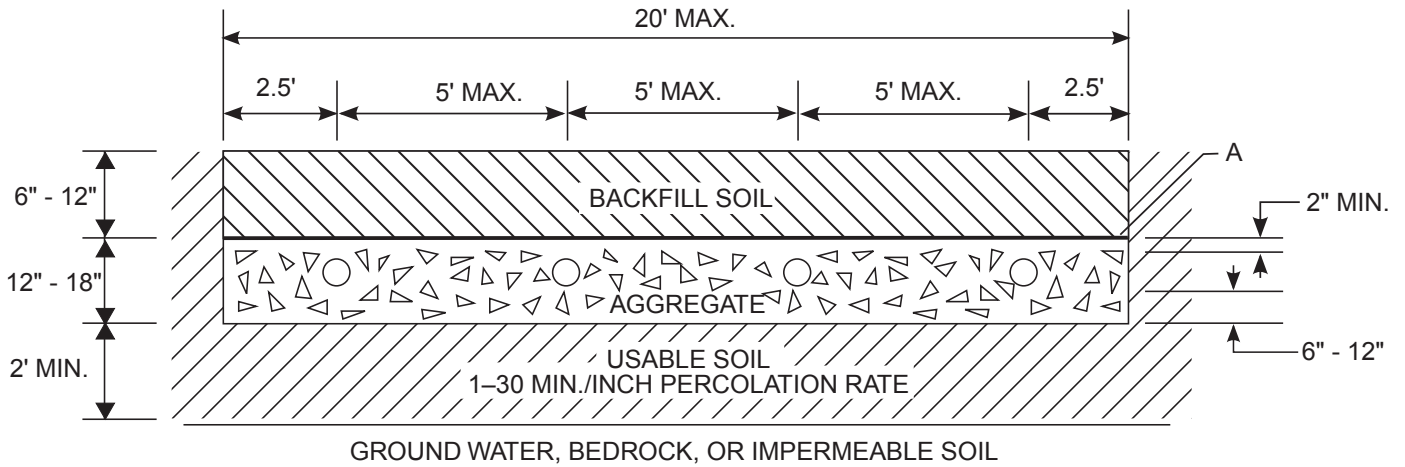

GROUND WATER, BEDROCK, OR IMPERMEABLE SOIL

8% SLOPE MAX.

FIGURE 18: DISTRIBUTION LATERAL SPACING FOR ABSORPTION TRENCH OR BED

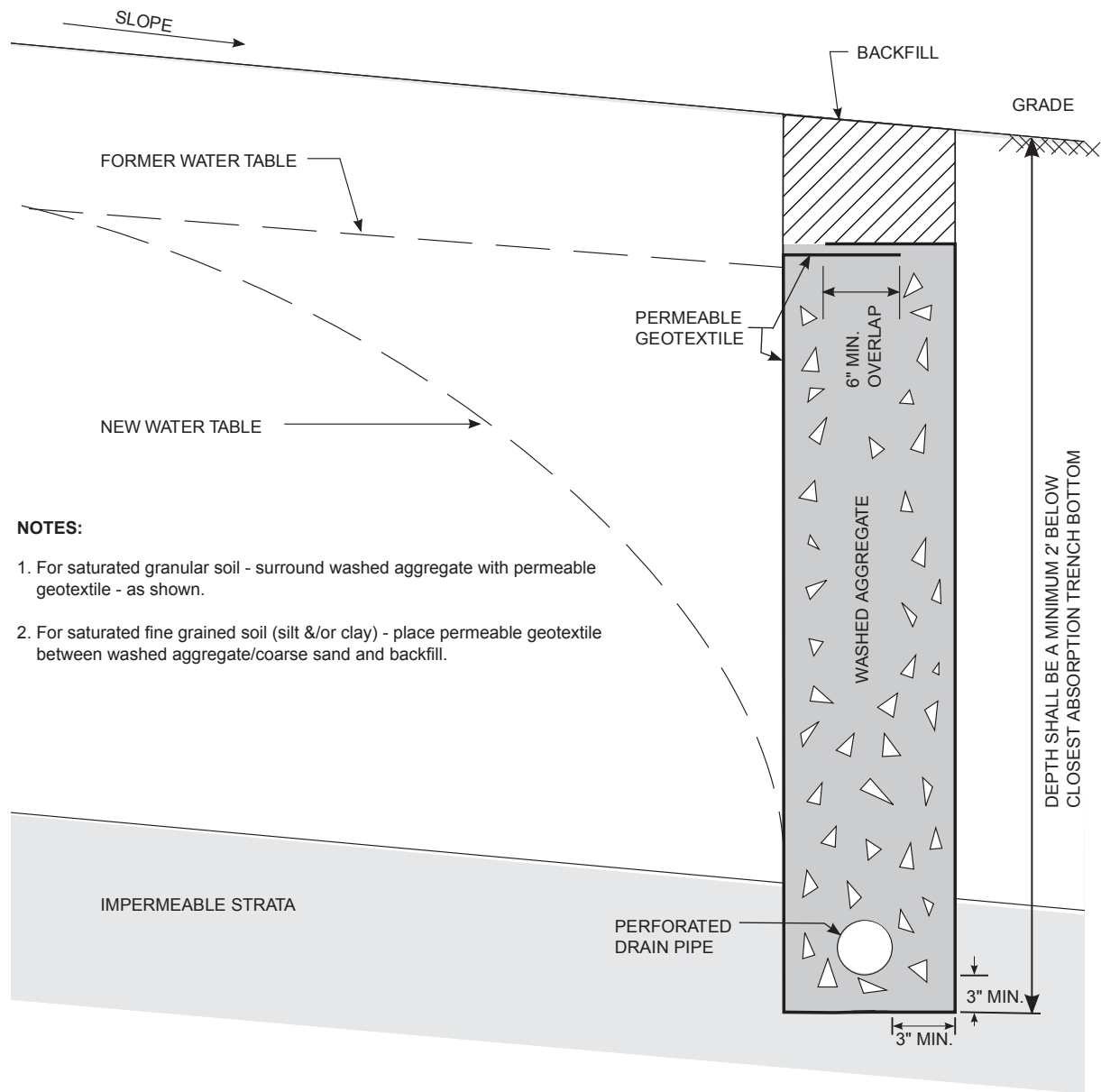
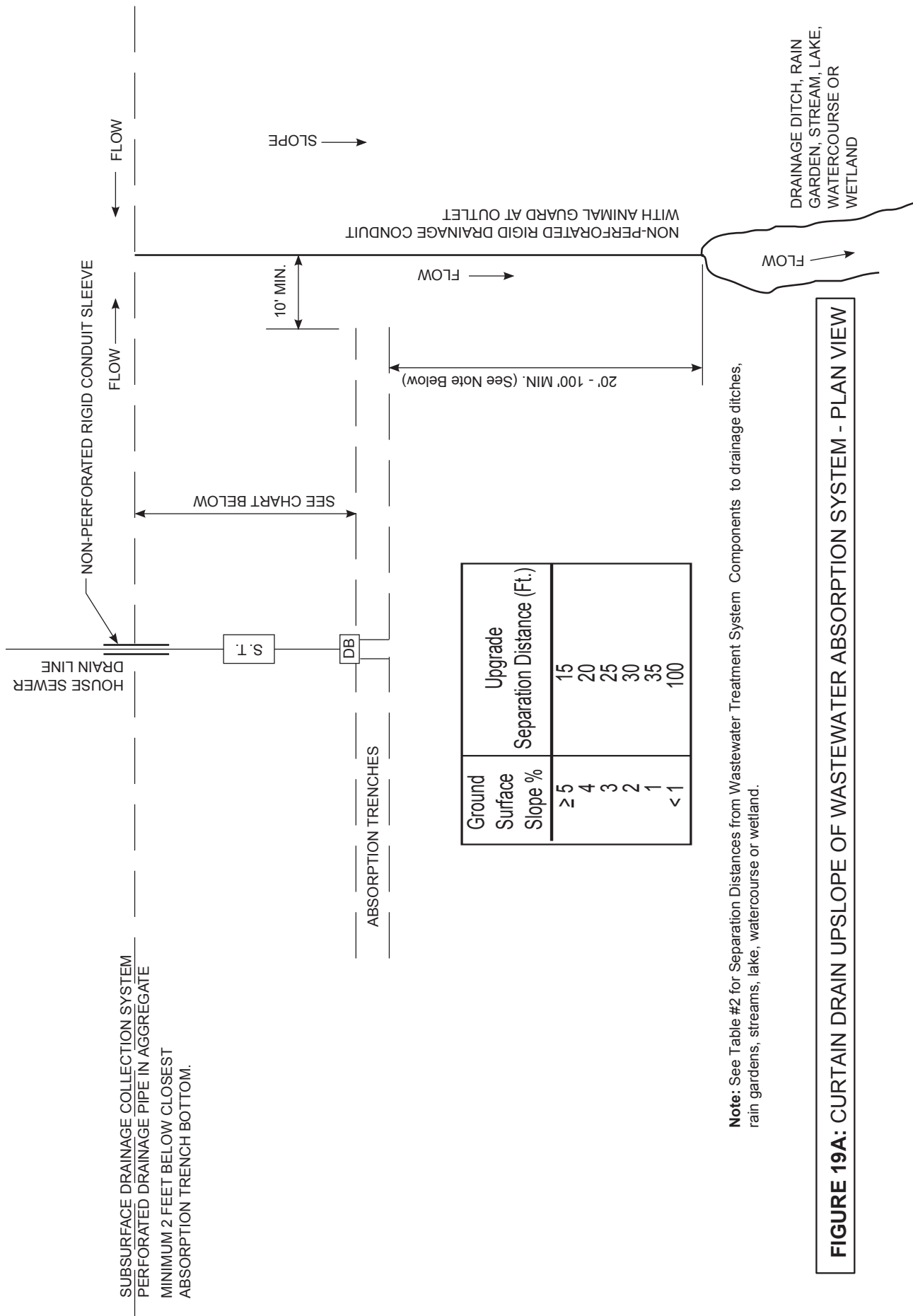
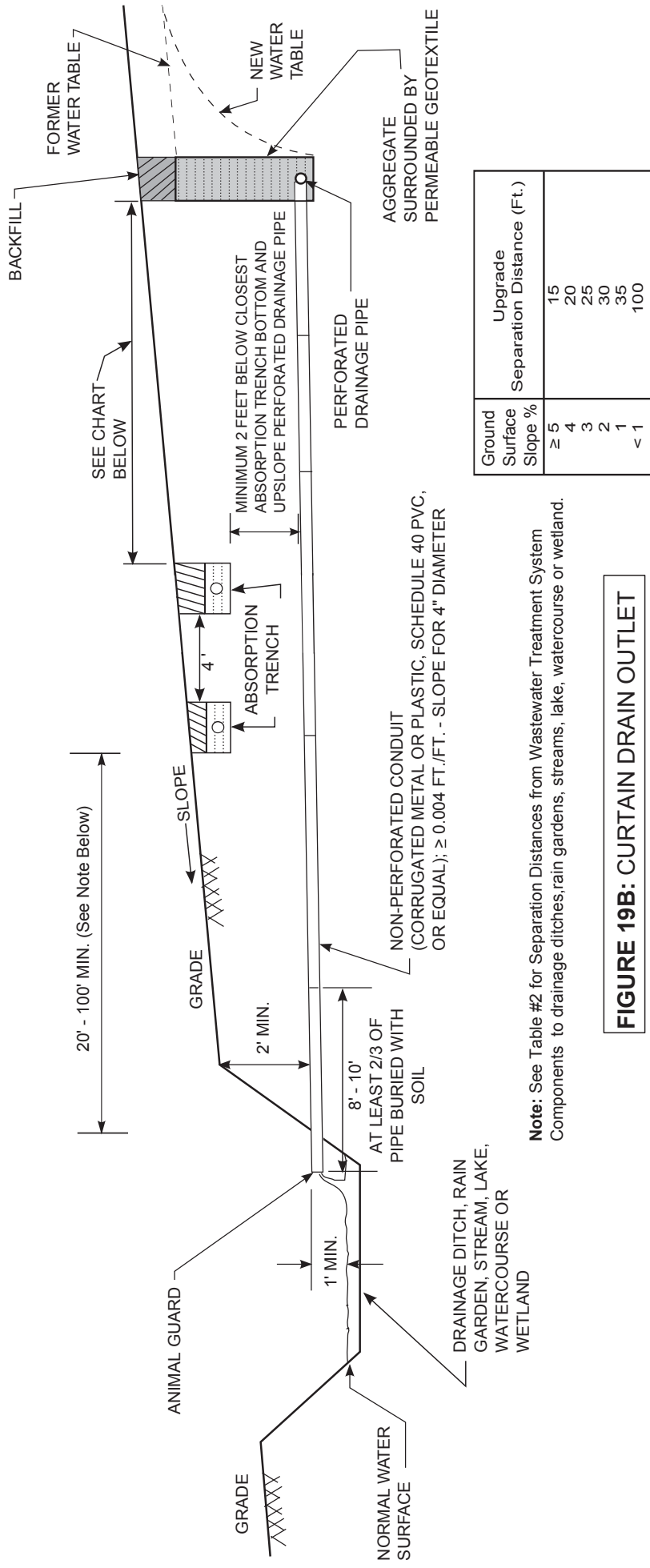

FIGURE 19: CURTAIN DRAIN - CROSS SECTION



Note: See Table #2 for Separation Distances from Wastewater Treatment System Components to drainage ditches, rain gardens, streams, lake, watercourse or wetland.

FIGURE 19A: CURTAIN DRAIN UPSLOPE OF WASTEWATER ABSORPTION SYSTEM - PLAN VIEW



Ground Surface Slope %	Upgrade Separation Distance (Ft.)
≥ 5	15
4	20
3	25
2	30
1	35
< 1	100

Note: See Table #2 for Separation Distances from Wastewater Treatment System Components to drainage ditches, rain gardens, streams, lake, watercourse or wetland.

FIGURE 19B: CURTAIN DRAIN OUTLET

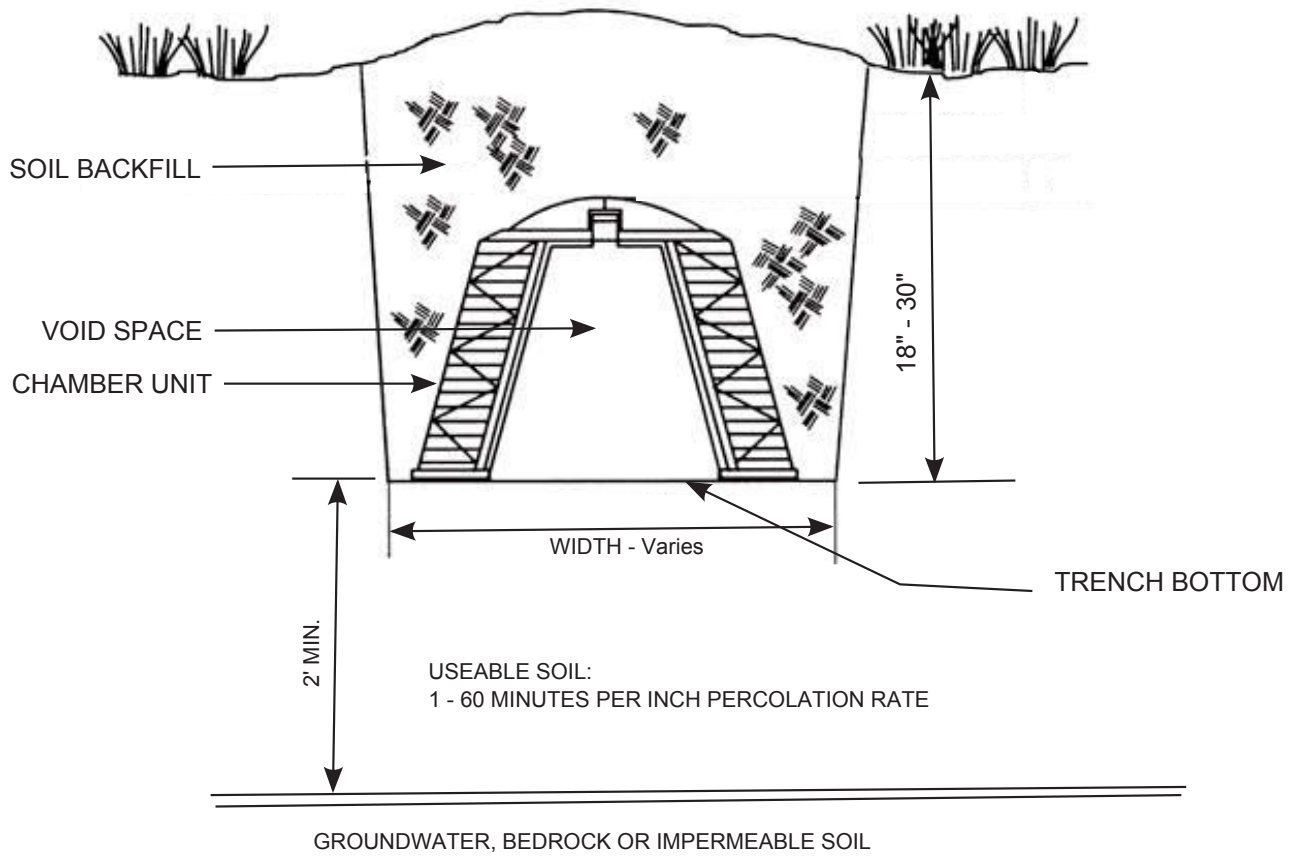

NOTES:

1. Gravelless absorption system products shall be installed in conformance with manufacturer's instructions
2. The gravelless trench sidewalls shall be separated by a minimum of 4 feet.
3. All gravelless trenches shall be of equal length.

FIGURE 20: EXAMPLE OPEN - BOTTOM GRAVELLESS CHAMBER

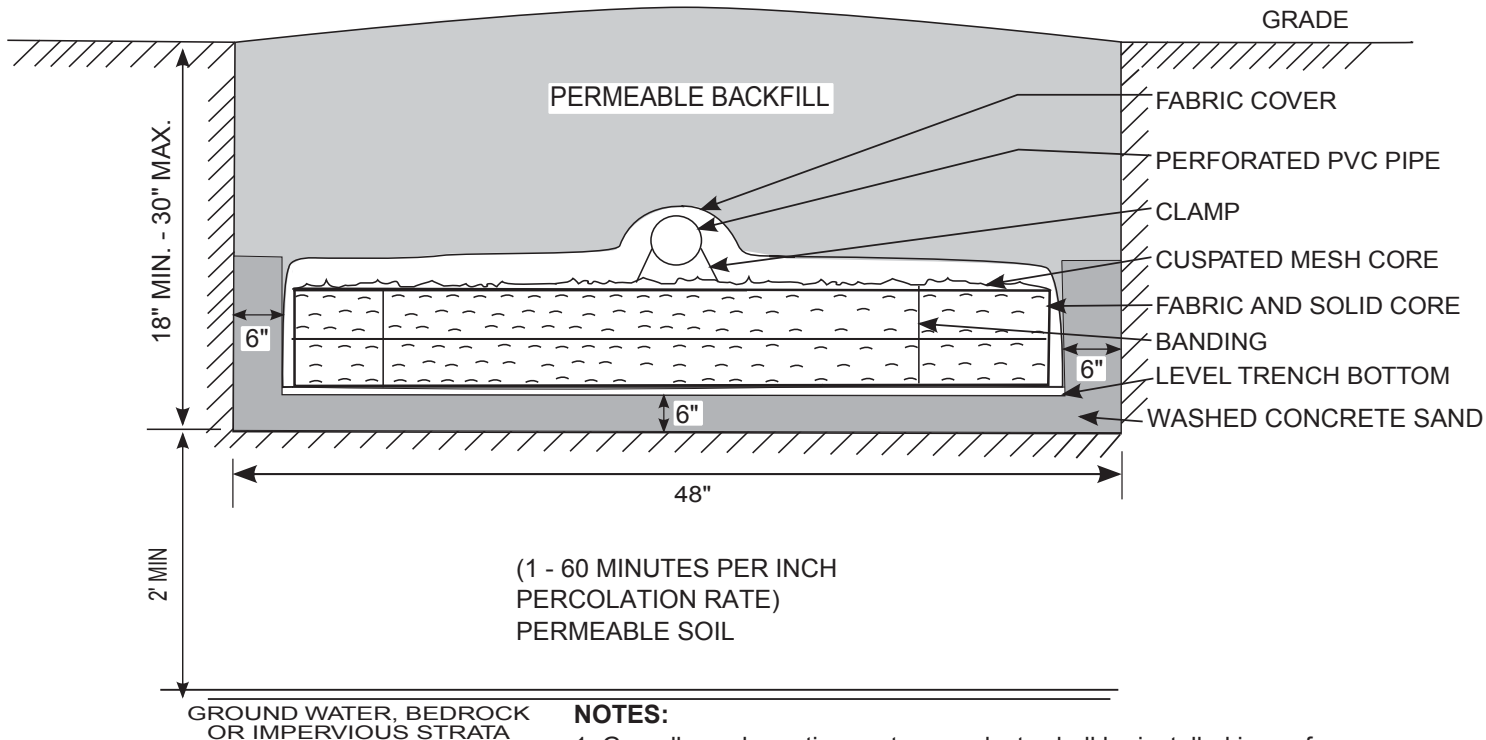

NOTES:

1. Gravelless absorption system products shall be installed in conformance with manufacturer's instructions
2. The gravelless trench sidewalls shall be separated by a minimum of 4 feet of undisturbed soil.
3. All gravelless trenches shall be equal in length.

12" of washed concrete sand between distribution pipes

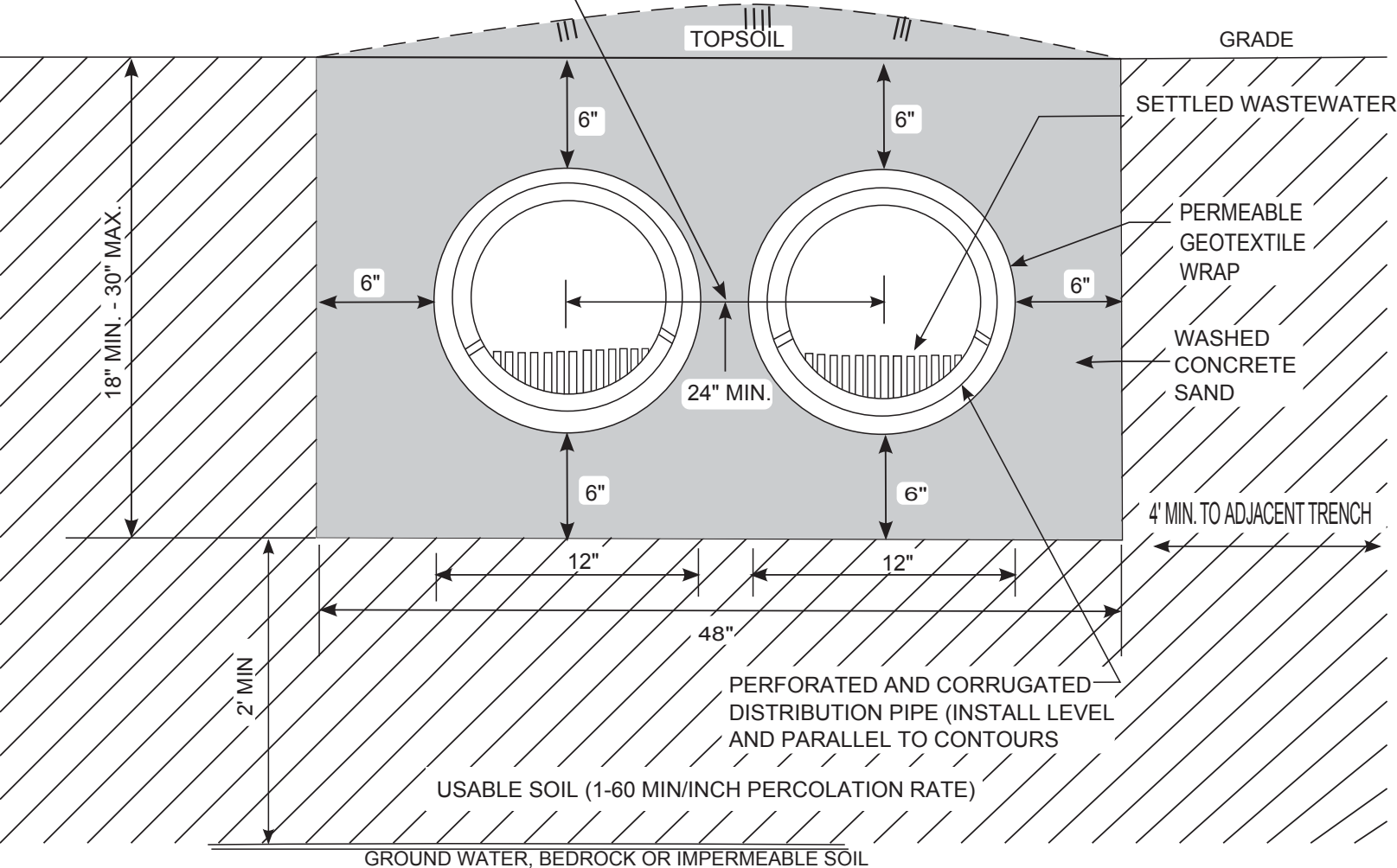
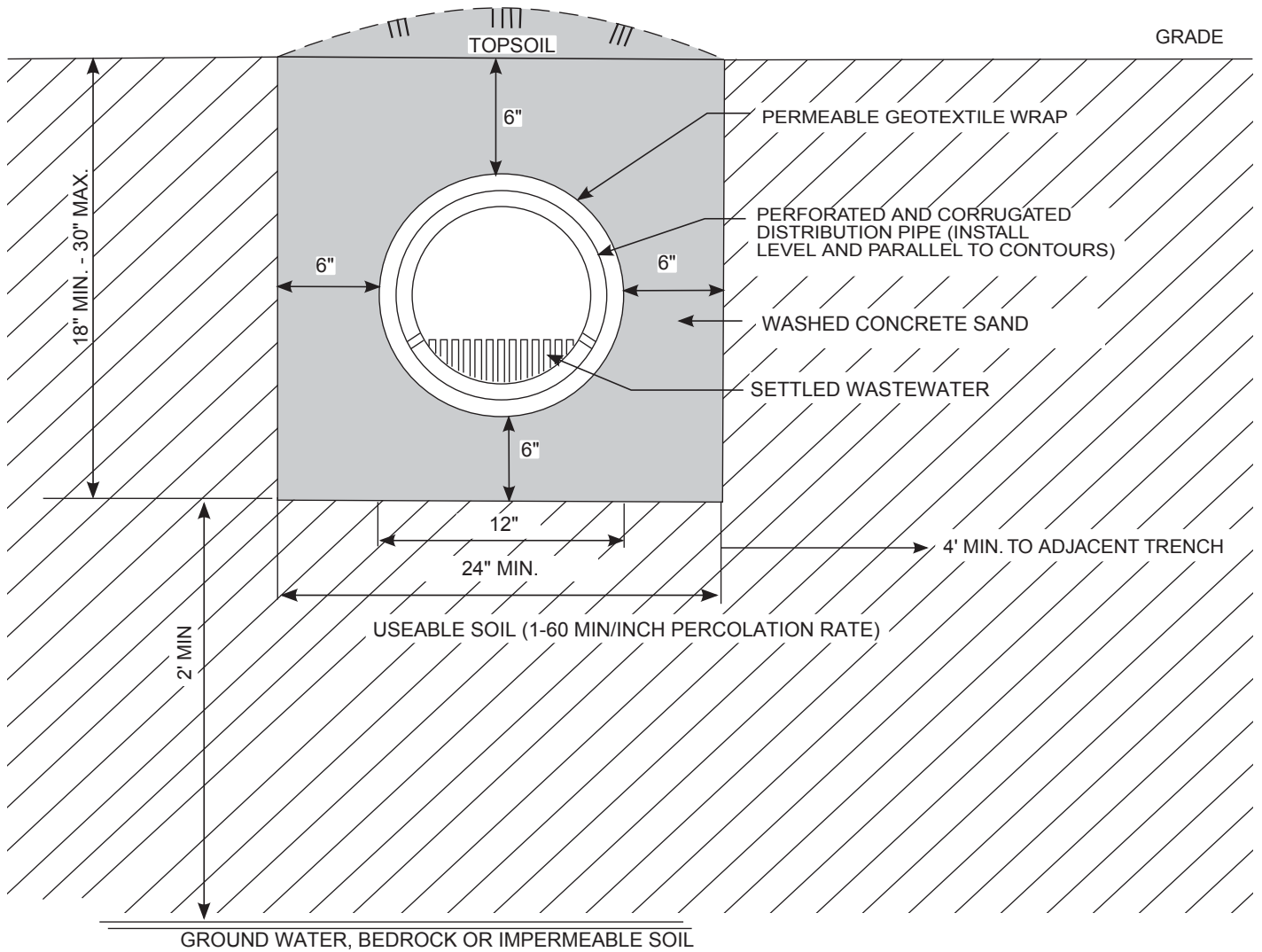

FIGURE 21: TYPICAL GRAVELLESS GEOTEXTILE SAND FILTER SYSTEMS



NOTES:

1. Gravelless absorption system products shall be installed in conformance with manufacturer's instructions
2. The gravelless trench sidewalls shall be separated by a minimum of 4 feet.
3. All gravelless trenches shall be equal in length.

FIGURE 22: EXAMPLE GRAVELLESS MEDIA - WRAPPED CORRUGATED PIPE SAND - LINED SYSTEMS

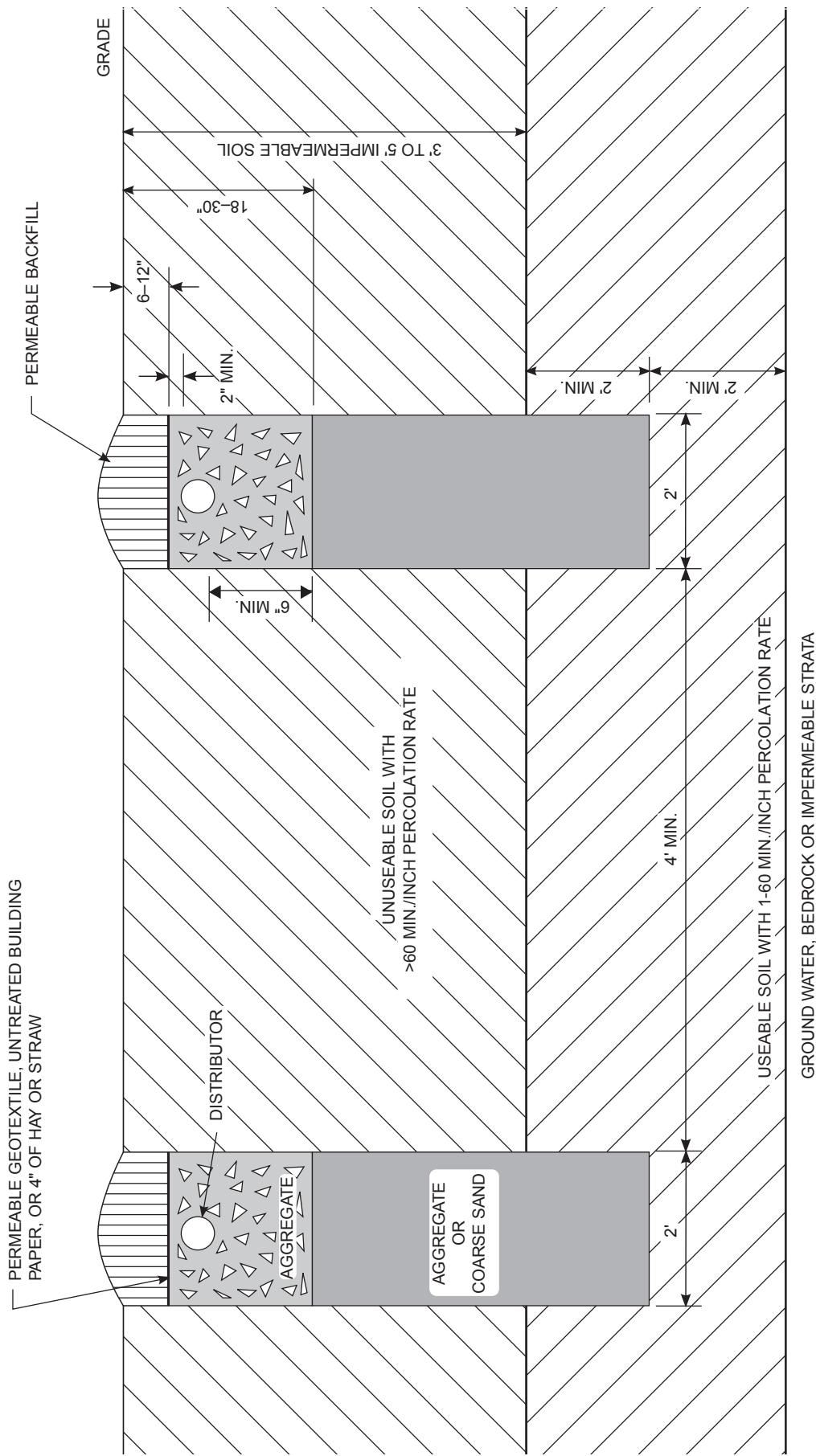

- NOTES:**
1. There shall be at least four (4) feet of useable soil beneath the impermeable layer.
 2. The required length of absorption trench is determined from table 6A or 6B based upon percolation tests conducted in the useable soil.
 3. On sloped sites, a diversion ditch shall be constructed uphill from the trench area to prevent surface runoff from entering the trenches.
 4. Trench bottoms shall be level. Trenches shall be parallel to ground contours.
 5. Coarse sand top shall be level.
 6. Distributors shall slope 1/16 to 1/32 inch per foot.

FIGURE 23: DEEP ABSORPTION TRENCHES

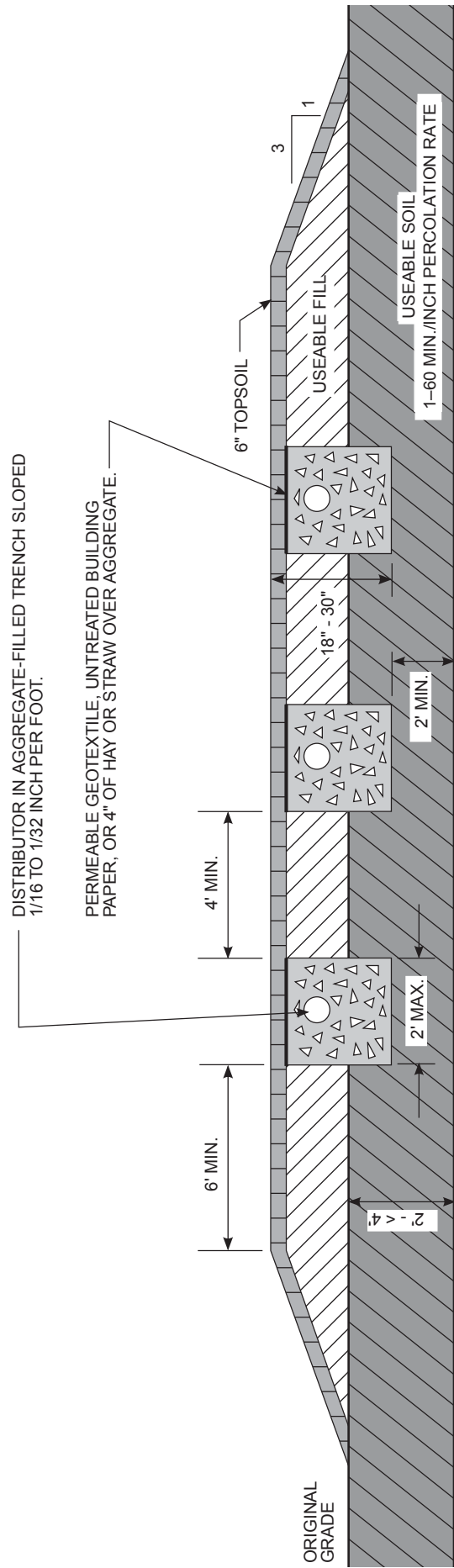

- NOTES:**
1. Bottom of all trenches shall not be above original useable soil and should preferably be at least 6" below original grade.
 2. Useable fill should have a percolation rate similar to but not faster than the useable soil percolation rate.
 3. Maximum depth of useable fill plus six (6) inches of topsoil shall not exceed 30 inches.
 4. Trench bottoms shall be level. Trenches shall be parallel to ground contours.
 5. On sloped sites, a diversion ditch shall be constructed uphill from the fill to prevent surface runoff from entering the fill.
 6. Extend fill at least six (6) feet beyond ends of trenches before starting 1 on 3 edges of fill.
 7. Heavy equipment shall be kept out of the absorption area.
 8. Fill material is carefully placed within the absorption area.

FIGURE 24: SHALLOW ABSORPTION TRENCH SYSTEM - END VIEW

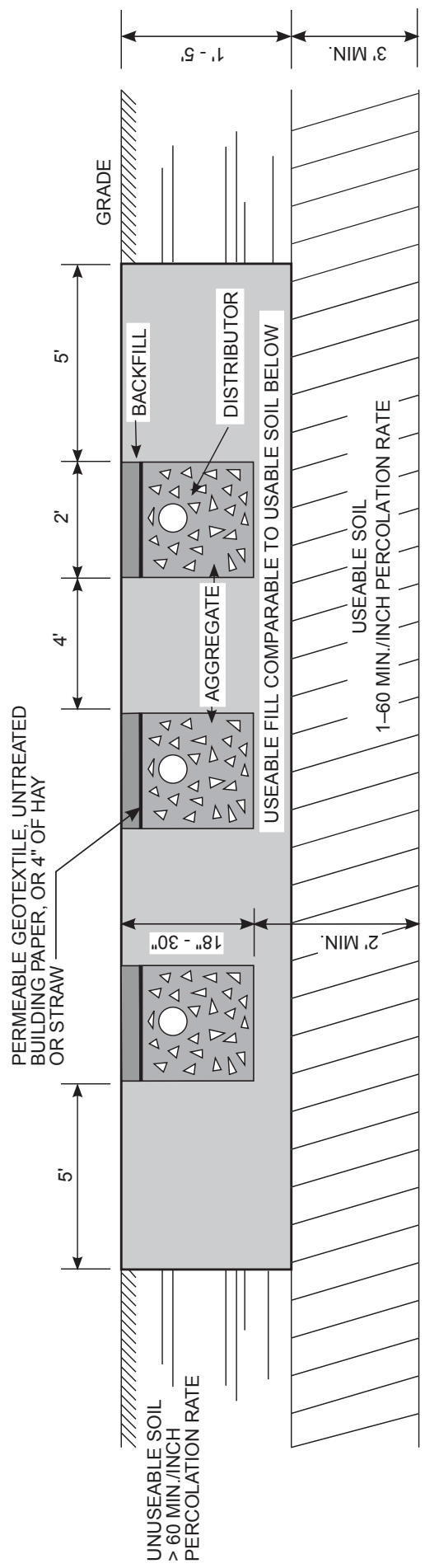

GROUND WATER, BEDROCK, OR IMPERMEABLE STRATA

- NOTES:**
1. On sloped sites, a diversion ditch shall be constructed uphill from the fill and trench area to prevent surface runoff from entering the absorption area.
 2. A Soil Layer with a percolation rate slower than 60 minutes per inch, such as clay or clay loam, overlays a useable soil with a percolation rate faster than 60 minutes per inch.
 3. At least three (3) feet of useable soil is available beneath the unuseable soil.
 4. All minimum vertical and horizontal separation distances can be maintained as described in table 2.
 5. It shall provide for the removal of the overlying unuseable soil and replacement by soil having a percolation rate comparable with the underlying soil.
 6. The required length of absorption trench is based upon the percolation of the underlying soil or the fill material, whichever has the slower percolation (lower permeability).
 7. The area excavated and filled must provide at least a five (5) foot buffer in each direction beyond the trenches
 8. Original unuseable soil shall not be used as backfill above the trenches.

FIGURE 25: CUT AND FILL SYSTEM

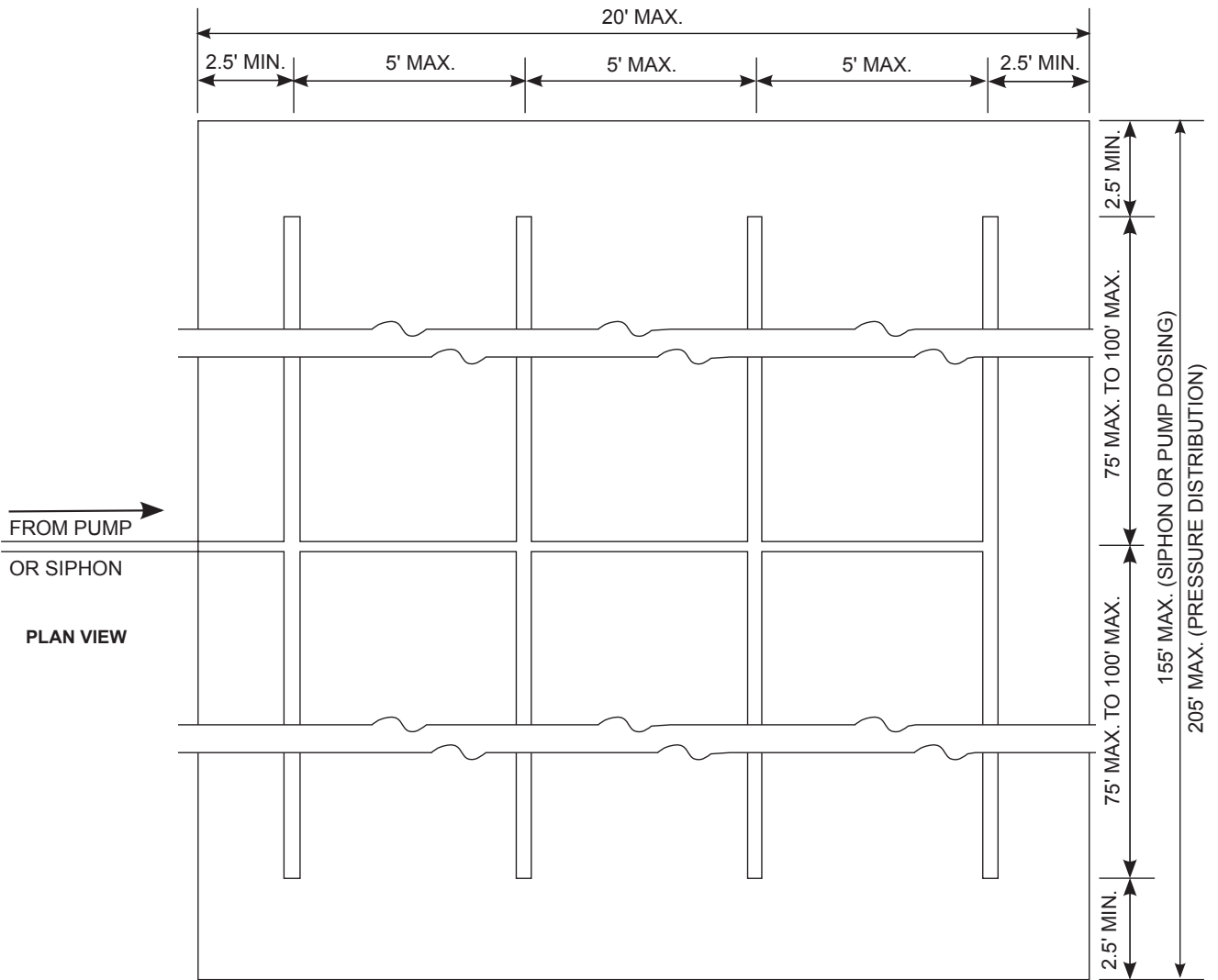

- NOTES:**
1. A bed system may be built in soils with a percolation rate between one (1) and 30 minutes per inch.
 2. A bed shall not be built where the soil evaluation indicates silty loam, clay loam, or clay.
 3. Slope of site shall not exceed eight (8) percent.
 4. Bed systems are more practical on sites that are long and narrow with a minimal slope.
 5. Pressure distribution is required for the installation of an absorption bed system.
 6. The local authority having jurisdiction may allow the use of siphon dosing on specific sites.
 7. Distributor laterals and bed bottom shall be level.
 8. The required bed bottom area shall be calculated from the application rates shown in table 7A or 7B.

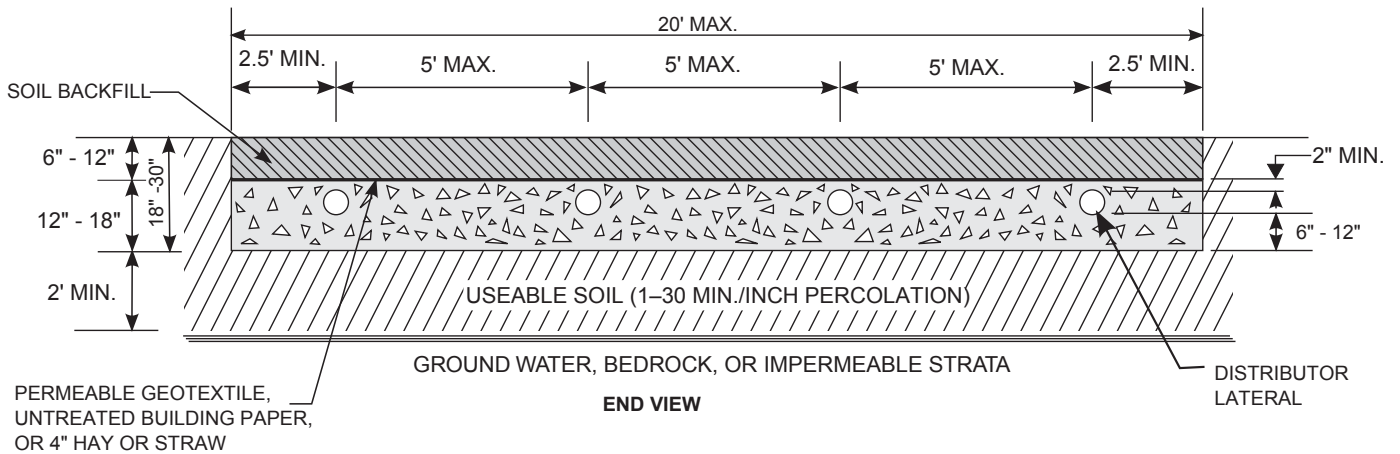

FIGURE 26: ABSORPTION BED SYSTEM

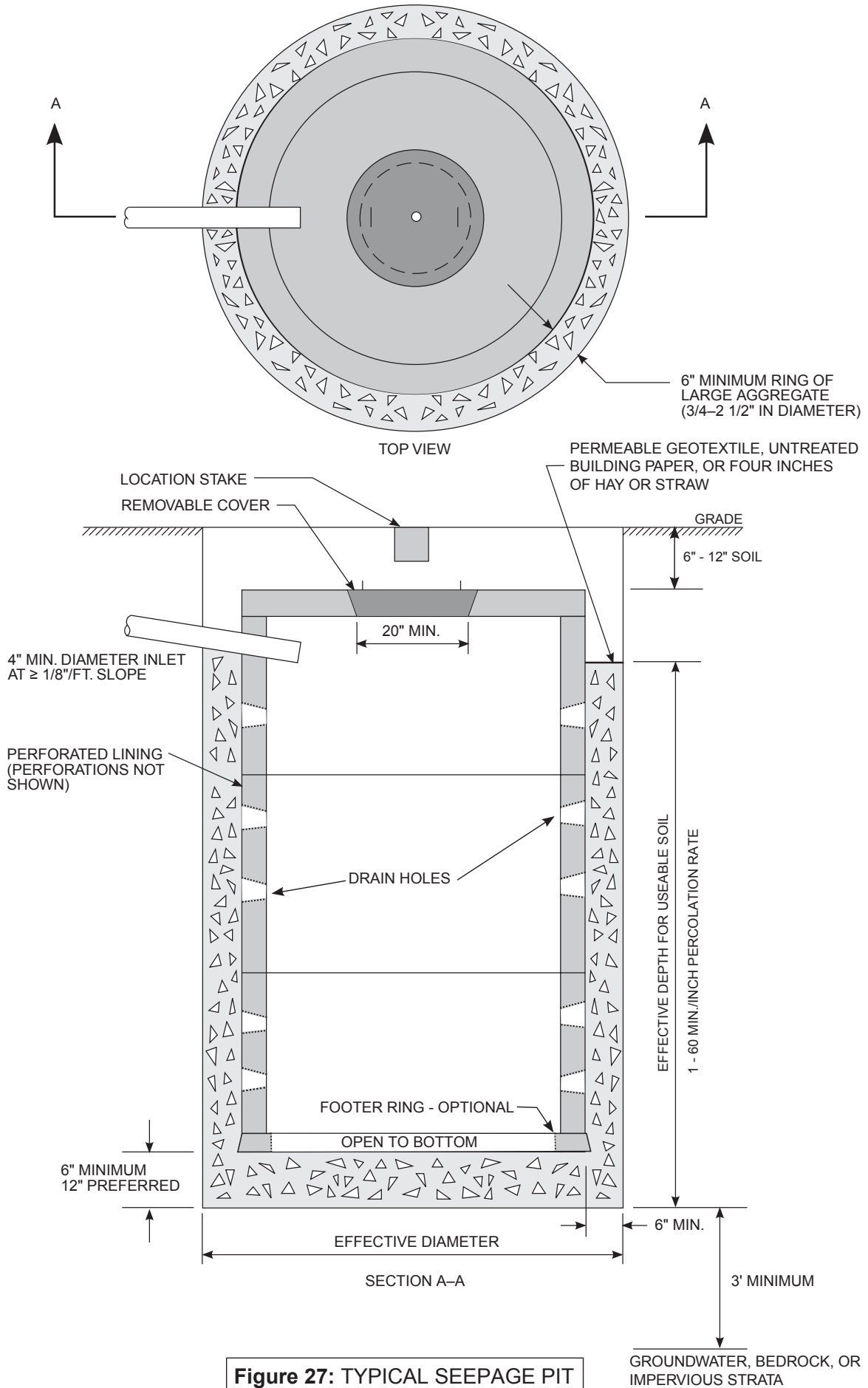
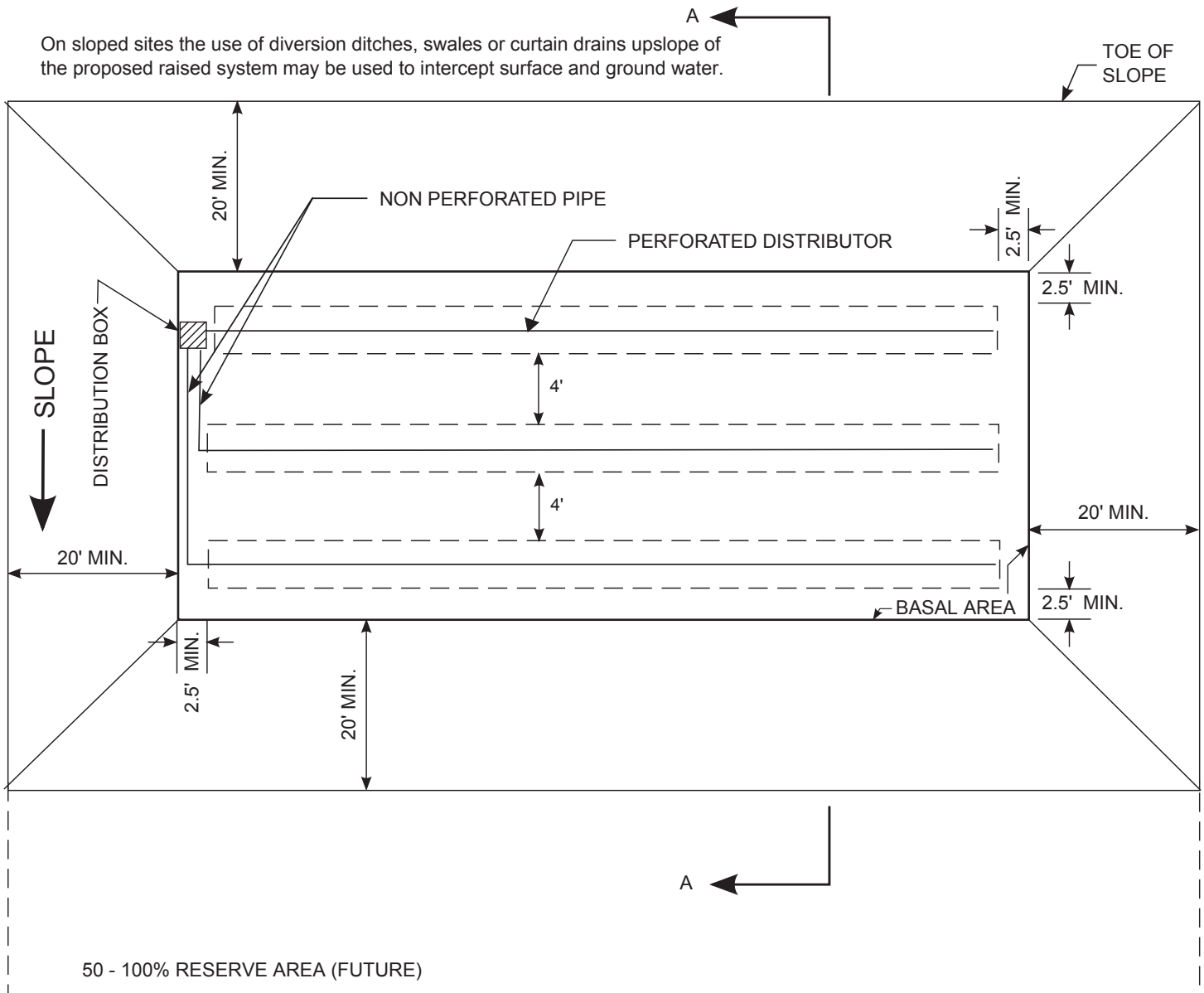
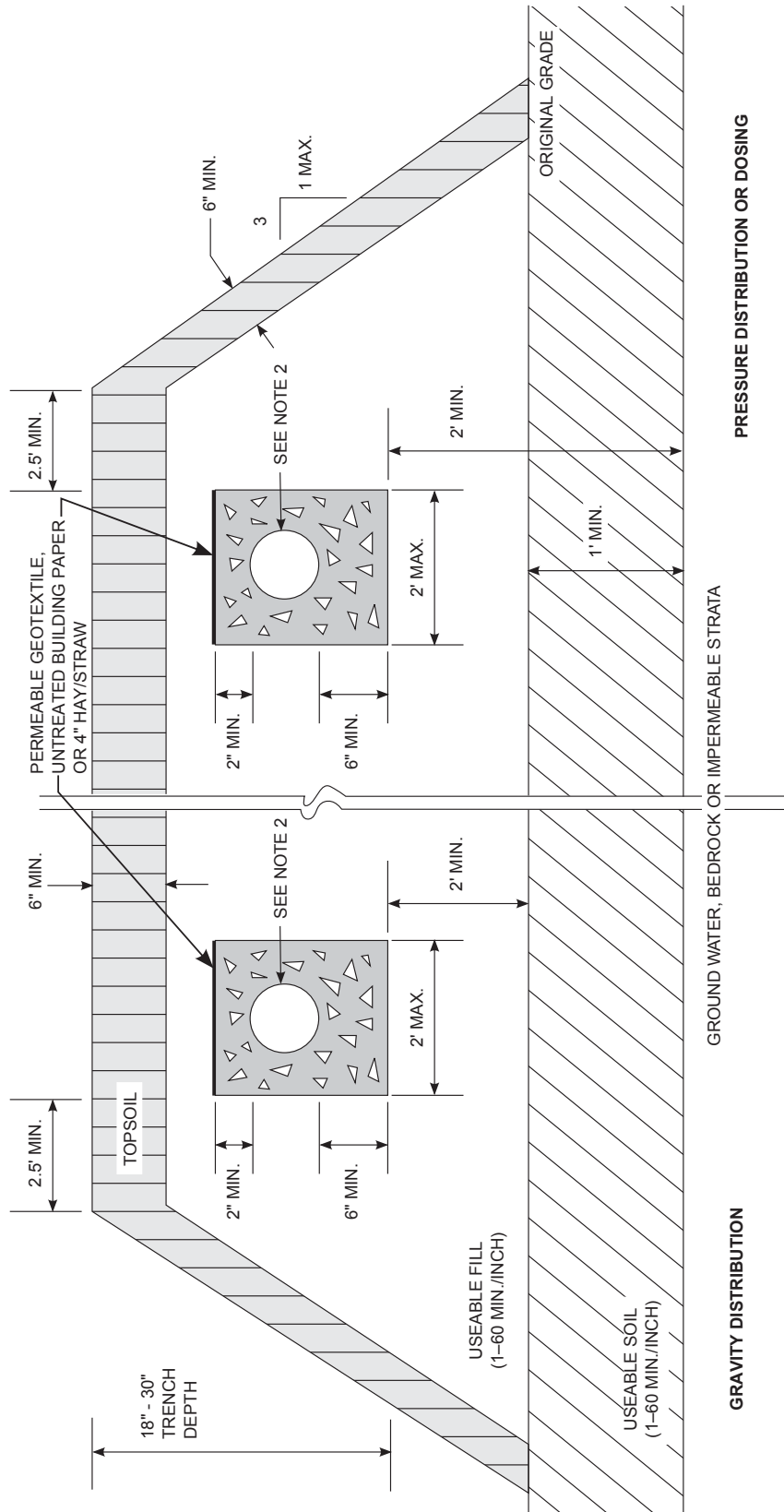

Figure 27: TYPICAL SEEPAGE PIT



- NOTES:**
1. There is at least one foot of original soil with faster than 60 minutes percolation rate, above any impermeable soil layer or bedrock, but not more than two feet.
 2. The maximum high groundwater level must be at least one foot below the original ground surface.
 3. Slopes shall not exceed 15%.
 4. Fill material with a percolation rate of between 5 - 30 min/in. with a sand or sandy loam 5 - 10 min/in. preferred.

FIGURE 28: RAISED SYSTEM - TOP VIEW



NOTES:

1. Raised systems shall incorporate an automatic dosing device or pressure distribution. Gravity Distribution may be installed under the jurisdiction of a local health department or other jurisdictional agency with a system design and a construction/inspection certification program.
2. Distribution pipe diameters for dosing shall be in the range of 3 inches to 6 inches maximum. Distribution pipe diameters for pressure distribution shall be in the range of 1 inch minimum to 3 inches maximum. Use 4 inch diameter perforated pipe for gravity distribution.
3. Distance between trenches to be 4 feet minimum edge-to-edge.

FIGURE 29: RAISED SYSTEM - CROSS SECTION FOR GRAVITY DISTRIBUTION, PRESSURE DISTRIBUTION OR DOSING

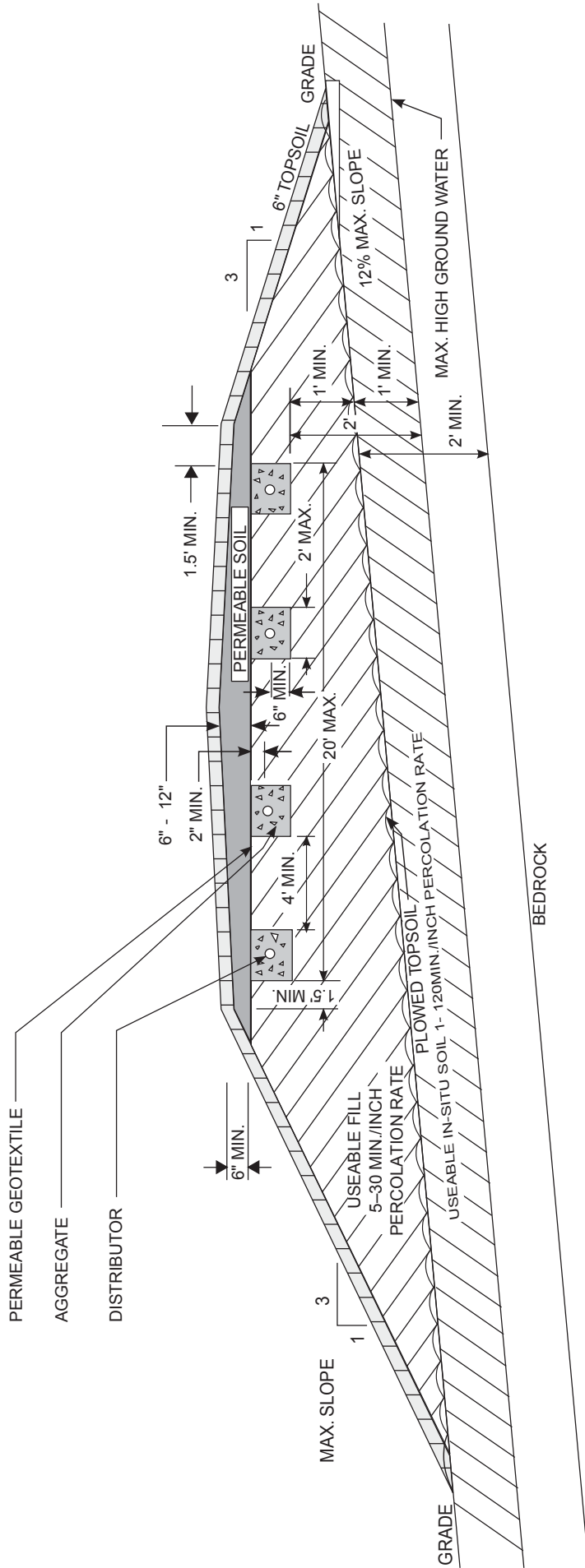

- NOTES:**
1. Only soils with a percolation rate between five (5) and thirty (30) minutes per inch shall be used for the fill material. Sands with greater than 10% by weight finer than 0.05 mm material must be avoided. At least 25% of the material by weight shall be in the range of 0.50 mm to 2.0 mm. Less than 15% of the material by weight shall be larger than a 1/2 inch sieve. A sieve analysis may be necessary to verify this requirement.
 2. Preparation of the site on which the mound is to be located, placement of the fill on the site, construction of the absorption trenches or bed, grading the exposed fill, and grading/seeding the top soil are critical to proper operation of the mound system.
 3. Use Tables 6A or 6B of this handbook for trench lengths based upon fill material percolation rate.

FIGURE 30: TYPICAL MOUND - CROSS SECTION WITH ABSORPTION TRENCHES

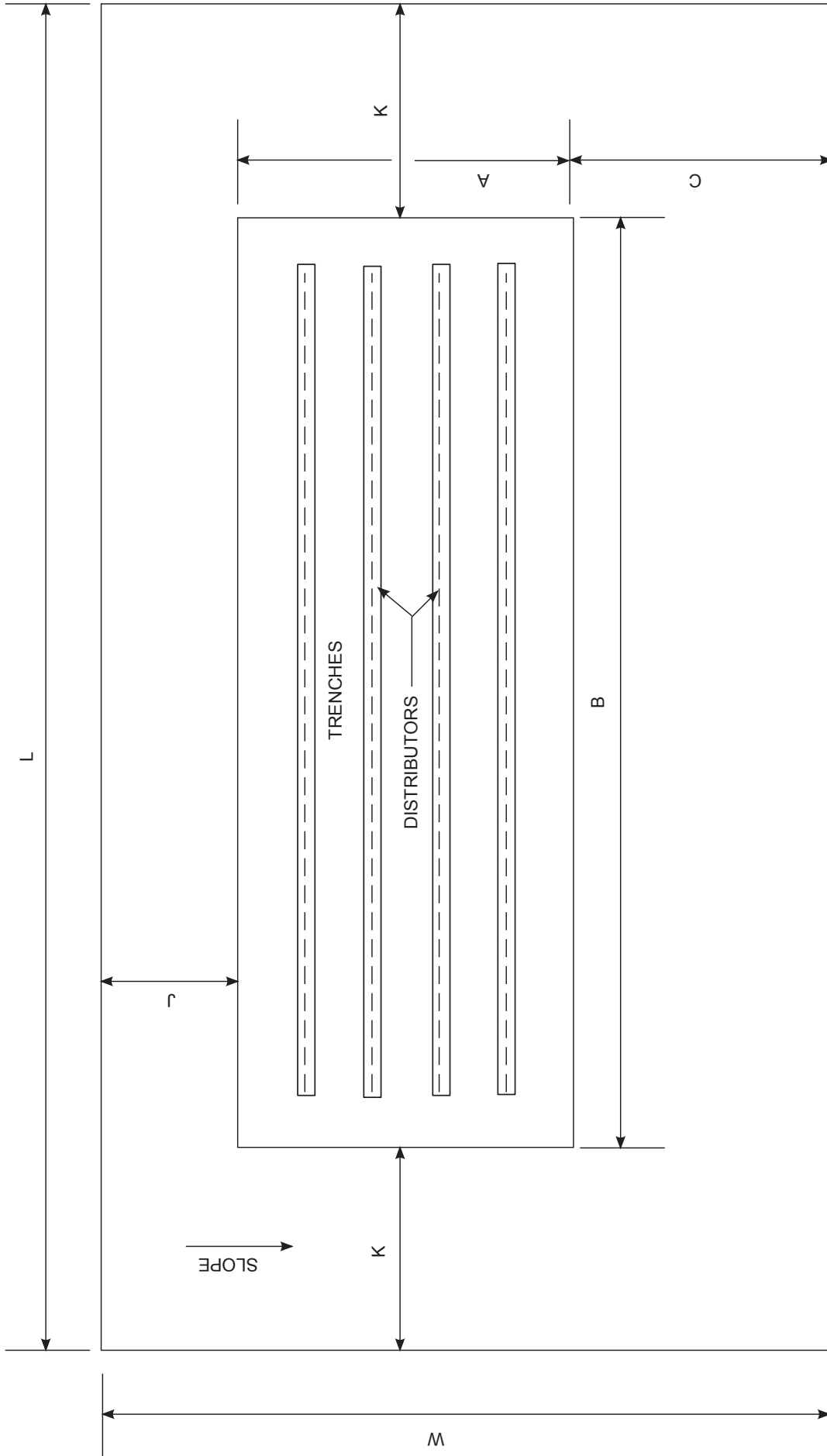
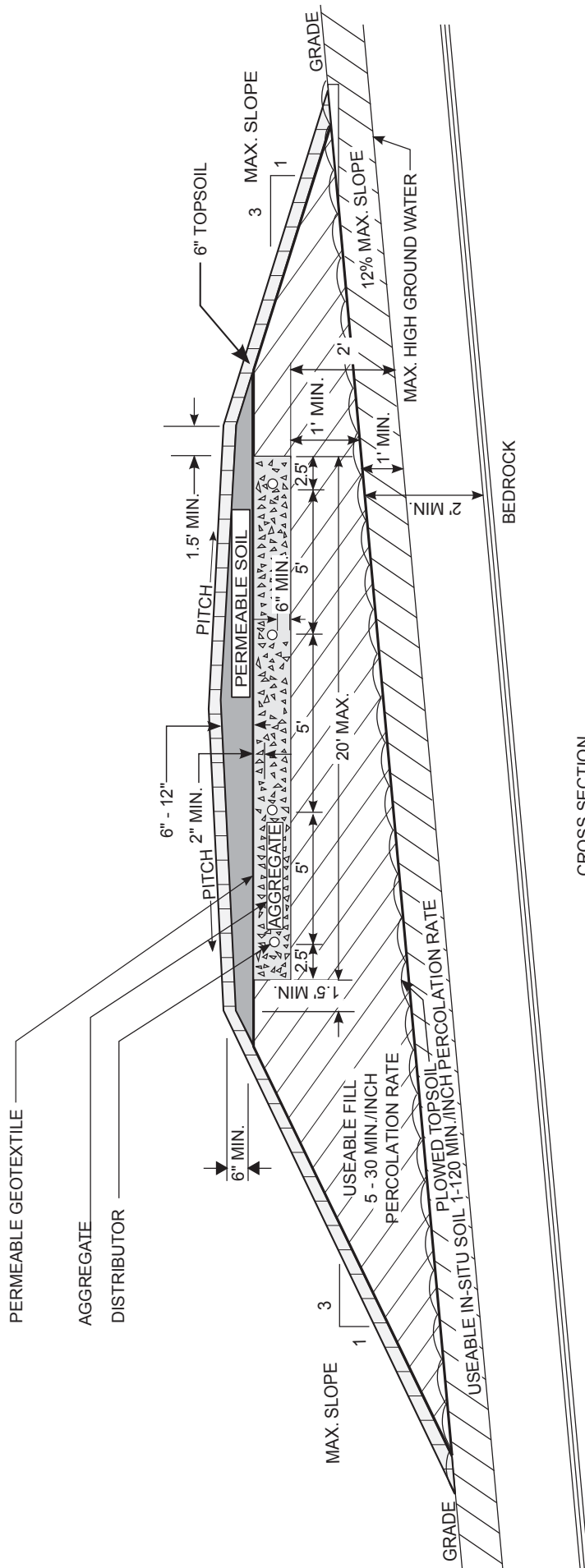

FIGURE 30A: TYPICAL MOUND DIMENSIONS - TOP VIEW - ABSORPTION TRENCHES



CROSS SECTION

- NOTES:**
1. Only soils with a percolation rate between five (5) and thirty (30) minutes per inch shall be used for the fill material. Sands with greater than 10% by weight finer than 0.05 mm material must be avoided. At least 25% of the material by weight shall be in the range of 0.50 mm to 2.0 mm. Less than 15% of the material by weight shall be larger than a 1/2 inch sieve. A sieve analysis may be necessary to verify this requirement.
 2. Preparation of the site on which the mound is to be located, placement of the fill on the site, construction of the absorption trenches or bed, grading the exposed fill, and grading/seeding the top soil are critical to proper operation of the mound system.
 3. Use Table 7A or 7B of this handbook for bed size based upon fill material percolation rate.

FIGURE 13: TYPICAL MOUND - CROSS SECTION WITH ABSORPTION BED

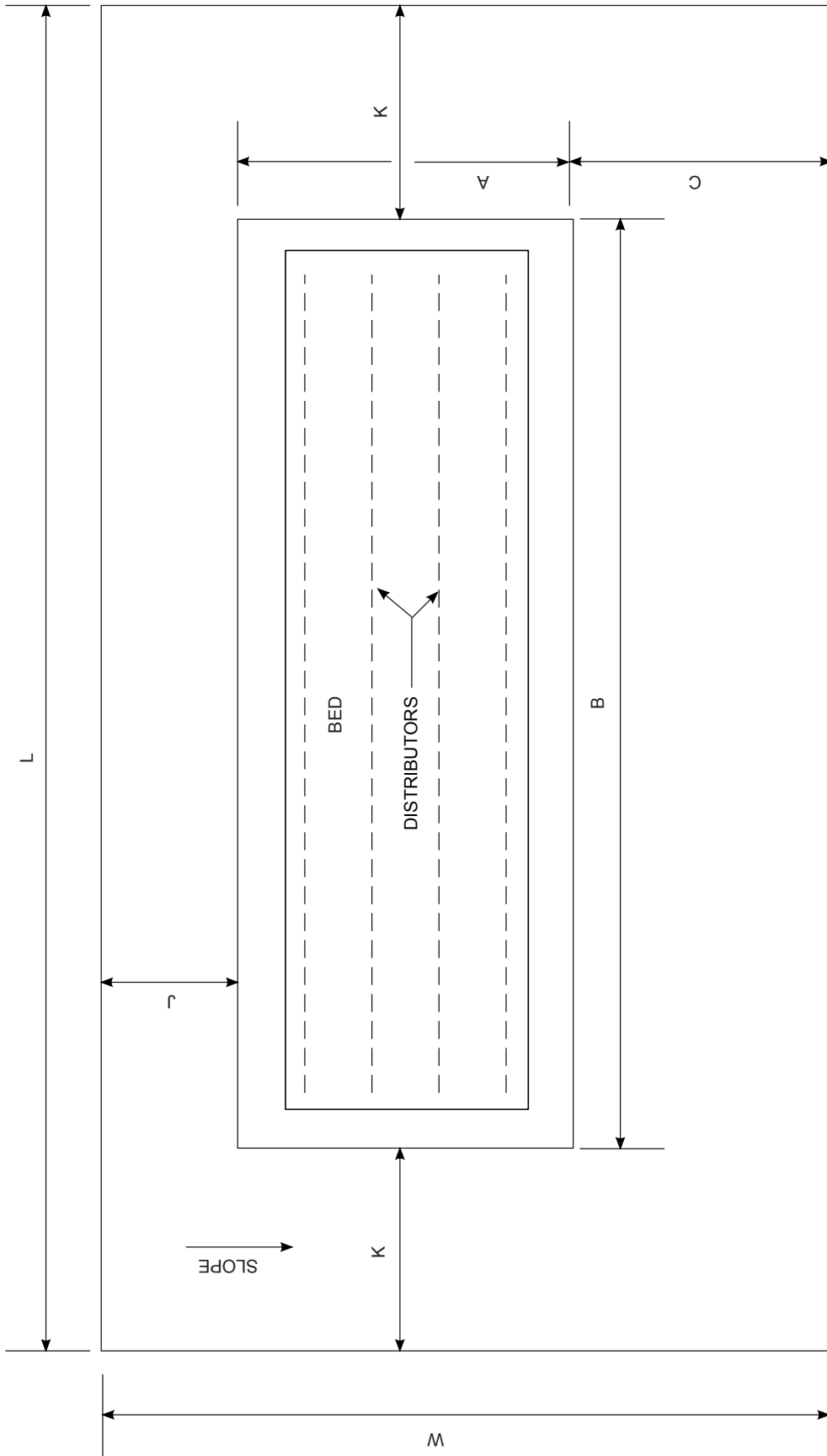
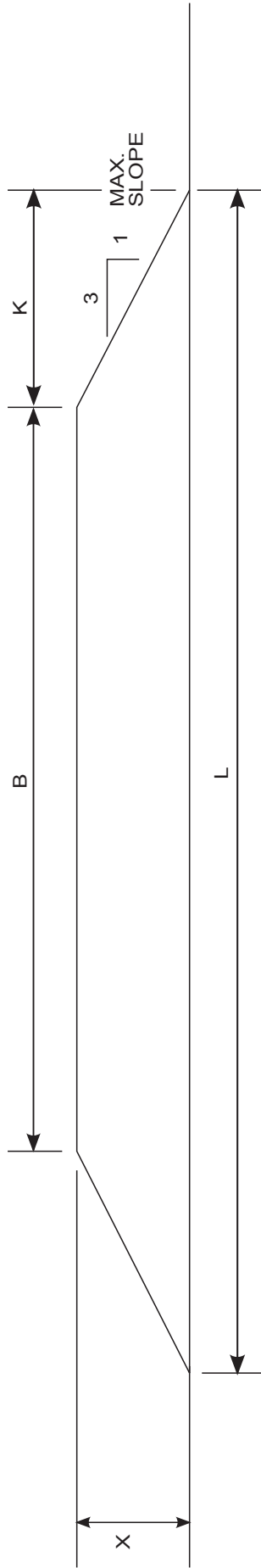
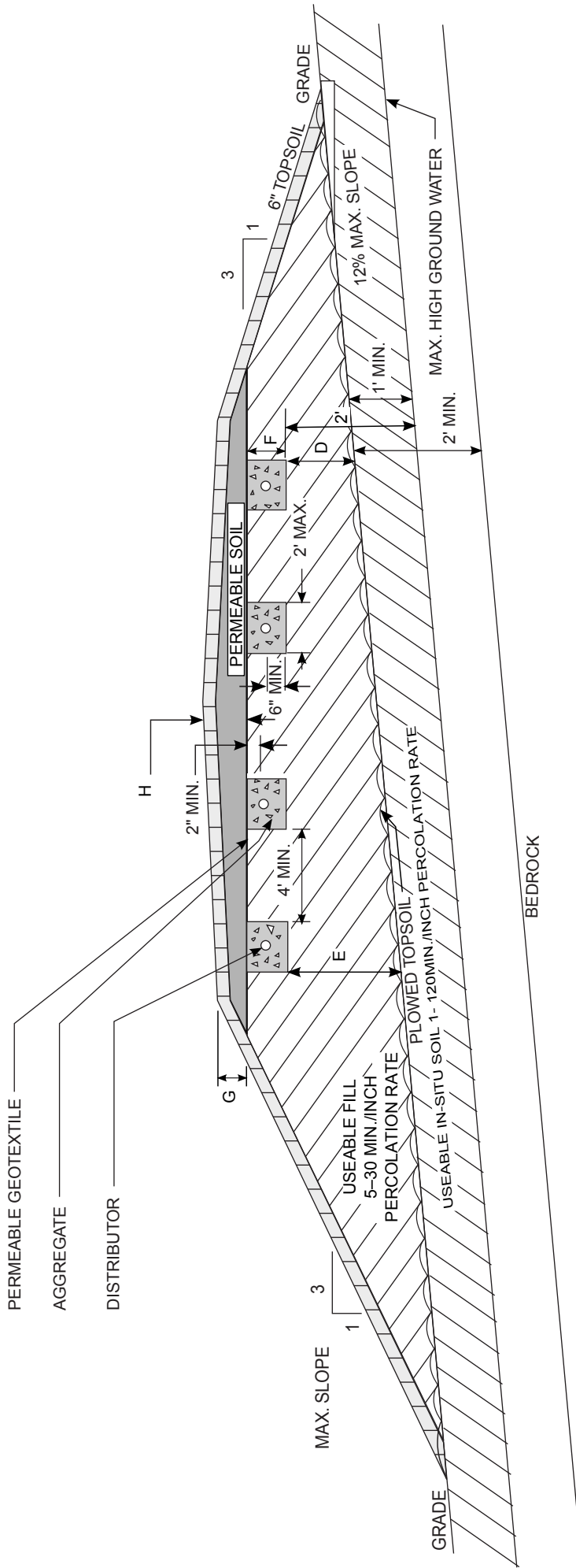

FIGURE 31A: TYPICAL MOUND DIMENSIONS - TOP VIEW WITH ABSORPTION BED



NOTE: $X = H + F + \left(\frac{D+E}{2}\right)$
 (See Figure 32A or 32B)

FIGURE 32: TYPICAL MOUND DIMENSIONS - SIDE VIEW



- NOTES:**
1. Only soils with a percolation rate between five(5) and thirty (30) minutes per inch shall be used for the fill material. Sands with greater than 10% by weight finer than 0.05 mm material must be avoided. At least 25% of the material by weight shall be in the range of 0.50 mm to 2.0 mm. Less than 15% of the material by weight shall be larger than a 1/2 inch sieve. A sieve analysis may be necessary to verify this requirement.
 2. Preparation of the site on which the mound is to be located, placement of the fill on the site, construction of the absorption trenches or bed, grading the exposed fill, and grading/seeding the top soil are critical to proper operation of the mound system.
 3. Use Table 6A or 6B of this handbook for trench lengths based upon fill material.

FIGURE 32A: TYPICAL MOUND DIMENSIONS - CROSS SECTION WITH ABSORPTION TRENCHES

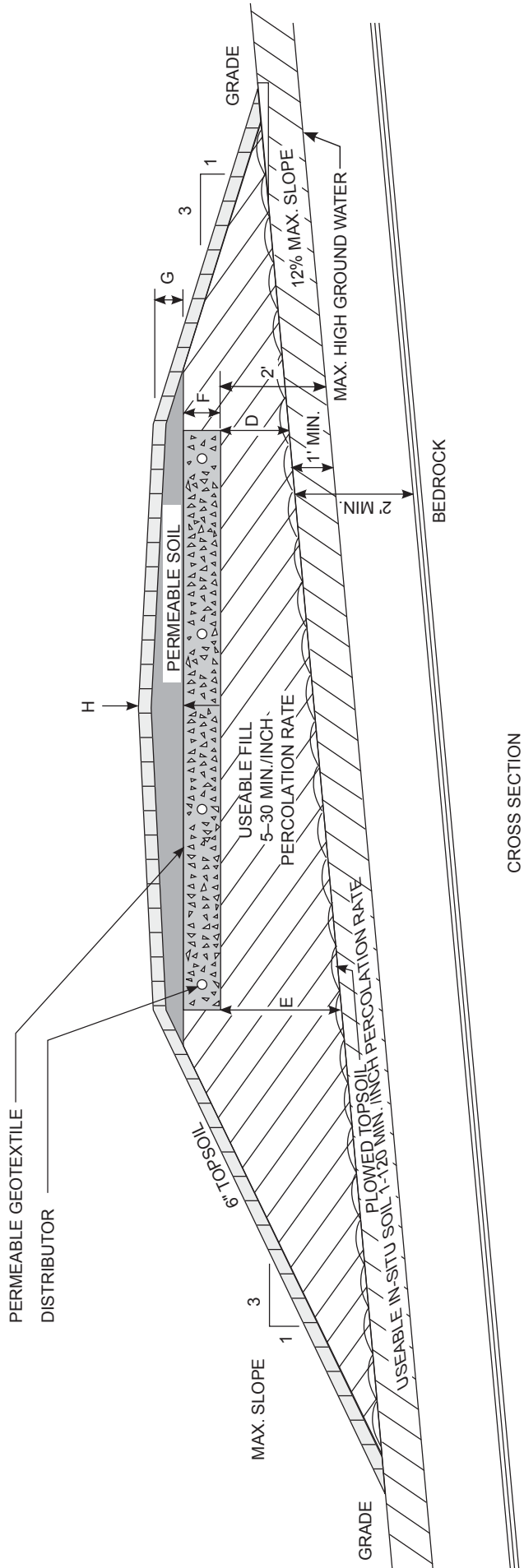

CROSS SECTION

- NOTES:**
1. Only soils with a percolation rate between five (5) and thirty (30) minutes per inch shall be used for the fill material. Sands with greater than 10% by weight finer than 0.05 mm material must be avoided. At least 25% of the material by weight shall be in the range of 0.50 mm to 2.0 mm. Less than 15% of the material by weight shall be larger than a 1/2 inch sieve. A sieve analysis may be necessary to verify this requirement.
 2. Preparation of the site on which the mound is to be located, placement of the fill on the site, construction of the absorption trenches or bed, grading the exposed fill, and grading/seeding the top soil are critical to proper operation of the mound system.
 3. Use Table 7A or 7B of this handbook for bed size based upon fill material.

FIGURE 32B: TYPICAL MOUND DIMENSIONS - CROSS SECTION WITH ABSORPTION BED

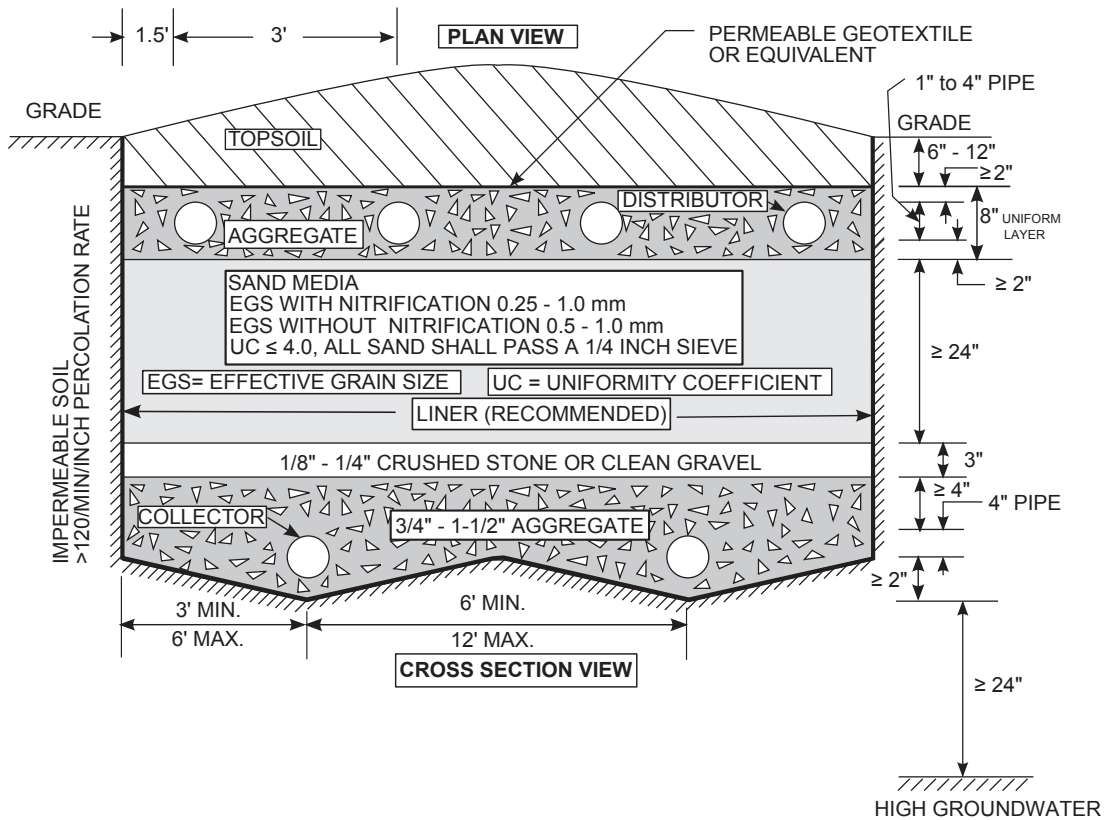
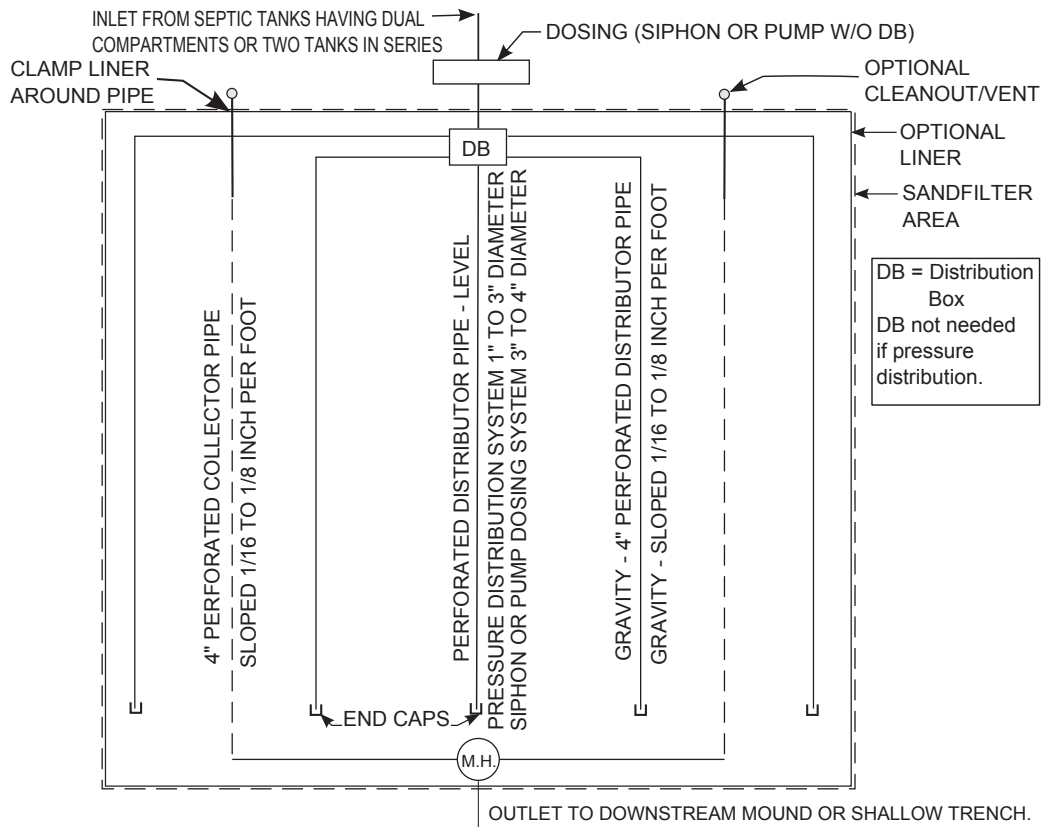

NOTES:

1. A Single Center Collector may be used when the filter width does not exceed 12 Feet.
2. Collector lines to be centered between distributor lines.
3. Gravity distribution may be used to apply effluent to small filters having less than 300 lineal feet of distributor or less than 900 square feet of filter area.

FIGURE 33: TYPICAL BURIED INTERMITTENT SAND FILTER

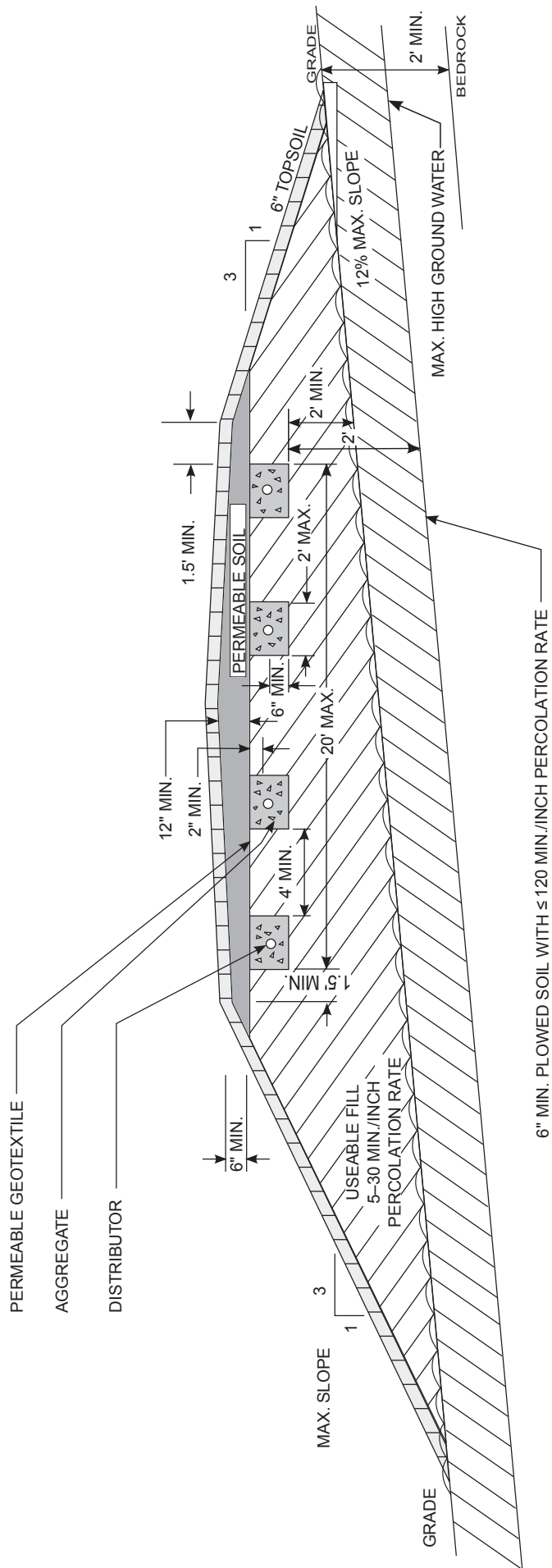
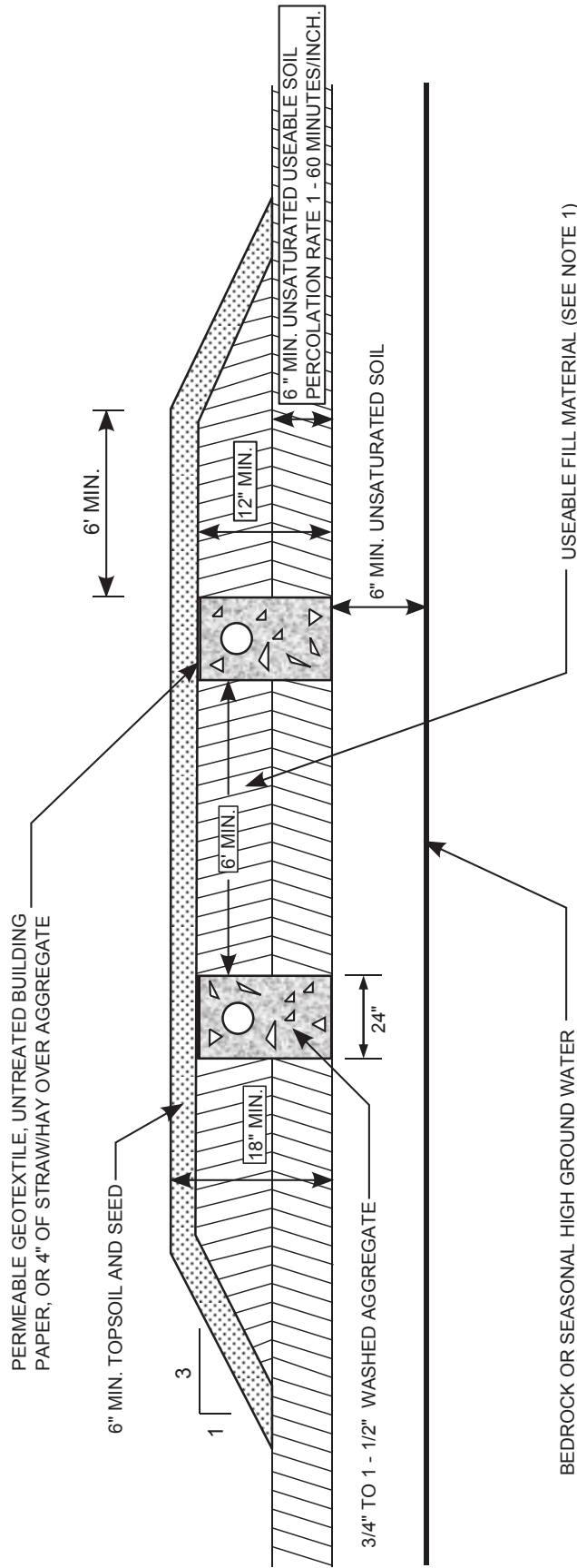

FIGURE 34: DOWNSTREAM "MODIFIED" MOUND



NOTES:

1. Sufficient soil similar to the insitu permeable soil shall be provided to assure a trench depth of at least 18 inches with a minimum one (1) foot depth of aggregate filled sidewall contacting permeable soil and at least 6 inches of aggregate filled sidewall in the permeable insitu soil.
2. Trenches shall be located at least 20 feet from drainage ditches.
3. Trenches should be as long as possible to minimize parallel trenches.
4. Distributor length shall not exceed 60 feet for gravity flow and 100 feet for pressure distribution.

FIGURE 35: DOWNSTREAM "MODIFIED" SHALLOW ABSORPTION TRENCH SYSTEM

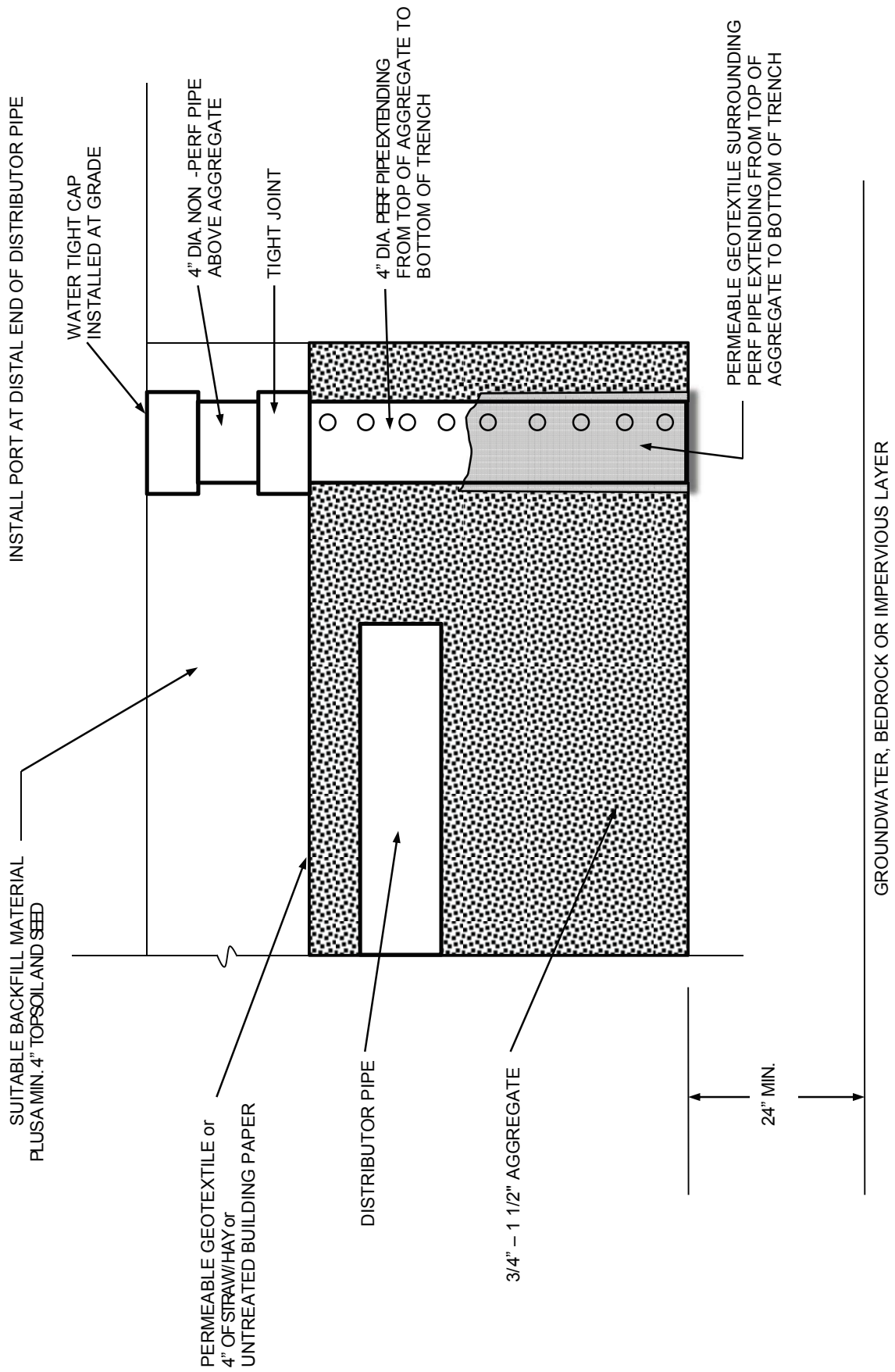
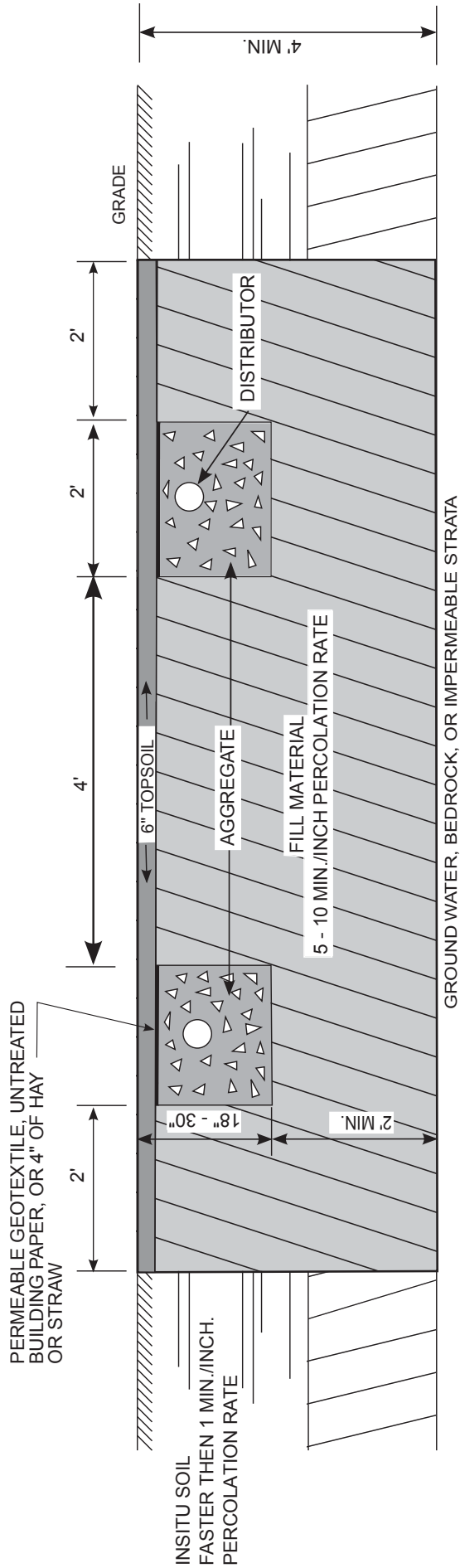

FIGURE 36: OBSERVATION PORT DETAIL



- NOTES:**
1. On sloped sites, a diversion ditch shall be constructed uphill from the fill and trench area to prevent surface runoff from entering the absorption area.
 2. A minimum of four (4) feet of unsaturated soil shall be available above boundary conditions.
 3. All minimum vertical and horizontal separation distances can be maintained as described in table 2.
 4. The insitu soil with a percolation rate faster than one (1) minute per inch shall be removed and replaced by soil having a percolation rate of five (5) to ten (10) minutes per inch.
 5. The required length of absorption trench is based upon the percolation of the fill material.
 6. The area excavated and filled must provide at least a two (2) foot buffer below and in each direction beyond the trenches.

FIGURE 37: SITE MODIFICATION FOR VERY FAST PERCOLATING SOILS

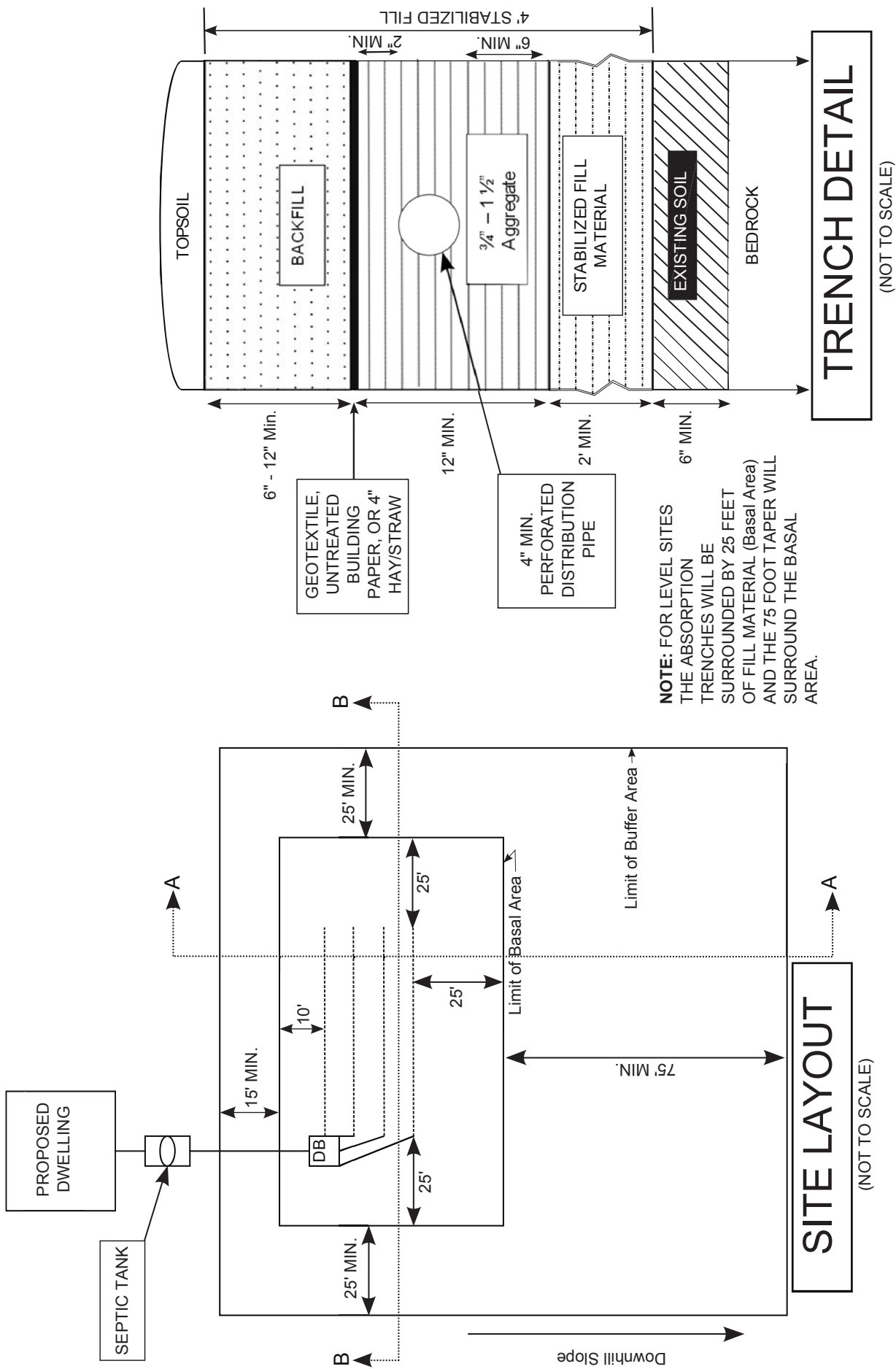
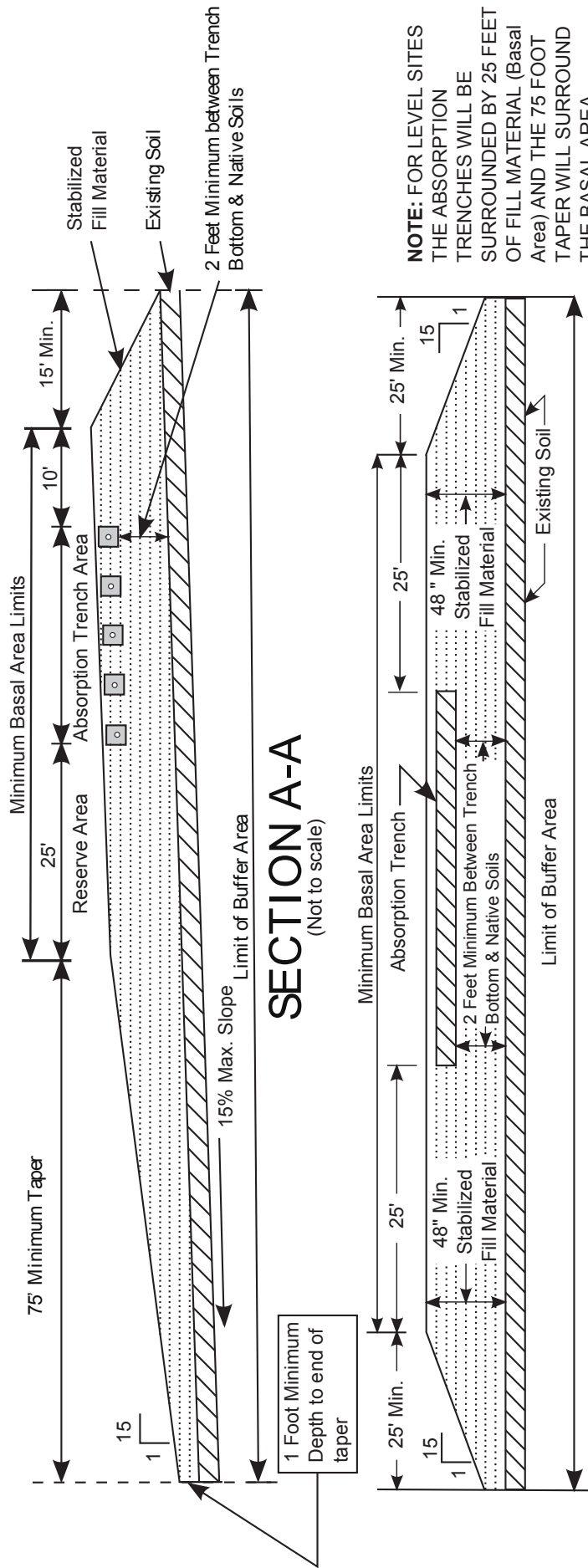

FIGURE 38: SITE MODIFICATION FOR LIMITED SURFICIAL USEABLE SOIL - TOP VIEW



NOTES:

- Sites with only six (6) inches of in situ useable soil and slopes not exceeding 15% may be modified to accommodate a conventional absorption trench system provided all of the following are met:
1. Laterals shall be placed 6 feet o.c.
 2. The depth of useable soil (i.e., in situ plus fill) is at least 4 feet for the proposed absorption system.
 3. A 12 inch depth of useable soil (i.e., in situ plus fill) shall extend 100 feet in the expected direction of the flow from the proposed absorption systems, 25 feet parallel to contours, and 20 feet upslope for slopes of one to 15 percent. 110 feet radially is needed for slopes < one percent.
 4. System shall not be built on sites with seasonal high groundwater unless the owner can demonstrate improvements that will divert groundwater from system and prevent any saturation of the fill material.
 5. System shall not be constructed on parcels where there is less than 6 inches of naturally occurring soils from original grade to solid bedrock. System shall not be constructed on parcels where fractured bedrock exists at grade or within 2 feet of original grade.
 6. A system shall not be built in unstabilized fill material. The fill material shall be allowed to settle naturally for a period of at least six months to include one freeze-thaw cycle, or may be stabilized by mechanical compaction in shallow lifts if a fill material consisting of only granular sand or sandy loam is used.
 7. Deep hole and percolation tests are conducted on the stabilized fill during the normal high ground water period since mottling is not applicable to recently filled sites. The results must be satisfactory for the site to be used for wastewater treatment.
 8. Trench construction shall meet Appendix 75-A requirements.
 9. General construction practices, setback requirements, hydraulic loading, etc. shall meet the requirements set forth in Appendix 75-A.

FIGURE 38A: SITE MODIFICATION FOR LIMITED SURFICIAL USEABLE SOIL - SIDE VIEW

TYPICAL LEACHING CESSPOOL CONSTRUCTION

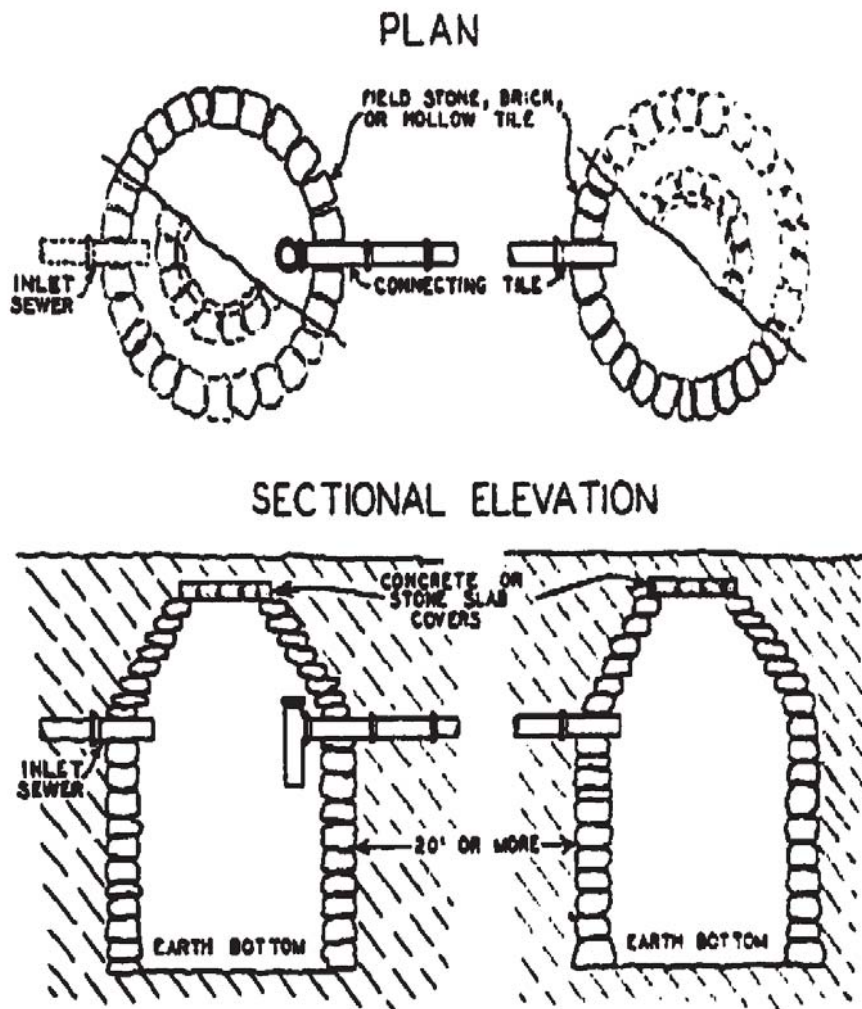

FIGURE 12

“Rural Water Supply and Sewage Disposal Systems”

C.A. Holmquist, Director, Division of Sanitation

NYSDOH

1932

This diagram is for historical interest only. Do not use for plan or design preparation.

TABLES

Sub-surface Irrigation

Page 2

Slopes of main drains should be about 1% and of lateral tile about 0.5%.

Joints should be protect by tarred paper or collars and well embedded in gravel or broken stone.

The form or size of the tile has no affect on the required length, but the width of the trench does.

Tile content:-

2" - 0.163 g.p.f.	5" - 1.02 g.p.f.
3" - 0.367 g.p.f.	6" - 1.47 g.p.f.
4" - 0.653 g.p.f.	8" - 2.61 g.p.f.

Explanation of Tables

The Test for time to fall 1 inch is made in a hole 12" square and 18" deep filled with water to a depth of 6". The ground must be thoroughly wet before the test is made.

For cesspools the hole is dug in the bottom of a test-pit about the depth of the cesspool.

The "gallons per day" is in terms of the area of the bottom of the test hole and is for purpose of comparison only.

"Safe gallons per day" is in terms of total area to the flow line.

Conditions above are assumed complied with.

Sub surface irrigation Rates

Time to fall in.	Gal. per sq. ft. per day	Safe gal. per sq. ft. per day	Safe ft. of tile per capita		
			School	Factory	Dwelling
13 Sec.	4000	4.0	4.0	4.4	20.0
15 "	3200	3.9	4.3	4.6	20.0
20 "	2700	3.8	4.6	4.8	20.0
25 "	2150	3.7	4.3	5.0	20.0
30 "	1800	3.6	5.3	5.4	21.0
45 "	1200	3.4	5.5	5.1	22.0
1 Min.	897	3.3	6.0	6.5	24.0
1½ "	600	3.1	6.2	7.0	25.0
2 "	450	2.9	6.5	7.5	26.0
2½ "	360	2.8	6.8	8.4	27.0
3 "	300	2.7	7.2	9.0	29.0
3½ "	250	2.5	7.9	10.0	32.0
4 "	220	2.4	8.0	11.0	33.0
5 "	180	2.2	9.0	11.5	36.0
7 "	130	2.0	10.0	12.5	40.0
10 "	90	1.7	12.0	15.0	48.0
15 "	60	1.4	14.0	18.0	57.0
20 "	45	1.1	18.0	24.0	71.0
30 "	30	0.9	24.0	30.0	96.0
45 "	20	0.7	30.0	31.0	120.0
1 Hr.	15	0.4	45.0	57.0	180.0
1½ "	10	0.3	75.0	95.0	300.0
2 "	7½	0.2	95.0	120.0	370.0
3 "	5	0.14	150.0	190.0	600.0
5 "	3	0.07	300.0	370.0	1200.0
10 "	1½	0.03	600.0	750.0	2400.0

For explanation see notes on Sub-surface Irrigation.

"Notes on Sanitary Engineering, Hydraulics, sewerage, sewage disposal, water supply"

Henry Ryon

1924

This table and text is for historical interest only. Do not use for plan or design preparation.

TABLE 1	
DAILY DESIGN FLOWS	
Plumbing Fixtures (based on manufactured date)	Minimum Design Flow (gallons/day/bedroom)
Post-1994 Fixtures 1.6 gallons/flush toilets 2.5 gallons/minute faucets & showerheads	110
Pre-1994 Fixtures 3.5 gallons/flush toilets 3.0 gallons/minute faucets & showerheads	130
Pre-1980 Fixtures 3.5+ gallons/flush toilets 3.0+ gallons/minute faucets & showerheads	150
Waterless Toilets (e.g., composter) (greywater discharge only)	75

Note:

Table 1 shows minimum daily design flows based upon the number of bedrooms. Designs may also need to account for additional factors that can effect daily discharge quantity and quality such as: installation of high water use products and fixtures (e.g., whirlpool baths, spas and multi-head shower systems), home businesses (e.g., hair styling, daycare, catering), rooms which may be converted to additional permanent bedrooms in the future or other intended uses that will affect discharge quantity and quality.

**TABLE 2
REQUIRED SEPARATION DISTANCES FROM WASTEWATER TREATMENT SYSTEM COMPONENTS
(FEET)**

System Components	Well or Suction Line (e)(g)	Stream, Lake, Watercourse (b), or Wetland	Dwelling	Property Line	Drainage Ditch or Rain Gardens (h)
House Sewer Drain (watertight joints)	25 if cast iron, 50 otherwise	25	3	10	10
Septic Tank, Dosing Tank or watertight ETU	50	50	10	10	10
Effluent Line to Distribution Box/Drop Box	50	50	10	10	10
Distribution Box/Drop Box	100	100	20	10	20
Absorption Field (c)(d)	100 (a)	100	20	10	20
Seepage Pit(d)	150 (a)	100	20	10	20
Raised System or Mound (c)(d)	100 (a)	100	20	10	20
Intermittent Sand Filter (d)	100 (a)(f)	100 (f)	20	10	20
Non-Waterborne Systems with offsite residual disposal	50	50	20	10	10
Non-Waterborne Systems with onsite discharge	100	50	20	10	20

Notes:

- a) When wastewater treatment systems are located upgrade and in the direct path of surface water drainage to a well, the closest part of the treatment system shall be at least 200 feet away from the well.
 - b) Mean high water mark. Wetland or watercourse determinations should be addressed with the LHD or other agency having jurisdiction and the applicable NYSDEC regional office.
 - c) For all systems involving the placement of fill material, separation distances are measured from the toe of the slope of the fill, except for some shallow absorption trench systems as described in Section 9.12.2 of this Handbook.
 - d) Separation distances shall also be measured from the edge of the designated additional useable area (i.e., reserve area), when available.
 - e) The closest part of the wastewater treatment system shall be located at least ten (10) feet from any water service line (e.g., public water supply main, public water service line or residential well water service line).
 - f) When intermittent sand filters are designed to be watertight and collect all effluent, the separation distance can be reduced to 50 feet.
 - g) The listed water well separation distances from contaminant sources shall be increased by 50% whenever aquifer water enters the water well at less than 50-feet below grade. If a 50% increase cannot be achieved, then the greatest possible increase in separation distance shall be provided with such additional measures as needed to prevent contamination.
 - h) Recommended; use site evaluation to avoid OWTS short-circuiting to the surface or groundwater and to minimize impacts on OWTS functionality.
- Embankment or very steep slope:** It is recommended that system components be located a minimum of 25 feet and the absorption field be located a minimum of 50 feet from an embankment or very steep slope. Maximize separation distances and use site evaluation to avoid short-circuiting to surface (breakout or seepage).
- Swimming pools (above or below ground):** It is recommended that system components be located a minimum of 20 feet and the absorption field be located a minimum of 35 feet from swimming pools. Maximize separation distances and use site evaluation to minimize impacts on OWTS accessibility and functionality.

TABLE 3**MINIMUM SEPTIC TANK CAPACITIES**

Number of Bedrooms	Minimum Tank Capacity (gallons)	Minimum Liquid Surface Area (ft ²)
1, 2, 3	1,000	27
4	1,250	34
5	1,500	40
6	1,750	47

NOTES:

- a) Tank size requirements for more than six (6) bedrooms shall be calculated by adding 250 gallons and seven (7) square feet of surface area for each additional bedroom.
- b) A garbage grinder shall be considered equivalent to an additional bedroom for determining septic tank size.
- c) A whirlpool bath or spa (connected to house plumbing) should be considered equivalent to an additional bedroom for determining septic tank size.

TABLE 4

SITE REQUIREMENTS FOR DESIGN OF RESIDENTIAL ONSITE WASTEWATER TREATMENT SYSTEMS

Method of Subsurface Treatment	Depth of Percolation Test Hole for System Design (inches)	Minimum Required Depth of In-situ Useable Soil (i.e., 1-60 min/in unless otherwise stated) (feet)	Minimum Separation Between Trench Bottom and Boundary Condition (groundwater, soil mottling, bedrock, or impermeable strata) (feet)	Allowable Percolation Rate of site soil (min/inch)	Allowable slope of site (percent)
CONVENTIONAL SYSTEMS					
Conventional Absorption Trenches and Gravelless Trench Products	24 – 30	4	2	1 – 60	0 – 15 15 – 20 ⁽⁵⁾
Deep Absorption Trenches	at trench depth	4	2	1 – 60	0 – 15
Shallow Absorption Trenches	at trench depth ⁽¹⁾	2	2	1 – 60	0 – 15
Cut and Fill System	12 (into in-situ useable soil ⁽²⁾)	3	2	1 – 60	0 – 15
Absorption Bed	24 – 30	4	2	1 – 30	0 – 8
Seepage Pit	At pit depth and half of pit depth <u>or</u> at each usable soil layer	3 (from bottom of pit)	3 (from bottom of pit)	1 – 60	0 – 15
ALTERNATIVE SYSTEMS					
Raised System	12	1	2 (if dosing device used ⁽³⁾)	1 – 60	0 – 15
Mound	12	1	2 (to ground water), 3 (to bedrock ⁽⁴⁾)	1 – 120	0 – 12
Intermittent Sand Filter	_____	0	2	_____	0 – 15
modified mound (following a sand filter)	6 and 12	0.5	after placement of fill: 2.5 (to groundwater), 4 (to bedrock)	1 – 120 at 6” unlimited at 12”	0 – 12
modified shallow trench (following a sand filter)	6 and 12	1	0.5	1–60 at 6” unlimited at 12”	0 – 15

NOTES:

- 1) A percolation test must be conducted at the depth of the bottom of the proposed trenches. If the trench bottoms will be between grade and six (6) inches deep, conduct the test at six (6) inch depth.
- 2) A percolation test must also be conducted 24-30 inches below grade in stabilized soil (in-situ or fill). The slower of the two (2) percolation rates shall be used for design of the system.
- 3) If no dosing device is used, a minimum of three (3) feet of usable soil must be present beneath the bottom of the trenches (requires local health department inspection and certification program).
- 4) There must be at least two (2) feet of naturally occurring soil above bedrock.
- 5) With additional trench spacing and depth of useable soil as described in Section 9.6.4.1 of this Handbook.

TABLE 5	
NOMINAL PIPE VOLUME PER LINEAL FOOT	
Diameter (inches)	Volume (gallons)
1.0	0.0408
1.25	0.0638
1.5	0.0918
2.0	0.163
2.5	0.255
3.0	0.367
4.0	0.653
5.0	1.020
6.0	1.470

Example Dosing Volume Calculation using Table 5:

Site evaluation results in a design utilizing 240 feet of conventional absorption trenches with of 4.0-inch diameter perforated distribution pipe. From Table 5, 4.0-diameter pipe has a capacity of 0.653 gallons/foot.

Total pipe volume = (240 feet) X (0.653 gallons/foot)

Total pipe volume = 157 gallons

Per Section 8.6 of this Handbook, the dose shall be 75% to 85% of the total pipe volume. For this 75% of the total volume is used:

Dose volume = (157 gallons) X (0.75)

Dose volume = 118 gallons per dose

Based upon pump chamber dimensions (see Figure 7), set pump floats to deliver about 118 gallons per dose.

NOTES:

- 1) When a force main (pipe from pump chamber to distribution box) empties back into the pump chamber after each dose, 100% of the force main volume shall be added to the calculated absorption area dose volume. Use Table 5 to calculate force main pipe volume.
- 2) Siphons operate by gravity therefore the force main will always empty. Bell should be set or siphon system purchased that will deliver the calculated dose volume only.
- 3) Many gravelless trench products use a similar dose volume per linear feet of trench (assume a 4.0 inch pipe volume); however, the manufacturer's recommendations for dosing should be followed.

TABLE 6A

**REQUIRED LENGTH OF CONVENTIONAL ABSORPTION TRENCH
FOR STANDARD DAILY DESIGN FLOWS
(FEET)
(BASED UPON TWO (2) FOOT WIDE TRENCH)**

Percolation Rate (min/inch)	Application Rate (gal/day/ft ²)	Daily Flow Rate (gallons per day)														
		2 Bedrooms			3 Bedrooms			4 Bedrooms			5 Bedrooms			6 Bedrooms		
		220	260	300	330	390	450	440	520	600	550	650	750	660	780	900
1 – 5	1.20	92	108	125	138	162	187	184	216	250	230	270	312	275	325	374
6 – 7	1.00	110	130	150	165	195	225	220	260	300	275	325	375	330	390	450
8 – 10	0.90	123	145	167	184	217	250	245	290	333	306	360	417	367	433	500
11 – 15	0.80	138	162	188	207	244	281	275	325	375	344	406	469	413	488	563
16 – 20	0.70	158	186	214	236	279	321	315	372	429	393	464	536	472	557	643
21 – 30	0.60	184	217	250	275	325	375	367	433	500	459	542	625	550	650	750
31 – 45	0.50	220	260	300	330	390	450	440	520	600	550	650	750	660	780	900
46 – 60	0.45	245	290	333	367	433	500	489	578	667	612	722	833	734	867	1000
Dosing required if there is 500-foot or more of total trench length																
Alternate Dosing required if there is 1000-foot or more of total trench length																

TABLE 6B

**CONVENTIONAL ABSORPTION TRENCH
APPLICATION RATES FOR
NON-STANDARD DAILY DESIGN FLOWS**

Percolation Rate (minutes/inch)	Application Rate (gallons/day/ft ²)
1 - 5	1.20
6 - 7	1.00
8 - 10	0.90
11 - 15	0.80
16 - 20	0.70
21 - 30	0.60
31 - 45	0.50
46 - 60	0.45
Soil with a percolation rate of less than one (1) minutes/inch is unsuitable for a conventional system.	
Required Total Trench Bottom Area (ft ²) = Flow Rate (GPD)/Application Rate (GPD/ft ²)	
Required Total Absorption Trench Length = Required Total Trench Bottom Area (ft ²)/2 feet (trench width)	

TABLE 6C**ADJUSTED REQUIRED LENGTH OF ABSORPTION TRENCH
FOR STANDARD DAILY DESIGN FLOWS****QUALIFYING OPEN-BOTTOM GRAVELLESS CHAMBERS¹ OR
GRAVELLESS MEDIA-WRAPPED CORRUGATED PIPE SAND-LINED SYSTEMS²
(FEET)****(BASED UPON A TWO (2) FEET WIDE TRENCH)**

Percolation Rate (min/inch)	Application Rate (gal/day/ft ²)	Flow Rate (gallons per day)														
		2 bedrooms			3 bedrooms			4 bedrooms			5 bedrooms			6 bedrooms		
		220	260	300	330	390	450	440	520	600	550	650	750	660	780	900
1 - 5	1.20	69	81	94	103	122	141	138	163	188	172	203	234	206	244	281
6 - 7	1.00	83	98	113	124	146	169	165	195	225	206	244	281	248	293	338
8 - 10	0.90	92	108	125	138	163	188	183	217	250	229	271	313	275	325	375
11 - 15	0.80	103	122	141	155	183	211	206	244	281	258	305	352	309	366	422
16 - 20	0.70	118	139	161	177	209	241	236	279	321	295	348	402	354	418	482
21 - 30	0.60	138	163	188	206	244	281	275	325	375	344	406	469	413	488	563
31 - 45	0.50	165	195	225	248	293	338	330	390	450	413	488	563	495	585	675
46 - 60	0.45	183	217	250	275	325	375	367	433	500	458	542	625	550	650	750

¹ 25% Trench length reduction per Appendix 75-A.8(c)(3)(i)² 25% Trench length reduction per Appendix 75-A.8(c)(3)(ii)

Trenches shall be equal in length. If necessary, the total trench length of each lateral shall be rounded up to create equal trench lengths.

TABLE 6D**ADJUSTED REQUIRED LENGTH OF ABSORPTION TRENCH
FOR STANDARD DAILY DESIGN FLOWS****GRAVELLESS GEOTEXTILE SAND FILTER SYSTEMS¹
(FEET)****(BASED UPON A FOUR (4) FEET WIDE TRENCH)**

Percolation Rate (min/inch)	Application Rate (gal/day/ft ²)	Flow Rate (gallons per day)														
		2 bedrooms			3 bedrooms			4 bedrooms			5 bedrooms			6 bedrooms		
		220	260	300	330	390	450	440	520	600	550	650	750	660	780	900
1 - 5	1.20	31	36	42	46	54	63	61	72	83	76	90	104	92	108	125
6 - 7	1.00	37	43	50	55	65	75	73	87	100	92	108	125	110	130	150
8 - 10	0.90	41	48	56	61	72	83	81	96	111	102	120	139	122	144	167
11 - 15	0.80	46	54	63	69	81	94	92	108	125	115	135	156	138	163	188
16 - 20	0.70	52	62	71	79	93	107	105	124	143	131	155	179	157	186	214
21 - 30	0.60	61	72	83	92	108	125	122	144	167	153	181	208	183	217	250
31 - 45	0.50	73	87	100	110	130	150	147	173	200	183	217	250	220	260	300
46 - 60	0.45	81	96	111	122	144	167	163	193	222	204	241	278	244	289	333

¹ Trench bottom sizing criteria of six (6) ft²/ foot of trench per Appendix 75-A.8(c)(3)(iii)

Trenches shall be equal in length. If necessary, the total trench length of each lateral shall be rounded up to create equal trench lengths.

TABLE 6E**ADJUSTED REQUIRED LENGTH OF ABSORPTION TRENCH
FOR STANDARD DAILY DESIGN FLOWS****ENHANCED TREATMENT UNITS (ETU)*
(FEET)****(BASED UPON A TWO (2) FEET WIDE TRENCH)**

Percolation Rate (min/inch)	Application Rate (gal/day/ft ²)	Flow Rate (gallons per day)														
		2 bedrooms			3 bedrooms			4 bedrooms			5 bedrooms			6 bedrooms		
		220	260	300	330	390	450	440	520	600	550	650	750	660	780	900
1 - 5	1.20	61	73	84	92	109	126	123	145	168	154	181	209	184	218	251
6 - 7	1.00	74	87	101	111	131	151	147	174	201	184	218	251	221	261	302
8 - 10	0.90	82	97	112	123	145	168	164	194	223	205	242	279	246	290	335
11 - 15	0.80	92	109	126	138	163	188	184	218	251	230	272	314	276	327	377
16 - 20	0.70	105	124	144	158	187	215	211	249	287	263	311	359	316	373	431
21 - 30	0.60	123	145	168	184	218	251	246	290	335	307	363	419	369	436	503
31 - 45	0.50	147	174	201	221	261	302	295	348	402	369	436	503	442	523	603
46 - 60	0.45	164	194	223	246	290	335	328	387	447	409	484	558	491	581	670

* 33% total trench length reduction and located under the jurisdiction of an RME or local code for maintenance per Appendix 75-A.6(6)(ii)(d)

TABLE 7A**ABSORPTION BEDS****REQUIRED BOTTOM AREA FOR STANDARD DAILY DESIGN FLOWS
(FT²)**

Percolation Rate (min/in)	Application Rate (gal/day/ft ²)	Daily Flow Rate (gallons per day)														
		2 bedrooms			3 bedrooms			4 bedrooms			5 bedrooms			6 bedrooms		
		220	260	300	330	390	450	440	520	600	550	650	750	660	780	900
1 - 5	0.95	232	274	316	347	411	474	463	547	632	579	684	789	695	821	947
6 - 7	0.80	275	325	375	413	488	563	550	650	750	688	813	938	825	975	1125
8 - 10	0.70	314	371	429	471	557	643	629	743	857	786	929	1071	943	1114	1286
11 - 15	0.60	367	433	500	550	650	750	733	867	1000	917	1083	1250	1100	1300	1500
16 - 20	0.55	400	473	545	600	709	818	800	945	1091	1000	1182	1364	1200	1418	1636
21 - 30	0.45	489	578	667	733	867	1000	978	1156	1333	1222	1444	1667	1467	1733	2000
30+	Not Acceptable															

TABLE 7B**ABSORPTION BEDS****REQUIRED BOTTOM AREA APPLICATION RATES FOR
NON-STANDARD DAILY DESIGN FLOWS**

Percolation Rate (minutes/inch)	Application Rate (gallons/day/ft ²)
1 - 5	0.95
6 - 7	0.80
8 - 10	0.70
11 - 15	0.60
16 - 20	0.55
21 - 30	0.45
30+	Not Acceptable

TABLE 8A**SEEPAGE PITS****REQUIRED ABSORPTIVE AREA FOR STANDAND DAILY DESIGN FLOWS
(FT²)**

Percolation Rate (min/in)	Application Rate (gal/day/ft ²)	Flow Rate (gallons per day)														
		2 bedrooms			3 bedrooms			4 bedrooms			5 bedrooms			6 bedrooms		
		220	260	300	330	390	450	440	520	600	550	650	750	660	780	900
1 – 5	1.20	183	217	250	275	325	375	367	433	500	458	542	625	550	650	750
6 – 7	1.00	220	260	300	330	390	450	440	520	600	550	650	750	660	780	900
8 – 10	0.90	244	289	333	367	433	500	489	578	667	611	722	833	733	867	1,000
11 – 15	0.80	275	325	375	413	488	563	550	650	750	688	813	938	825	975	1,125
16 – 20	0.70	314	371	429	471	557	643	629	743	857	786	929	1,071	943	1,114	1,286
21 – 30	0.60	367	433	500	550	650	750	733	867	1,000	917	1,083	1,250	1,100	1,300	1,500
31 – 45	0.50	440	520	600	660	780	900	880	1,040	1,200	1,100	1,300	1,500	1,320	1,560	1,800
46 – 60	0.45	489	578	667	733	867	1,000	978	1,156	1,333	1,222	1,444	1,667	1,467	1,733	2,000
Over 60	Unsuitable...Use Special Design															

TABLE 8B**SEEPAGE PITS (CYLINDRICAL)****DIMENSIONS FOR REQUIRED ABSORPTIVE AREA
(FT²)**

Diameter of Seepage Pit (feet)	EFFECTIVE STRATA DEPTH BELOW FLOW LINE (BELOW INLET)									
	1 foot	2 feet	3 feet	4 feet	5 feet	6 feet	7 feet	8 feet	9 feet	10 feet
3	9.4	19	28	38	47	57	66	75	85	94
4	12.6	25	38	50	63	75	88	101	113	126
5	15.7	31	47	63	79	94	110	126	141	157
6	18.8	38	57	75	94	113	132	151	170	188
7	22	44	66	88	110	132	154	176	198	220
8	25.1	50	75	101	126	151	176	201	226	251
9	28.3	57	85	113	141	170	198	226	254	283
10	31.4	63	94	126	157	188	220	251	283	314
11	34.6	69	104	138	173	207	242	276	311	346
12	37.7	75	113	151	188	226	264	302	339	377

Absorptive Area for Cylinder = πDh Absorptive Area for Rectangle = $(2W + 2L)h$

h – effective depth (Invert of inlet to bottom of seepage pit)

D – outside diameter in ft.

W – outside width in ft.

L – outside length in ft.

 $\pi = 3.14$

TABLE 9**RAISED SYSTEMS****MINIMUM SIZE OF BASAL AREAS¹ RECEIVING SEPTIC TANK OR ETU EFFLUENT
(FT²)**

Effluent Quality	Application Rate (gal/day/ft ²)	Flow Rate (gallons per day)														
		2 bedrooms			3 bedrooms			4 bedrooms			5 bedrooms			6 bedrooms		
		220	260	300	330	390	450	440	520	600	550	650	750	660	780	900
Septic Tank ²	0.20	1100	1300	1500	1650	1950	2250	2200	2600	3000	2750	3250	3750	3300	3900	4500
ETU ³	0.30	733	867	1000	1100	1300	1500	1467	1733	2000	1833	2167	2500	2200	2600	3000

NOTES:

1. Basal area is the area beneath the absorption trenches and extending 2.5 feet in all directions from the outer edge of the perimeter trenches. The use of slowly permeable soils for the fill material will result in a trench system that will have a basal area larger than the minimum area calculated using the above application rates for the various treatment systems.
2. A conventional absorption trench system is designed using the percolation rate of the fill material.
3. Located under the jurisdiction of an RME or local code for maintenance per Appendix 75-A.6(6)(ii)(d). A conventional absorption trench system is designed to distribute effluent evenly over the fill material basal area.

TABLE 10

GENERAL WAIVERS IN EFFECT

MUNICIPALITY	DATE	GENERAL WAIVER	AFFECTED STANDARDS
Nassau County	1979	Seepage pit design criteria.	75-A.4(d) & 75-A.8(h)(3) & 75-A.8(h)(4)(iv)
Erie County	1980	Mound design criteria.	75-A.9(c)(2)(iii) & 75-A.9(c)(3)(ii)
	1981	Soil test modifications and seepage pit design criteria.	75-A.4(d) & 75-A.8(h)(2)(f)
	1982	Seepage pit design criteria.	75-A.8(h)(2)(ii) & 75-A.8(h)(3)
Suffolk County		Modified separation requirement between septic tank and dwelling slab.	75-A.4(b)
		Modified separation requirement between absorption facilities and property lines.	75-A.4(b)
	1993	Allow absorption facilities 60 to 150 feet from individual wells with added protective measures for wells	75-A.4(b)
		Allow multiple septic tank outlets under specific conditions.	75-A.8(h)(4)(ii)
		Modified vertical separation requirement between seepage pits and high ground water.	75-A.8(h)(2)(ii) & 75-A.8(h)(3)
		Modified separation requirement between adjacent seepage pits.	75-A.8(h)(3)(vi)
Orleans County	1982	Mound Design criteria	75-A.9(c)(3)(ii) & 75-A.9(c)(3)(iv)
Tompkins County	1992	Modifying $\leq 20\%$ slope to $\leq 15\%$ slope plus stabilization prior to soil/ground water tests.	75-A.4(a)(1)
		Septic tank aggregate bedding criteria.	75-A.6(b)(1)(vii)
		Distribution box aggregate bedding criteria	75-A.7(a)(1)(iii)
		Seepage pit annular ring aggregate criteria.	75-A.8(h)(3)(iii)
		Downstream mound design criteria.	75-A.9(d)(3)(x) & 75-A.9(d)(4)(viii)
		Interim procedure for on-site system design	75-A.8(g) & 75-A.8(h)
		Modified absorption test for sand-filled shaft.	75-A.4(c) & 75-A.4(d)
	1992	Modified seepage pit design criteria.	75-A.8(h)
New York City Department of Environmental Protection (NYCDEP)		Modified separation requirements between absorption facilities and front property line and drywells and building foundation/property lines.	75-A.4(b)
		Modified separation requirements between septic tank and front property line.	75-A.4(b)
		Subsurface sand filtration treatment for partially saturated sand-filled shaft.	75-A.9(d)

NOTE:

Some Statewide general waivers that were listed in the 1996 edition of the Design Handbook have since been incorporated into the current edition of Appendix 75-A and are therefore no longer necessary and have been removed from the list.

TABLE 11

EVALUATING AND CORRECTING SYSTEM FAILURE

CAUSE	POOR SITING, DESIGN and/or CONSTRUCTION	SYSTEM OVERLOADING	MAINTENANCE
EVALUATE	Soil Percolation (re-test) Unsaturated Soil Depth (re-test) Surface Grading (away from system) Depth to High Ground Water Wastewater Flow (gpd) Septic Tank Baffle(s) Septic Tank size Absorption field size Distribution Box or Drop Box Infiltration (ground or surface water) Trenches Parallel to Contours Trench depth Trenches level Trenches of Equal Length Conditions of Neighboring Systems	Plumbing (fixtures/toilets type) Plumbing (leaks) Plumbing (water treatment system) Plumbing (sump pump) Wastewater Characteristics (grease, garbage grinder) Excess inhabitants Home Business discharges Home Hobby discharges	Maintenance Records (septic tank pumping or ETU) Conditions of Septic Tank Condition of Distribution Box or Drop Box Condition of Field (ruts, structures, vegetation/trees) System Age System repairs or upgrades House sewer drain and vents
CORRECTION	Surface Water Diversion (Regrading, Filling, ditching,) Ground Water control/diversion (Curtain Drains, etc.) Eliminate System Deficiencies Increase Septic Tank capacity Increase Absorption System Size Provide Dosing Redesign & Replace System Use ETU or other technology	Repair or replace plumbing (Install Water Saving Fixtures/toilets) Eliminate Clear Water Discharges (sump pump, water treatment discharge) Eliminate infiltration (watertight components) Eliminate Improper Waste Discharges (Oil, Grease, garbage grinder, etc) Reduce High Rate Discharges (Spa/Hot Tub Draining) Improve septic performance (effluent filter, gas baffle, Multi-Tank) Redesign & Replace System Use ETU or other technology	Pump Septic Tank Eliminate System Deficiencies Surface Water Diversion (Regrading, Filling) Ground Water Diversion (Curtain Drains, etc.) Increase System Size Periodically Rest Absorption Trenches (adjust distribution levelers) Check dosing float settings Re-design & Replace System Use ETU or other technology

TABLE 12 - USDA SOIL TEXTURE CLASSIFICATION GRAPH

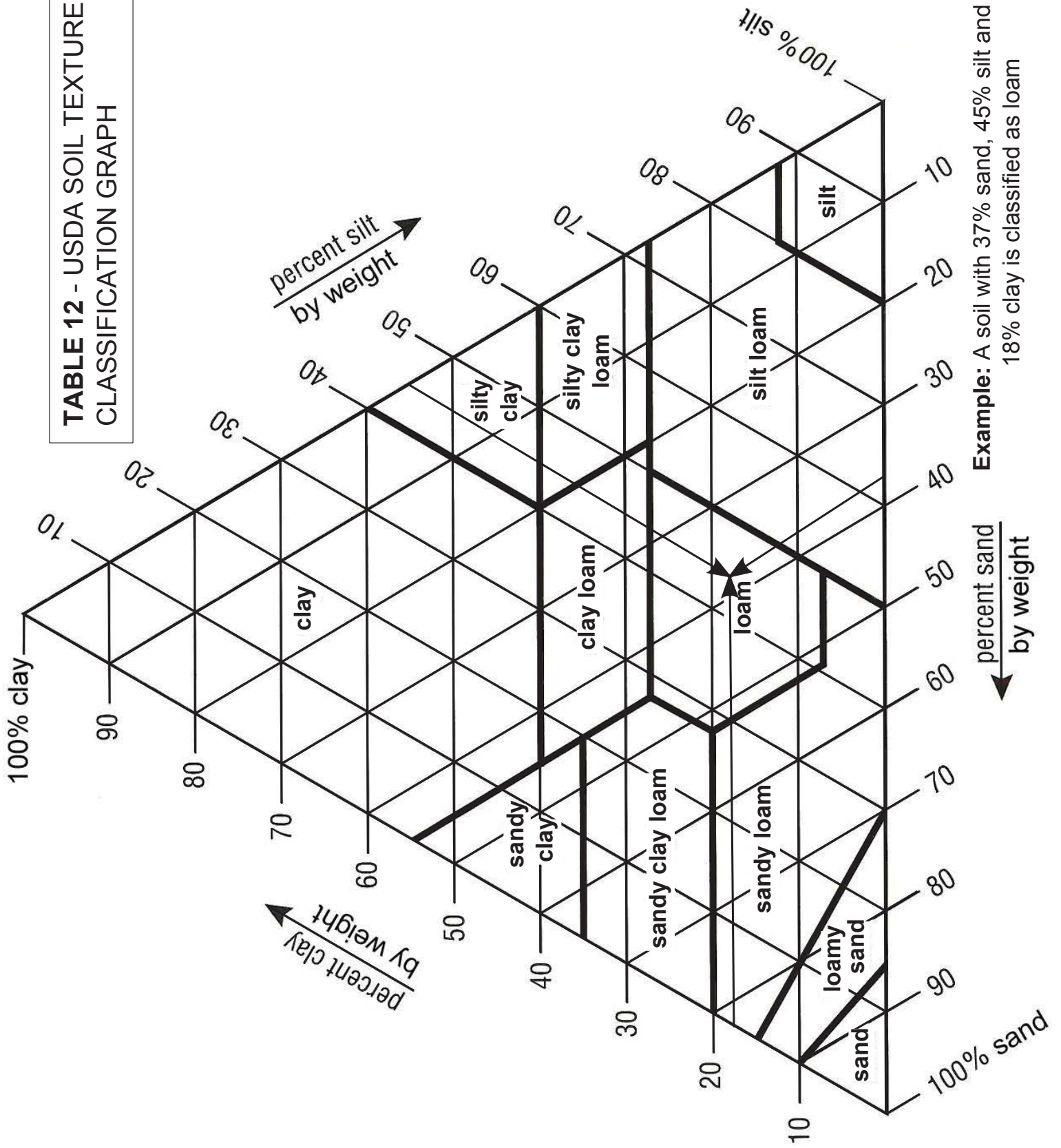

GLOSSARY (DEFINITIONS)

(g) *Soil Tests and Soil Samples*

The test in each case should be made by first digging a hole 1 foot square and 18 inches deep (the depth of the tile trenches) and then filling the hole with water to a depth of 6 inches. The downward rate of percolation or drop of water surface should then be observed taking the average time in minutes for the water surface to lower 1 inch in the hole.

In the case of *leaching cesspools* the test hole should be dug in the bottom of a pit excavated to a depth of about one-half the proposed depth of the cesspool.

To eliminate the effect of a dry soil the test should be repeated and the slower rate of percolation used. With this information, the rate at which the sewage may be applied to the total superficial bottom area of the trenches in which the tile is laid or the superficial percolating area of the cesspools may be taken from the following table:

Time for water to fall 1 inch	Allowable rate of sewage application per sq. ft. per day	
	Bottom Area Trenches	Percolating Area Cesspools
1 minute	4.0 gallons	5.3 gallons
2 minutes	3.2 gallons	4.3 gallons
5 minutes	2.4 gallons	3.2 gallons
10 minutes	1.7 gallons	2.3 gallons
30 minutes	0.8 gallons	1.1 gallons
60 minutes	0.6 gallons	0.8 gallons

“Rules and Regulations for the Preparation and Submission of Plans for Systems of Sewerage and Sewage and Waste Disposal”

NYSDOH
1932

This text is for historical interest only. Do not use for plan or design preparation.

Glossary (Definitions)

Absorption Area or Absorption Field - an area to which wastewater effluent is distributed for infiltration into the soil.

Absorption Bed - an absorption area comprised of a single shallow excavation, not more than 20 feet wide, that includes several distribution laterals for the distribution of wastewater effluent.

Absorption Trench - an absorption area comprised of long, narrow and shallow excavation(s) for the distribution of wastewater effluent.

Aeration - the process of transferring oxygen to wastewater treatment components or absorption areas through piping, diffusers, air source, vents or other devices.

Aggregate - washed gravel or crushed stone $\frac{3}{4}$ to $1\frac{1}{2}$ inches in diameter for absorption trench. Number 2 stone or gravel is an acceptable option. Large washed gravel or crushed stone $2\frac{1}{2}$ to 4 inches in diameter is used for seepage pit annular ring.

Alternate Aggregate - Materials used as a substitute for conventional gravel or crushed stone aggregate when it can be demonstrated that the material provides at least the equivalent soil infiltration area and storage volume as conventional gravel or crushed stone aggregate. Materials shall also maintain structural integrity and be non-degradable by wastewater effluent.

Application Rate - the rate at which wastewater effluent is applied to a subsurface absorption area expressed in gallons per day per square foot (gpd/ft²) for design purposes.

Baffle - a flow deflecting device used in septic tanks, distribution boxes and drop boxes to inhibit the discharge of floating solids, reduce the amount of settleable solids that exit the component and reduce the exit velocity of the wastewater.

Biochemical oxygen demand (BOD) - A commonly used gross measurement of the concentration of biodegradable organic matter in wastewater. The amount of oxygen, expressed in milligrams per liter (mg/L), required by bacteria to digest organic matter under aerobic conditions.

Biomat - a layer of biological growth and inorganic residue that develops at the infiltrative surface.

Cleanout - an opening providing access to wastewater treatment system components including the house sewer drain, distribution piping, distribution box, drop box and septic tank.

Curtain Drain/Perimeter and Interceptor Drain/French Drain - a subsurface drain designed and constructed to control ground water intrusion into the wastewater treatment system or sewer.

Design Professional - a person licensed and or registered in the State of New York as an Engineer (PE) or Architect (RA) and authorized by the State Education Law in accordance with Article 145 or 147, respectfully, and acting within the scope of his or her practice to design the systems described in 10 NYCRR Appendix 75-A.

Distribution Device - a device used to uniformly distribute wastewater effluent to the absorption area or filtration area.

Distribution Line - the perforated pipe used to distribute wastewater effluent in the absorption area or filtration area.

Diversion Ditch or Berm - a designed and constructed excavation or filled area to control surface water intrusion into the wastewater absorption area on sloped sites.

Drinking Water - water whose physical, chemical, radiological, and biological quality is or is intended to be satisfactory for human consumption, food preparation or culinary purposes (i.e., conforms with Part 5 of the State Sanitary Code titled, "Drinking Water Supplies").

Effective Grain Size - a measure of the diameter of soil particles, when compared to a theoretical material having an equal transmission constant. It is the dimensions of that mesh screen which will permit 10% of the sample to pass and will retain 90 percent.

Effluent - wastewater discharged from a system component or device such as a septic tank, ETU, dosing tank, distribution box or drop box.

Enhanced Treatment - The biological and physical treatment of wastewater to reduce the amount of biological oxygen demand (BOD) and total suspended solids (TSS) of wastewater effluent prior to distribution to an absorption area.

Enhanced Treatment Unit (ETU) - Pre-manufactured structures that provide enhanced treatment of wastewater prior to discharge to a subsurface soil absorption area.

Gas Baffle – a device on the outlet of a septic tank that deflects gas bubbles away from the outlet and reduces the carryover of solid particles from the septic tank.

Greywater - all wastewater from a house except from flush toilets and urinals.

Ground Water - subsurface water occupying the saturation zone from which wells and springs are fed (i.e., water below the ground water table).

Heavy Equipment - all equipment that would result in the compaction of the design absorption area at a depth equivalent to the design depth of the distribution lines. Examples include backhoe, bulldozer and dump truck.

House Sewer Drain - lowest piping in the household drainage system that collects the discharge from all other drainage piping in the house, extends three (3) feet outside the building wall, and connects to the house sewer drain line.

House Sewer Drain Line - the line that connects to the end of the house sewer drain and conveys wastewater to the first wastewater treatment system component (i.e., septic tank or ETU) or the public sewer main.

Infiltration - the flow or movement of water into the interstices or pores of a soil through the soil interface.

Invert - the floor, bottom, or lowest point of the inside cross-section of a pipe or opening/slot/channel (i.e., flow opening between compartments in a multi-compartment septic tank).

Large Aggregate - washed gravel or crushed stone $\frac{3}{4}$ to 2 $\frac{1}{2}$ inches in diameter. Number 3A and 3 stone or gravel meets this size requirement and Number 3 is preferred.

Local Health Department - a city, county or part-county department of health or a State Department of Health District Office.

Pea Gravel - washed gravel or crushed stone $\frac{1}{8}$ to $\frac{1}{4}$ inch in diameter. Number 1B stone or gravel meets this size requirement.

Percolation - the movement of water through the pores of a soil or other porous medium following infiltration through the soil interface.

Permeability - a measure of the rate of movement of liquid through soil.

Rain Garden - a planted depression that allows rainwater runoff from impervious areas like roofs, driveways, walkways, parking lots, and compacted lawn areas the opportunity to be absorbed.

Responsible Management Entity (RME) - A legal entity with the requisite managerial, financial and technical capacity to ensure long-term management of residential wastewater treatment systems. RME's may include: sewer districts, utilities, municipal authorities or other entities with the authority to enforce and the capacity to finance the long-term operation and maintenance requirements necessary to ensure residential wastewater treatment systems are functioning properly.

Scum - the wastewater material which is less dense than water and floats on top of the water (i.e., especially in septic tanks).

Sewage - the combination of human and household waste with water which is discharged to the

home plumbing system including the waste from a flush toilet, bath, shower, sink, lavatory, dishwashing or laundry machine, or the water-carried waste from any other fixture, equipment or machine.

Sludge - the wastewater material which is more dense than water and settles to the bottom in relatively quiescent areas (i.e., especially in septic tanks).

Stabilized Rate of Percolation - the rate corresponding to two (2) consecutive equal or near equal percolation test results.

Stream - is a watercourse or portion of a watercourse, including the bed and banks, as mapped or determined by NYSDEC. Drainage areas, which contain water only during and immediately following precipitation or snowmelt, should not be considered a stream.

Tire Derived Aggregate (TDA) - aggregate manufactured (i.e., chipped) from waste tires to a similar size distribution as conventional gravel or stone aggregate and used as an alternative to gravel or stone aggregate in soil absorption areas.

Total Suspended Solids (TSS) - measure of all suspended solids in a liquid, typically expressed in mg/L.

Uniformity Coefficient - a ratio of the diameter of soil particles obtained by sieving soil through standard U.S. Sieve Series meshes and dividing the mesh size of the sieve opening at which 60% of the particles pass through and 40% is retained by the mesh size of the sieve opening at which 10% of the particles pass through and 90% is retained; U.C. equals D_{60}/D_{10} .

Useable Soil - unless otherwise stated, a soil with a percolation rate of one (1) to sixty (60) minutes per inch with a compatible soil classification.

Wastewater - any water discharged from a house through a plumbing fixture to include, but not be limited to, sewage and any water or wastewater from a device (e.g., water softener brine or garbage grinder waste) which is produced at the house or property.

Watercourse - an area of land within which or upon which the flow of water is ordinarily confined due to existing topography such as a lake, pond, river or stream. Drainage areas, which contain water only during and immediately following precipitation or snowmelt, should not be considered a watercourse.

Watershed - a geographic area which drains to a common low point or body of water which may also serve as a source of drinking water and for which watershed rules and regulations have been adopted by the Commissioner.

Watershed Protection Agency (WPA) - an official entity charged with protecting a body of water that may also serve as a source of drinking water and for which the Commissioner has adopted watershed rules and regulations.

Well Head Area - the area surrounding a well which includes the cone of influence (i.e., where the drawdown of ground water causes ground water flow).

Wetland - an area of marshes or swamps which have been designated as such by the NYSDEC or other State agency (e.g., Adirondack Park Agency) having jurisdiction. Marshes or swamps that have not been so classified should not be treated as a wetland for design purposes.

This page intentionally left Blank

REFERENCES AND WEBSITES

Analysis of Sewage

Typical:- parts per million

Solids, total.	506.5	700.0
Suspended	180.6	400.0
Volatile	149.4	
Dissolved	325.9	300.0
Volatile	126.4	
O consumed	66.6	40.0
N as		
Free Am	26.0	25.0
Alb. Am	5.6	10.0
Nitrites		.005
Nitrates		.100
Chlorine	60.3	40.0
Bacteria	3000000	2000000
B. coli	500000	400000

6 gm. per cap per day = p.p.m. X
0.38 with flow of 100 g.p.c.p.d.

Sewage contains 45-50 lbs
dry solids per capita per year.

Average B-C. O.D = 125-200 p.p.m.
= 0.15-0.20 lbs per capita per day

Average pH = 6.9 - 7.4

H. RYON Analysis of Sewage.

Cesspool Rates

Time fall to	Gal. per sq. ft. day	Safe g. sq. ft. day	Safe number of p. cap.		
			School	Factory	Dwelling
15 Sec.	4000	6.0	3.3	4.1	13.0
15 "	3200	5.8	3.4	4.2	13.5
20 "	2700	5.7	3.5	4.4	14.0
25 "	2150	5.5	3.6	4.5	14.5
30 "	1800	5.4	3.7	4.6	15.0
45 "	1200	5.1	3.9	4.9	15.5
1 Min.	897	4.9	4.1	5.1	16.5
1½ "	600	4.7	4.2	5.2	17.0
2 "	450	4.4	4.5	5.6	18.0
2½ "	360	4.2	4.7	5.9	19.0
3 "	300	4.0	5.0	6.3	20.0
3½ "	250	3.7	5.4	6.8	21.5
4 "	220	3.6	5.5	6.9	22.0
5 "	180	3.3	6.0	7.5	24.0
7 "	130	3.0	6.7	8.4	27.0
10 "	90	2.5	8.0	10.0	32.0
15 "	60	2.1	9.5	12.0	38.0
20 "	45	1.7	12.0	16.0	48.0
30 "	30	1.3	16.0	20.0	64.0
45 "	20	1.0	20.0	25.0	80.0
1 Hr.	15	0.6	30.0	33.0	120.0
1½ "	10	0.4	50.0	63.0	200.0
2 "	7½	0.3	65.0	81.0	250.0
3 "	5	0.2	100.0	125.0	400.0
5 "	3	0.1	200.0	250.0	600.0
10 "	1½	0.05	400.0	500.0	1600.0

For explanation see notes
on sub-surface irrigation.
For cesspools of average depth ± 6'

H. RYON Cesspool Rates

“Notes on Sanitary Engineering , Hydraulics, sewerage, sewage disposal,
water supply”

Henry Ryon

1924

This table and text is for historical interest only. Do not use for plan or design preparation.

References and Websites

The following represents a partial list of those documents, publications and websites most influential to development of this Design Handbook.

- 1) 10 NYCRR Part 75, "Standards for Individual Water Supply and Individual Sewage Treatment Systems," December 1, 1990.
- 2) 10 NYCRR Appendix 75-A, "Wastewater Treatment Standards - Residential Onsite Systems", February 3, 2010.
- 3) 10 NYCRR Appendix 5-B, "Standards for Water Well", November 23, 2005.
- 4) 10 NYCRR Appendix 5-D, "Special Requirements for Wells Serving Public Water Systems", November 23, 2005
- 5) NYSDOH "Individual Residential Wastewater Treatment Systems - Design Handbook", 1996.
- 6) USEPA, "Onsite Wastewater Treatment Systems Manual", Publication EPA/625/R-00/008, February 2002.
- 7) USEPA, "Voluntary National Guidelines for Management of Onsite and Clustered Decentralized Wastewater Treatment Systems", Publication EPA 832-B-03-001, March 2003.
- 8) NYSDEC, "Design Standards for Wastewater Treatment Works, Intermediate Sized Sewerage Facilities", 1988.
- 9) Great Lakes Upper Mississippi River Board (GLUMRB) of State Public Health and Environmental Managers, Recommended Standards for Wastewater Facilities, 2004 Edition.
- 10) Great Lakes Upper Mississippi River Board (GLUMRB) of State Public Health and Environmental Managers, Recommended Standards for Water Works, 2007 Edition
- 11) Salvato, Joseph A., Jr., Environmental Engineering and Sanitation, Wiley Interscience, New York, 1972.
- 12) "Drainage Guide for New York State," U.S. Department of Agriculture Soil Conservation Service, September 1987.
- 13) "Drainage of Agriculture Land," U.S. Department of Agriculture Soil Conservation Service, Water Information Center, Inc., 1973.

Selected Useful Websites:

United States Environmental Protection Agency (USEPA): <http://cfpub.epa.gov/owm/septic/index.cfm>

National Environmental Services Center (NESC): <http://www.nesc.wvu.edu/wastewater.cfm>

NSF International (NSF): <http://www.nsf.org/>

National Onsite Wastewater Recycling Association (NOWRA): <http://www.nowra.org/index.html>

FOREWORD.

The laws of New York State require that when sewage is disposed of into the waters (including tidal waters) or ground waters of the state, plans shall be submitted to the State Engineer for approval and a permit for the discharge of the sewage obtained from the State Commissioner of Health. Detailed rules and regulations regarding the submission of such plans are issued by the State Engineer.

Time for water to fall 1 inch.	Length of tile or square feet per person required.	Day schools & factories (no restaurants)
	Dwellings, etc.	
10 seconds	15 feet	3.7 feet
15 "	16 "	4.0 "
20 "	17 "	4.2 "
25 "	19 "	4.7 "
30 "	20 "	5.0 "
45 "	22 "	5.5 "
1 minute	24 "	6.0 "
2 "	26 "	6.5 "
3 "	29 "	7.2 "
4 "	33 "	8.0 "
5 "	36 "	9.0 "
10 "	48 "	12.0 "
15 "	57 "	14.0 "
30 "	96 "	24.0 "
45 "	120 "	30.0 "
1 hour	180 "	45.0 "

The temperature has some effect on this test but for the ordinary temperatures of soil and water, about 50°F, it is sufficiently accurate for practical purposes. The test should not, however, be made in a hole that has been exposed for some time to a hot summer sun or should hot water be used or the resulting length of tile indicated by the table will be too small. Neither should the test be made in frozen soil or with ice water or the result will indicate an unnecessary length of tile.

“Notes on The Design of Sewage Disposal Works with special reference to
Small Installations”

Henry Ryon

1924

This text and table is for historical interest only. Do not use for plan or design preparation.

APPENDICES

This page intentionally left Blank

Appendix A

Design of Mound Systems and Pressure Distribution Networks

Includes:

Part 1	
Design of A Mound System Using Absorption Trenches.....	A-1
Mound Dimension Calculations	A-1
Distribution Network Calculations	A-3
Part 2	
Design of A Mound System Using An Absorption Bed.....	A-5
Mound Dimension Calculations	A-5
Distribution Network Calculations	A-7
Tables	
A-1. Recommended Pressure Pipe Diameters For Various Diameters, Orifice Spacings, and Maximum Lateral Lengths	
Orifice Size =1/4 Inch.....	A-10
Orifice Size =5/16 Inch.....	A-11
Orifice Size =3/8 Inch.....	A-12
Orifice Size =7/16 Inch.....	A-13
Orifice Size =1/2 Inch.....	A-14
A-2. Recommended Manifold Sizes For Pressure Distribution Networks	
6 feet Center - to - Center Spacing Between Trenches	A-15
A-3. Recommended Manifold Sizes For Pressure Distribution Networks 6 feet Center to Center Spacing Between Trenches	
5 feet Center - to - Center Spacing Between Laterals in Absorption Beds.....	A-16
A-4. Discharge Rates For Various Sized Holes At Various Sized Holes at Various Pressures (GPM)	
Based On Orifice Equation, $C = 0.6$	A-17

This page intentionally left Blank

APPENDIX A
Part 1
DESIGN OF A MOUND SYSTEM USING ABSORPTION TRENCHES

Example: Design a mound for a 4 bedroom house with the following site conditions:

Natural soil texture..... Silt loam
Percolation rate at 12 inch depth 85 min./inch
Depth to seasonally high water table..... 14 inches
Slope..... 7%
Bedrockencountered at 30 inches depth.

Note: Site requirements in Section 75-A-9(c)(2) of Appendix 75-A and the horizontal and vertical separation distances as described in **Figure 30, Table 2** and **Table 4** of this Handbook must be met in order to construct a mound system.

MOUND DIMENSION CALCULATIONS

Step 1: Select the Site. The mound site should be selected prior to locating the house, well, driveway, pool or any other site features. Consider all possible mound locations on the lot and the difficulties in construction of the mound at the various locations.

Step 2: Select Suitable Fill Material. Fill material chosen for the mound must comply with Section 75-A.9(c)(3)(iii) of Appendix 75-A. As such, only soils with a percolation rate between 5 and 30 minutes per inch shall be used for the fill material. Assume a medium texture sand for the fill with a percolation rate of 26 min./in. as measured at the borrow pit. In accordance with **Table 6A or 6B** of this Handbook, the required length of absorption trenches to be constructed is 367 feet.

Step 3: Estimate Design Flow. Design flow is estimated from the number of bedrooms in the house. In this instance, 110 gpd/bedroom is assumed due to the use of low flow fixtures.

$$\text{Design Flow} = (4 \text{ bedrooms}) \times (110 \text{ gpd/bedroom}) = 440 \text{ gpd}$$

Step 4: Size Absorption Trenches.

$$\text{Total length of trenches} = 367 \text{ ft.}$$

Use 8 trenches with central manifold distribution (4 trenches on each side of the manifold.)

Step 5: Calculate Dimensions of the Absorption Area. The absorption trenches must be installed parallel to the site contours. In this example, there will be four (4), 46 ft. long trenches on each side of a central supply manifold.

$$\text{Absorption Area Width (A)} = 4 \text{ trenches @ } 2 \text{ ft wide/trench} + 12 \text{ ft total trench separation} = 20 \text{ ft.}$$

$$\text{Absorption Area Length (B)} = 2 \times 46 \text{ ft.} = 92 \text{ ft.}$$

Step 6: Calculate Mound Dimensions. Refer to **Figures 30A, 32** and **32A** of the Handbook.

- a. Mound Height =
 - Fill Depth (D) = 1 ft. (minimum)
 - Fill Depth (E) = D + [Slope x A]
 - = 1 ft. + [0.07 x 20]
 - = 2.4 ft.

Bed Depth (F) = 9 in. (minimum). (A minimum of 6 in. must be below the inverts of the distribution laterals and a minimum of 2 in. above the distribution laterals. Since the smallest distribution lateral allowed is 1 in. diameter, the minimum bed depth allowed is 9 in.)

Cap at Edge of Trenches (G) = 1 ft. (minimum)

Cap at Center of Trenches (H) = 1.5 ft. (minimum)

b. Mound Perimeter (Refer to **Figures 30A** and **32** of the Handbook.)

Upslope Setback (J) = (mound height at upslope edge of trenches) x (3:1 slope)
= [D + F + G] x 3
= [1.0 + 0.75 + 1.0] x 3
= 8.25 ft. (This will be less because of natural ground slope, use 8 ft.)

Side Slope Setback (K) = (mound height at downslope edge of trenches) x (3:1 slope)
= (E + F + G) x 3
= 11.9 or 12 ft.

Mound Length (L) = B + 2(K) = 92 + (2 x 12)
= 116 ft.

Downslope Setback (C): In accordance with Section 75-A.9(c)(3)(ii) of Appendix 75-A, on a sloping site, the basal area of a mound includes only the area under the absorption trenches/bed and the lower or downhill taper. The basal area required must be used to calculate the downslope setback (C) to ensure adequate basal area for the mound. The design infiltration rate to the existing in-situ soil with an 85 min./inch percolation rate is 0.2 gpd/ft².

The required basal area (BAR) is:

$$\text{BAR} = (440 \text{ gpd}) / (0.2 \text{ gpd/ft}^2) = 2,200 \text{ ft}^2$$

$$\text{BAR} = \left[\left(\frac{B+L}{2} \right) \times C \right] + (A \times B)$$

Solving for C:

$$2,200 = \left[\left(\frac{92+116}{2} \right) \times C \right] + (20 \times 92)$$

$$C = 3.5 \text{ ft. or } 4 \text{ ft.}$$

Check to see that the downslope setback is great enough so as not to exceed a 3:1 slope:

$$\text{Downslope Setback (C)} = 3 \times [(E + F + G) + (\text{natural slope} \times C)]$$

$$C = 3 \times [(2.4 + 0.75 + 1.0) + (0.07 \times C)]$$

$$0.33C = 3.95 + 0.07C$$

$$C = 15.9 \text{ ft. or } 16 \text{ ft.}$$

Since the distance needed to maintain a 3:1 slope is greater than the distance needed to provide sufficient basal area, C = 16 ft.

$$\text{Mound Width (W)} = J + A + C = 8 + 20 + 16 = \underline{44 \text{ ft.}}$$

Mound basal dimensions are: Length (L) = 116 ft. and Width (W) = 44 ft.

DISTRIBUTION NETWORK CALCULATIONS

Design a pressure distribution network for the mound that will ensure equal wastewater application (i.e., minimizes distribution network headloss.)

In accordance with Section 75-A.9(c)(3)(vi) of Appendix 75-A, a pressure distribution network is required for a mound system.

Step 1: Select Lateral Length. A lateral length of 45 feet is chosen for this system figuring laterals will extend to within 1 foot of the ends of aggregate filled trenches.

Step 2: Select Hole Diameter and Hole Spacing for Laterals. For this system, 1/4 in. diameter holes spaced every 4 ft. are used, although other combinations could be chosen.

Step 3: Select Lateral Diameter. For 1/4 in. hole diameter, 4 ft. hole spacing, and 45 ft. lateral length, Table A-1, page 1 of 5, of Appendix A indicates approximately that a 1-1/2 in. diameter lateral could be used. 1-3/4 in. diameter pipe is selected for this example to provide for future expansion, if required.

Step 4: Calculate Lateral Discharge Rate. A minimum 2.3 ft. head must be maintained in the lateral.

Using the orifice equation, the discharge rate for a 1/4 inch hole at 2.3 feet minimum pressure is calculated:

$$Q = CA(2gh)^{1/2} \text{ where } C = 0.6 \text{ (orifice coefficient for sharp-edged orifice)}$$

$g = \text{gravity constant} = 32.2 \text{ ft/sec}^2$
 $h = \text{head in feet}$
 $A = \text{area of orifice in feet}^2$

$$Q = 0.6 \times (3.14 \times 10^{-4} \text{ ft}^2) \times (2 \times 32.2 \text{ ft/sec}^2 \times 2.3 \text{ ft})^{1/2}$$
$$Q = 2.49 \times 10^{-3} \text{ ft}^3/\text{sec} \times 7.48 \text{ gal./ft}^3 \times 60 \text{ sec./min.} = 1.11 \text{ gpm/orifice}$$

(Assume this flow out each orifice. This is approximate, as changes in head between distal and supply orifices will not exceed 10% maximum, affecting Q by $\sqrt{10\%}$ or less than 3.5%)

$$\begin{aligned} \text{Number of holes per lateral} &= 45 \text{ ft. lateral length} / 4.0 \text{ ft. hole spacing} \\ &= 11.25 \text{ or } 12 \end{aligned}$$

$$\begin{aligned} \text{Lateral discharge rate} &= 12 \text{ holes/lateral} \times 1.11 \text{ gpm/hole} \\ &= 13.32 \text{ gpm/lateral} \end{aligned}$$

Step 5: Select Manifold Size. There are to be 8 laterals (4 on either side of the central manifold) spaced 6 feet apart. The manifold length will be 18 feet. For 8 laterals at 13.32 gpm/lateral, **Table A-2** of Appendix A indicates that a minimum 3.0 inch diameter manifold may be used. The 3.00 inch diameter manifold is selected for this example to provide for future system expansion if required.

Step 6: Determine Minimum Dose Volume. Dosing volume should be at least ten times the total distribution lateral pipe volume to minimize differences in discharge volumes from the supply end and distal end orifices during filling.

$$\begin{aligned} \text{Total lateral volume} &= 8 \times 45 \text{ ft} \times (1.75/12)^2 \times (\pi/4) \times 7.48 \text{ gal/ft}^3 \\ &= 45.0 \text{ gal} \end{aligned}$$

$$\text{Minimum dose} = 10 \times 45 \text{ gal.} = 450 \text{ gal/dose}$$

A minimum dosing frequency of 3 doses/day is recommended for a sand or loam type soil. This should be similar to the type of soil that comprises the fill material of the mound. This frequency cannot be achieved given the site and piping constraints of this example. Therefore, the dosing frequency will be:

$$\text{Dosing frequency} = \frac{440 \text{ gpd}}{450 \text{ gal/dose}} = 0.98 \text{ doses/day or } \underline{1 \text{ dose/day}}$$

Step 7: Determine Minimum Discharge Rate.

$$\begin{aligned} \text{Minimum Discharge Rate} &= (8 \text{ laterals}) \times (13.32 \text{ gpm/lateral}) \\ &= 106.6 \text{ gpm or } \underline{107 \text{ gpm}} \end{aligned}$$

Step 8: Select Proper Pump. For this example, assume the dosing tank is located 50 ft. from the network inlet, the difference in elevation between the pump and the inverts of the distribution laterals is 6 ft., and a 2 in. diameter delivery pipe is to be used.

Friction loss in 50 ft. of 2 in. pipe at 107 gpm (0.24 cfs) using the Hazen-Williams equation:

$$\begin{aligned} h_f &= (4.727/D^{4.87})(L)(Q/C)^{1.85} \\ h_f &= (4.727/(2.0/12)^{4.87})(50)(0.24/150)^{1.85} \\ h_f &= 9.8 \text{ ft.} \end{aligned}$$

$$\text{Elevation Head} = 6.0 \text{ ft.}$$

$$\text{Pressured head to be maintained} = \underline{2.3 \text{ ft.}}$$

$$\text{Total Pumping Head} = \underline{18.1 \text{ ft.}}$$

Therefore; a pump capable of delivering at least 107 gpm against 18.1 ft. of head is required.

If the delivery pipe to the mound is set to drain back to the pump station due to site constraints or because it must be located above the frost line, the volume of wastewater occupying the pipe after the pump cycle has finished must be considered. In cases where the delivery pipe is of considerable length and/or diameter, a substantial amount of wastewater will drain back to the pump station following completion of the pump cycle. The storage capacity of the pump station must be designed to accommodate the extra volume of wastewater flowing back to the pump station so that it is recycled with each pump cycle and the design dose to the mound is maintained.

In summary; the final network design consists of eight 45 feet laterals with a 1.75 inch diameter (four on each side of a 3 inch diameter central manifold.) The inverts of the laterals are perforated with 1/4 inch holes spaced every 4 feet.

APPENDIX A
Part 2
DESIGN OF MOUND SYSTEM USING AN ABSORPTION BED

Example: Design a mound for a 4 bedroom house with the following site conditions:

Natural soil texture.....Clay loam
 Percolation rate at 12 inch depth90 min./inch
 Depth to seasonally high water table.....12 inches
 Slope.....6%
 Bedrock.....None encountered

NOTE: Site requirements in Section 75-A-9(c)(2) of Appendix 75-A and the horizontal and vertical separation distances as described in **Figures 31, Table 2** and **Table 4** of the Handbook must be met in order to construct a mound system.

MOUND DIMENSION CALCULATIONS

Step 1: Select the site. The mound site should be selected prior to locating the house, well, driveway, pool, or any other site features. Consider all possible mound locations on the lot and the difficulties in construction of the mound at the various locations.

Step 2: Select Suitable Fill Material. Fill material chosen for the mound must comply with Section 75-A.9(c)(3)(iii) of Appendix 75-A. As such, only soils with a percolation rate between 5 and 30 minutes per inch shall be used for the fill material. Assume a medium texture sand for the fill with a percolation rate of 14 min./inch as measured at the borrow pit. In accordance with **Table 7A or 7B** of the Handbook, the design infiltration rate is 0.6 gpd/ft².

Step 3: Estimate Design Flow. Design flow is estimated from the number of bedrooms in the house. In this instance, 110 gpd/bedroom is assumed due to the use of low flow fixtures.

$$\text{Design Flow} = (4 \text{ bedrooms}) \times (110 \text{ gpd/bedroom}) = 440 \text{ gpd}$$

Step 4: Size Absorption Area.

$$\text{Absorption Bed Area} = \frac{440 \text{ gpd}}{0.6 \text{ gpd / ft}^2} = 733 \text{ ft}^2$$

Step 5: Calculate Absorption Bed Dimension. The bed must parallel the site contour. In this example, assume the bed width will be 10 feet. The maximum width allowed by Section 75-A.9(c)(3)(iv) of Appendix 75-A is 20 ft. As such, this would leave 10 feet for future expansion without the need to construct an additional separate mound.

$$\text{Bed Width (A)} = \frac{\text{Absorption Bed Area}}{\text{Bed Length (B)}}$$

$$10 \text{ ft.} = \frac{733 \text{ ft.}^2}{B}; \quad B = 73.3 \text{ ft. or } 74 \text{ ft.}$$

$$\text{Bed dimensions: } A = 10 \text{ feet and } B = 74 \text{ feet}$$

Step 6: Calculate Mound Dimensions. Refer to **Figure 31** of the Handbook.

a. Mound Height

$$\begin{aligned}
\text{Fill Depth (D)} &= 1 \text{ ft. (minimum)} \\
\text{Fill Depth (E)} &= D + [(\text{Slope}) \times (A)] \\
&= 1 \text{ ft.} + [(0.06 \times 10)] \\
&= 1.6 \text{ feet. (This is only approximate. Critical} \\
&\quad \text{factor is construction of level bed bottom.}
\end{aligned}$$

$$\begin{aligned}
\text{Bed Depth (F)} &= 9 \text{ in. (minimum). (A minimum of 6 in. must be below the inverts of the} \\
&\quad \text{distribution laterals and a minimum of 2 in. above the distribution laterals. Since} \\
&\quad \text{the smallest distribution lateral allowed is 1 in. diameter, the minimum bed depth} \\
&\quad \text{allowed is 9 in.)}
\end{aligned}$$

$$\text{Cap at Edge of Bed (G)} = 1 \text{ ft. (minimum)}$$

$$\text{Cap at Center of Bed (H)} = 1.5 \text{ ft. (minimum)}$$

b. Mound Perimeter (Refer to **Figures 31A and 32** of the Handbook.)

Downslope Setback (C): In accordance with Section 75-A.9(c)(3)(ii) of Appendix 75-A, on a sloping site, the basal area of a mound includes only the area under the absorption trenches/bed and the lower or downhill taper. The basal area is designed upon the percolation rate of the naturally occurring soil. For soils of 61 – 120 min./in., a rate of 0.2 gpd/ft² shall be used for determining the minimum basal area required.

$$\begin{aligned}
\text{Upslope Setback (J)} &= (\text{mound height at upslope edge of bed}) \times (3:1 \text{ slope}) \\
&= [(D) + (F) + (G)] \times (3) \\
&= [(1.0) + (0.75) + (1.0)] \times (3) \\
&= [2.75] \times (3) \\
&= 8.25 \text{ ft. (This will be less because of natural ground slope. Use 8ft.)}
\end{aligned}$$

$$\begin{aligned}
\text{Side Slope Setback (K)} &= (\text{mound height at bed center}) \times (3:1 \text{ slope}) \\
&= \left[\frac{(D) + (E)}{2} + (F) + (H) \right] \times (3) \\
&= \left[\frac{(1.0) + (1.6)}{2} + (0.75) + (1.5) \right] \times (3) \\
&= [3.55] \times (3) \\
&= 10.65 \text{ ft. or 11 ft.}
\end{aligned}$$

$$\begin{aligned}
\text{Mound Length (L)} &= (B) + 2(K) \\
&= (74) + 2(11) \\
&= 96 \text{ ft.}
\end{aligned}$$

$$\text{Basal Area Required} = \left[\frac{(B + L)}{2} \times (C) + (A \times B) \right]$$

In accordance with Section 75-A.9(c)(3)(ii) of Appendix 75-A, the design infiltration rate is 0.2 gpd/ft² due to the in-situ permeability of the underlying native soil.

The required basal area is:

$$\text{BAR} = \frac{440 \text{ gpd}}{0.2 \text{ gpd / ft}^2} = 2,200 \text{ ft}^2$$

Solving for downslope setback (C):

$$2,200 = \left[\frac{(B+L)}{2} \times (C) + (A \times B) \right]$$

$$2,200 = \left[\frac{(74+96)}{2} \times (C) + (10 \times 74) \right]$$

$$2,200 = [(85) \times (C) + (740)]$$

$$(C) = 17.2 \text{ ft. or } \underline{18 \text{ ft.}}$$

Check to see that the downslope setback (C) is great enough so as not to exceed a 3:1 slope:

(mound height at downslope edge of bed) x (3:1 slope)

$$\begin{aligned} &= [(E) + (F) + (G)] \times (3) \\ &= (1.6 + 0.75 + 1.0) \times (3) \\ &= 10.05 \text{ ft. or } 10 \text{ ft.} \end{aligned}$$

Since the distance needed to maintain a 3:1 slope is less than the distance needed to provide sufficient basal area, (C) = 18 ft.

$$\begin{aligned} \text{Mound Width (W)} &= (J) + (A) + (C) \\ &= 8 + 10 + 18 \\ &= \underline{36 \text{ ft.}} \end{aligned}$$

Mound basal dimensions are: Length (L) = 96 ft. and Width (W) = 36 ft.

DISTRIBUTION NETWORK CALCULATIONS

Design a pressure distribution network for the mound that will ensure equal wastewater application (i.e., minimizes distribution network headloss.)

In accordance with Section 75-A.9(c)(3)(vi) of Appendix 75-A, a pressure distribution network is required for a mound system.

Step 1: Select the Lateral Length. A central manifold as depicted in **Figure 16** of the Handbook is used in this example.

$$\text{Lateral length} = \frac{74 \text{ ft.}}{2} - 2.5 \text{ ft.}$$

(minimum setback of lateral ends from the edge of the absorption bed)

$$= 34.5 \text{ ft.}$$

Step 2: Select Hole Diameter and Hole Spacing for Laterals. For this example, 1/4 in. diameter holes spaced every 5.0 feet are used, although other combinations could be used.

Step 3: Select Lateral Diameter. For 1/4 in. hole diameter, 5 ft. hole spacing, and 34.5 ft. lateral length, **Table A-1**, page 1 of 5, of Appendix A indicates approximately that a 1.25 inch diameter lateral could be used. 1.5 inch diameter pipe is selected for this example to provide for future expansion, if required.

Step 4: Calculate Lateral Discharge Rate. A 2.3 feet head is to be maintained in the lateral.

Using the orifice equation, the discharge rate for a 1/4 inch hole at 2.3 feet minimum pressure is calculated:

$$Q = CA(2gh)^{1/2}, \text{ where}$$

$C = 0.6$ (orifice coefficient for sharp-edged orifice)
 $g = \text{gravity constant} = 32.2 \text{ ft/sec}^2$
 $h = \text{head in feet}$
 $A = \text{area of orifice in feet}^2$

$$Q = 0.6 \times (3.41 \times 10^{-4} \text{ft}^2) \times (2 \times 32.2 \text{ ft/sec}^2 \times 2.3 \text{ ft})^{1/2}$$

$$Q = 2.49 \times 10^{-3} \text{ft}^3/\text{sec} \times 7.48 \text{ gal./ft}^3 \times 60 \text{ sec./min.} = 1.11 \text{ gpm/orifice}$$

(Assume this flow out each orifice. This is approximate, as changes in head between distal and supply orifices will not exceed 10% maximum, affecting Q by $\sqrt{10\%}$ or less than 3.5%)

$$\begin{aligned} \text{Number of holes per lateral} &= \frac{34.5 \text{ ft. lateral length}}{5.0 \text{ ft. hole spacing}} \\ &= 6.9 \text{ or } 7 \end{aligned}$$

$$\begin{aligned} \text{Lateral discharge rate} &= 7 \text{ holes/lateral} \times 1.11 \text{ gpm/hole} \\ &= 7.77 \text{ gpm/lateral} \end{aligned}$$

Step 5: Select Manifold Size. There are to be 4 laterals (2 on either side of a central manifold) spaced 5 feet apart. The manifold length will be 5 feet due to the width of the absorption bed (10 ft.) and the first set and last set of laterals being 2.5 feet from the edge of the absorption bed area.

For 4 laterals at 7.77 gpm/lateral, Table A-2 of Appendix A indicates that a minimum of 1.25 in. diameter manifold may be used. A 2.0 inch diameter manifold is selected for this example to provide for future system expansion, if required.

For 4 laterals at 7.77 gpm/lateral and manifold length of 5 ft., Table A-3 of Appendix A indicates that a 1.50 inch diameter manifold is required. A 2.00 inch manifold is chosen to provide for future system expansion.

Step 6: Determine Minimum Dose Volume. Dosing volume should be at least ten times the total distribution lateral pipe volume to minimize differences in discharge volumes from the supply end and distal end orifices during filling.

$$\begin{aligned} \text{Total lateral volume} &= 4 \times 34.5 \text{ ft.} \times (1.50/12)^2 \times (\pi/4) \times 7.48 \text{ gal/ft}^3 \\ &= 12.7 \text{ gal.} \\ &= 10 \times 12.7 \text{ gal.} = 127 \text{ gal/dose} \end{aligned}$$

A minimum dosing frequency of 3 doses/day is recommended for a sand or loam type soil. This should be similar to the type of soil that comprises the fill material of the mound. Therefore, the dose volume is:

$$\frac{440 \text{ gpd}}{3} = 147 \text{ gal./dose}$$

Step 7: Determine Minimum Discharge Rate.

$$\begin{aligned} \text{Minimum Discharge Rate} &= (4 \text{ laterals}) \times (7.77 \text{ gpm/lateral}) \\ &= 31.08 \text{ gpm or } \underline{31 \text{ gpm}} \end{aligned}$$

Step 8: Select Proper Pump. For this example, assume the dosing tank is located 100 ft. from the network inlet, the difference in elevation between the pump and the inverts of the distribution laterals is 7 ft., and a 2 inch diameter delivery pipe is to be used.

Friction loss in 100 ft. of 2 inch pipe at 31 gpm using the Hazen-Williams equation:

$$\begin{aligned} \text{Friction loss} &= h_f = (4.727/D^{4.87})(L)(Q/C)^{1.85} \\ &h_f = (4.727/(2.0/12)^{4.87})(100)(0.069/150)^{1.85} \end{aligned}$$

$$\text{Elevation head} = 7.0 \text{ ft.}$$

$$\text{Pressure Head to Be Maintained} = \underline{2.3 \text{ ft.}}$$

$$\text{Total Pumping Head} = \underline{11.3 \text{ ft.}}$$

Therefore, a pump capable of delivering at least 31 gpm against 11.3 ft. of head is required.

If the delivery pipe to the mound is set to drain back to the pump station due to site constraints or because it must be located above the frost line, the volume of wastewater occupying the pipe after the pump cycle has finished must be considered. In cases where the delivery pipe is of considerable length and/or diameter, a substantial amount of wastewater will drain back to the pump station following completion of the pump cycle. As such, the storage capacity of the pump station must be designed to accommodate the extra volume of wastewater flowing back to the pump station so that it is recycled with each pump cycle and the design dose to the mound is maintained.

In summary, the final network design consists of four 34.5 feet laterals with a 1.50 inch diameter (two on each side of a 2.0 inch diameter central manifold.) The inverts of the laterals are perforated with 1/4 inch holes spaced every 5 feet.

APPENDIX A

Table A-1

**RECOMMENDED PRESSURE PIPE DIAMETERS FOR VARIOUS ORIFICE DIAMETERS,
ORIFICE SPACINGS, AND MAXIMUM LATERAL LENGTHS(a),**

ORIFICE SIZE = ¼ INCH

MAXIMUM PIPE LENGTH (FEET)	PIPE DIAMETER (INCHES)	HEAD AT SUPPLY ORIFICE (FEET)(b)	TOTAL LATERAL FLOW (b) (GPM)
ORIFICE SPACING = 2 FEET			
18	1.00	2.73	11.5
26	1.25	2.71	16.0
38	1.50	2.79	23.0
48	1.75	2.75	28.7
62	2.00	2.78	36.7
90	2.50	2.77	52.8
100	3.00	2.57	57.8
ORIFICE SPACING = 3 FEET			
24	1.00	2.77	10.4
33	1.25	2.69	13.7
48	1.50	2.75	19.5
63	1.75	2.76	25.2
78	2.00	2.74	30.9
99	2.50	2.60	38.6
99	3.00	2.43	38.3
ORIFICE SPACING = 4 FEET			
28	1.00	2.74	9.2
40	1.25	2.70	12.6
56	1.50	2.72	17.2
76	1.75	2.77	23.0
96	2.00	2.77	28.7
100	2.50	2.48	29.4
100	3.00	2.38	29.2

MAXIMUM PIPE LENGTH (FEET)	PIPE DIAMETER (INCHES)	HEAD AT SUPPLY ORIFICE (FEET)(b)	TOTAL LATERAL FLOW (b) (GPM)
ORIFICE SPACING = 5 FEET			
30	1.00	2.67	8.0
45	1.25	2.67	11.4
65	1.50	2.73	16.0
85	1.75	2.73	20.6
100	2.00	2.65	24.0
100	2.50	2.43	23.6
100	3.00	2.36	23.5
ORIFICE SPACING = 6 FEET			
36	1.00	2.74	8.0
54	1.25	2.75	11.5
72	1.50	2.71	14.9
96	1.75	2.73	19.5
96	2.00	2.53	19.3
96	2.50	2.38	19.1
96	3.00	2.34	19.0
ORIFICE SPACING = 7 FEET			
35	1.00	2.62	6.9
56	1.25	2.68	10.3
84	1.50	2.78	14.9
98	1.75	2.65	17.1
98	2.00	2.49	17.0
98	2.50	2.37	16.8
98	3.00	2.33	16.8

(a) Computed for plastic pipe only. The Hazen-Williams equation was used to compute headlosses through each pipe segment (Hazen-Williams C=150). The orifice equation for shape-edged orifices (discharge coefficient = 0.6) was used to compute the discharge rates through each orifice.

(b) Head at the supply orifice and total flow are calculated assuming a minimum pressure head of 2.31 feet (1.0 psi) at the distal orifice. The maximum lateral length for each given orifice and spacing was defined as that length at which the difference between the rates of discharge from the distal end and the supply end orifice reached 10 percent of the distal end orifice discharge rate.

ORIFICE SIZE = 5/16 INCH

MAXIMUM PIPE LENGTH (FEET)	PIPE DIAMETER (INCHES)	HEAD AT SUPPLY ORIFICE (FEET)(b)	TOTAL LATERAL FLOW (b) (GPM)
ORIFICE SPACING = 2 FEET			
12	1.00	2.64	12.5
20	1.25	2.75	19.7
28	1.50	2.78	26.9
36	1.75	2.76	34.1
46	2.00	2.78	43.1
66	2.50	2.75	60.9
92	3.00	2.78	84.3
ORIFICE SPACING = 3 FEET			
15	1.00	2.61	10.7
24	1.25	2.67	16.1
36	1.50	2.77	23.3
45	1.75	2.71	28.6
60	2.00	2.79	37.7
87	2.50	2.77	53.8
99	3.00	2.58	60.3
ORIFICE SPACING = 4 FEET			
20	1.00	2.72	10.8
28	1.25	2.65	14.3
40	1.50	2.68	19.7
56	1.75	2.76	26.9
72	2.00	2.78	34.1
100	2.50	2.72	46.5
100	3.00	2.48	45.9

MAXIMUM PIPE LENGTH (FEET)	PIPE DIAMETER (INCHES)	HEAD AT SUPPLY ORIFICE (FEET)(b)	TOTAL LATERAL FLOW (b) (GPM)
ORIFICE SPACING = 5 FEET			
20	1.00	2.59	8.9
35	1.25	2.73	14.4
50	1.50	2.78	19.8
65	1.75	2.77	25.1
80	2.00	2.74	30.4
100	2.50	2.58	37.3
100	3.00	2.42	36.9
ORIFICE SPACING = 6 FEET			
24	1.00	2.65	9.0
36	1.25	2.65	12.5
54	1.50	2.73	17.9
72	1.75	2.75	23.3
90	2.00	2.74	28.7
96	2.50	2.48	30.0
96	3.00	2.38	29.8
ORIFICE SPACING = 7 FEET			
28	1.00	2.71	9.0
42	1.25	2.70	12.5
56	1.50	2.66	16.1
77	1.75	2.71	21.5
98	2.00	2.72	26.8
98	2.50	2.45	26.4
98	3.00	2.37	26.3

(a) Computed for plastic pipe only. The Hazen-Williams equation was used to compute headlosses through each pipe segment (Hazen-Williams C=150). The orifice equation for shape-edged orifices (discharge coefficient = 0.6) was used to compute the discharge rates through each orifice.

(b) Head at the supply orifice and total flow are calculated assuming a minimum pressure head of 2.31 feet (1.0 psi) at the distal orifice. The maximum lateral length for each given orifice and spacing was defined as that length at which the difference between the rates of discharge from the distal end and the supply end orifice reached 10 percent of the distal end orifice discharge rate.

ORIFICE SIZE = 3/8 INCH

MAXIMUM PIPE LENGTH (FEET)	PIPE DIAMETER (INCHES)	HEAD AT SUPPLY ORIFICE (FEET)(b)	TOTAL LATERAL FLOW (b) (GPM)
ORIFICE SPACING = 2 FEET			
10	1.00	2.71	15.5
16	1.25	2.79	23.3
22	1.50	2.78	31.0
28	1.75	2.75	38.7
36	2.00	2.78	49.1
52	2.50	2.76	69.6
72	3.00	2.77	95.5
ORIFICE SPACING = 3 FEET			
12	1.00	2.64	12.9
18	1.25	2.64	18.0
27	1.50	2.72	25.8
36	1.75	2.74	33.6
45	2.00	2.73	41.3
69	2.50	2.79	62.0
93	3.00	2.77	82.6
ORIFICE SPACING = 4 FEET			
16	1.00	2.76	13.0
24	1.25	2.75	18.1
32	1.50	2.71	23.2
44	1.75	2.76	31.0
56	2.00	2.77	38.8
80	2.50	2.74	54.1
100	3.00	2.64	66.6

MAXIMUM PIPE LENGTH (FEET)	PIPE DIAMETER (INCHES)	HEAD AT SUPPLY ORIFICE (FEET)(b)	TOTAL LATERAL FLOW (b) (GPM)
ORIFICE SPACING = 5 FEET			
15	1.00	2.58	10.3
25	1.25	2.65	15.5
35	1.50	2.66	20.6
50	1.75	2.75	28.4
65	2.00	2.78	36.2
95	2.50	2.78	51.7
100	3.00	2.53	53.5
ORIFICE SPACING = 6 FEET			
18	1.00	2.63	10.3
30	1.25	2.72	15.5
42	1.50	2.73	20.7
54	1.75	2.70	25.8
72	2.00	2.77	33.6
96	2.50	2.65	43.6
96	3.00	2.45	43.1
ORIFICE SPACING = 7 FEET			
21	1.00	2.69	10.4
28	1.25	2.58	12.8
42	1.50	2.63	18.0
63	1.75	2.77	25.9
77	2.00	2.73	31.0
98	2.50	2.59	38.4
98	3.00	2.42	38.0

(a) Computed for plastic pipe only. The Hazen-Williams equation was used to compute headlosses through each pipe segment (Hazen-Williams C=150). The orifice equation for shape-edged orifices (discharge coefficient = 0.6) was used to compute the discharge rates through each orifice.

(b) Head at the supply orifice and total flow are calculated assuming a minimum pressure head of 2.31 feet (1.0 psi) at the distal orifice. The maximum lateral length for each given orifice and spacing was defined as that length at which the difference between the rates of discharge from the distal end and the supply end orifice reached 10 percent of the distal end orifice discharge rate.

ORIFICE SIZE = 7/16 INCH

MAXIMUM PIPE LENGTH (FEET)	PIPE DIAMETER (INCHES)	HEAD AT SUPPLY ORIFICE (FEET)(b)	TOTAL LATERAL FLOW (b) (GPM)
ORIFICE SPACING = 2 FEET			
8	1.00	2.71	17.6
12	1.25	2.70	24.6
16	1.50	2.66	31.5
22	1.75	2.71	42.1
28	2.00	2.72	52.6
42	2.50	2.74	77.2
58	3.00	2.76	105.3
ORIFICE SPACING = 3 FEET			
9	1.00	2.60	14.0
15	1.25	2.67	21.0
21	1.50	2.68	28.0
30	1.75	2.77	38.7
36	2.00	2.71	45.6
54	2.50	2.73	66.7
75	3.00	2.75	91.3
ORIFICE SPACING = 4 FEET			
12	1.00	2.69	14.1
16	1.25	2.58	17.5
24	1.50	2.64	24.5
36	1.75	2.78	35.2
44	2.00	2.73	42.1
64	2.50	2.72	59.6
92	3.00	2.78	84.4

MAXIMUM PIPE LENGTH (FEET)	PIPE DIAMETER (INCHES)	HEAD AT SUPPLY ORIFICE (FEET)(b)	TOTAL LATERAL FLOW (b) (GPM)
ORIFICE SPACING = 5 FEET			
15	1.00	2.79	14.2
20	1.25	2.65	17.5
30	1.50	2.72	24.6
40	1.75	2.73	31.6
50	2.00	2.72	38.6
75	2.50	2.74	56.2
100	3.00	2.71	73.6
ORIFICE SPACING = 6 FEET			
12	1.00	2.52	10.5
24	1.25	2.72	17.6
30	1.50	2.61	21.0
42	1.75	2.66	28.0
54	2.00	2.68	35.0
84	2.50	2.73	52.7
96	3.00	2.56	59.1
ORIFICE SPACING = 7 FEET			
14	1.00	2.56	10.5
28	1.25	2.79	17.7
35	1.50	2.66	21.0
49	1.75	2.72	28.1
63	2.00	2.74	35.2
91	2.50	2.71	49.1
98	3.00	2.51	52.0

(a) Computed for plastic pipe only. The Hazen-Williams equation was used to compute headlosses through each pipe segment (Hazen-Williams C=150). The orifice equation for shape-edged orifices (discharge coefficient = 0.6) was used to compute the discharge rates through each orifice.

(b) Head at the supply orifice and total flow are calculated assuming a minimum pressure head of 2.31 feet (1.0 psi) at the distal orifice. The maximum lateral length for each given orifice and spacing was defined as that length at which the difference between the rates of discharge from the distal end and the supply end orifice reached 10 percent of the distal end orifice discharge rate.

ORIFICE SIZE = ½ INCH

MAXIMUM PIPE LENGTH (FEET)	PIPE DIAMETER (INCHES)	HEAD AT SUPPLY ORIFICE (FEET)(b)	TOTAL LATERAL FLOW (b) (GPM)
ORIFICE SPACING = 2 FEET			
6	1.00	2.62	18.3
10	1.25	2.71	27.6
14	1.50	2.71	36.7
18	1.75	2.69	45.8
24	2.00	2.75	59.7
36	2.50	2.77	87.3
48	3.00	2.74	114.6
ORIFICE SPACING = 3 FEET			
9	1.00	2.78	18.5
12	1.25	2.64	22.9
18	1.50	2.71	32.1
24	1.75	2.72	41.3
30	2.00	2.71	50.4
45	2.50	2.73	73.3
63	3.00	2.76	100.9
ORIFICE SPACING = 4 FEET			
8	1.00	2.54	13.7
16	1.25	2.76	23.1
20	1.50	2.64	27.4
28	1.75	2.70	36.7
36	2.00	2.71	45.8
56	2.50	2.77	68.9
76	3.00	2.76	91.8

MAXIMUM PIPE LENGTH (FEET)	PIPE DIAMETER (INCHES)	HEAD AT SUPPLY ORIFICE (FEET)(b)	TOTAL LATERAL FLOW (b) (GPM)
ORIFICE SPACING = 5 FEET			
10	1.00	2.60	13.8
15	1.25	2.58	18.3
25	1.50	2.73	27.6
30	1.75	2.63	32.0
40	2.00	2.67	41.2
65	2.50	2.78	64.4
85	3.00	2.72	82.4
ORIFICE SPACING = 6 FEET			
12	1.00	2.66	13.8
18	1.25	2.63	18.3
24	1.50	2.59	22.8
36	1.75	2.69	32.1
48	2.00	2.75	41.4
72	2.50	2.76	59.7
96	3.00	2.73	77.9
ORIFICE SPACING = 7 FEET			
14	1.00	2.72	13.9
21	1.25	2.69	18.4
28	1.50	2.64	22.9
42	1.75	2.76	32.2
49	2.00	2.67	36.6
77	2.50	2.73	55.0
98	3.00	2.65	68.4

(a) Computed for plastic pipe only. The Hazen-Williams equation was used to compute headlosses through each pipe segment (Hazen-Williams C=150). The orifice equation for shape-edged orifices (discharge coefficient = 0.6) was used to compute the discharge rates through each orifice.

(b) Head at the supply orifice and total flow are calculated assuming a minimum pressure head of 2.31 feet (1.0 psi) at the distal orifice. The maximum lateral length for each given orifice and spacing was defined as that length at which the difference between the rates of discharge from the distal end and the supply end orifice reached 10 percent of the distal end orifice discharge rate.

APPENDIX A, TABLE A-2, RECOMMENDED MANIFOLD SIZES FOR PRESSURE DISTRIBUTION NETWORKS
6 FEET CENTER-TO-CENTER SPACING BETWEEN TRENCHES^{a,b}

pipe dia. (in.)	max. length (feet)	end head (feet)	# of laterals	pipe dia. (in.)	max. length (feet)	end head (feet)	# of laterals	pipe dia. (in.)	max. length (feet)	end head (feet)	# of laterals	pipe dia. (in.)	max. length (feet)	end head (feet)	# of laterals
flow/lateral = 5 gpm															
1.25	12	2.94	3	1.50	6	2.97	2	1.75	6	3.03	2	2.50	6	2.89	2
1.50	18	2.96	4	1.75	6	2.88	2	2.00	6	2.92	2	3.00	12	2.98	3
1.75	18	2.87	4	2.00	12	3.00	3	2.50	12	2.99	3	4.00	18	2.92	4
2.00	18	2.83	4	2.50	18	2.98	4	3.00	18	3.01	4	5.00	18	2.84	4
2.50	18	2.81	4	3.00	18	2.87	4	4.00	18	2.85	4	6.00	18	2.81	4
3.00	18	2.80	4	4.00	18	2.81	4	5.00	18	2.81	4	flow/lateral = 60 gpm			
4.00	18	2.79	4	5.00	18	2.80	4	6.00	18	2.80	4	2.50	6	2.91	2
5.00	18	2.79	4	flow/lateral = 25 gpm								3.00	12	3.02	3
6.00	18	2.79	4	flow/lateral = 40 gpm								4.00	18	2.94	4
flow/lateral = 10 gpm															
1.25	6	2.91	2	1.50	6	3.06	2	2.00	6	2.95	2	flow/lateral = 65 gpm			
1.50	12	3.02	3	1.75	6	2.92	2	2.50	12	3.04	3	2.50	6	2.93	2
1.75	12	2.90	3	2.00	6	2.86	2	3.00	12	2.90	3	3.00	12	3.05	3
2.00	18	2.94	4	2.50	12	2.90	3	4.00	18	2.86	4	4.00	18	2.97	4
2.50	18	2.84	4	3.00	18	2.91	4	5.00	18	2.82	4	5.00	18	2.85	4
3.00	18	2.81	4	4.00	18	2.82	4	6.00	18	2.80	4	6.00	18	2.82	4
4.00	18	2.80	4	5.00	18	2.80	4	flow/lateral = 45 gpm							
5.00	18	2.79	4	6.00	18	2.80	4	2.00	6	2.99	2	flow/lateral = 70 gpm			
6.00	18	2.79	4	flow/lateral = 30 gpm								2.50	6	2.86	2
flow/lateral = 15 gpm															
1.25	6	3.04	2	1.75	6	2.97	2	2.00	6	2.88	2	2.50	6	2.95	2
1.50	6	2.89	2	2.00	6	2.88	2	2.50	12	2.94	3	3.00	6	2.86	2
1.75	12	3.02	3	3.00	18	2.96	4	4.00	18	2.96	4	4.00	18	2.99	4
2.00	12	2.91	3	4.00	18	2.83	4	5.00	18	2.81	4	5.00	18	2.86	4
2.50	18	2.90	4	5.00	18	2.81	4	6.00	18	2.80	4	6.00	18	2.82	4
3.00	18	2.84	4	flow/lateral = 50 gpm								flow/lateral = 70 gpm			
4.00	18	2.80	4	1.75	6	2.97	2	2.00	6	3.03	2	2.50	6	2.95	2
5.00	18	2.79	4	2.00	6	2.88	2	2.50	6	2.87	2	3.00	6	2.86	2
6.00	18	2.79	4	3.00	12	2.94	3	4.00	18	2.95	3	4.00	18	2.99	4
flow/lateral = 50 gpm															
1.25	6	3.04	2	2.00	6	2.80	4	2.50	6	2.87	2	3.00	6	2.86	2
1.50	6	2.89	2	2.50	12	2.80	4	3.00	12	2.95	3	4.00	18	2.99	4
1.75	12	3.02	3	4.00	18	2.80	4	5.00	18	2.83	4	5.00	18	2.86	4
2.00	12	2.91	3	5.00	18	2.81	4	6.00	18	2.80	4	6.00	18	2.82	4
2.50	18	2.90	4	flow/lateral = 30 gpm								flow/lateral = 70 gpm			
3.00	18	2.84	4	1.75	6	2.97	2	2.00	6	3.03	2	2.50	6	2.95	2
4.00	18	2.80	4	2.00	6	2.88	2	2.50	6	2.87	2	3.00	6	2.86	2
5.00	18	2.79	4	3.00	12	2.94	3	4.00	18	2.95	3	4.00	18	2.99	4
6.00	18	2.79	4	4.00	18	2.80	4	5.00	18	2.83	4	5.00	18	2.86	4
flow/lateral = 30 gpm															
1.25	6	3.04	2	5.00	18	2.81	4	6.00	18	2.83	4	6.00	18	2.82	4
1.50	6	2.89	2	flow/lateral = 50 gpm								flow/lateral = 70 gpm			
1.75	12	3.02	3	1.75	6	2.97	2	2.00	6	3.03	2	2.50	6	2.95	2
2.00	12	2.91	3	2.00	6	2.88	2	2.50	6	2.87	2	3.00	6	2.86	2
2.50	18	2.90	4	3.00	12	2.94	3	4.00	18	2.95	3	4.00	18	2.99	4
3.00	18	2.84	4	4.00	18	2.80	4	5.00	18	2.83	4	5.00	18	2.86	4
4.00	18	2.80	4	5.00	18	2.81	4	6.00	18	2.80	4	6.00	18	2.82	4
5.00	18	2.79	4	flow/lateral = 30 gpm								flow/lateral = 70 gpm			
6.00	18	2.79	4	1.75	6	2.97	2	2.00	6	3.03	2	2.50	6	2.95	2
flow/lateral = 30 gpm															
1.25	6	3.04	2	2.00	6	2.88	2	2.50	6	2.87	2	3.00	6	2.86	2
1.50	6	2.89	2	3.00	12	2.94	3	4.00	18	2.95	3	4.00	18	2.99	4
1.75	12	3.02	3	4.00	18	2.80	4	5.00	18	2.83	4	5.00	18	2.86	4
2.00	12	2.91	3	5.00	18	2.81	4	6.00	18	2.80	4	6.00	18	2.82	4
2.50	18	2.90	4	flow/lateral = 50 gpm								flow/lateral = 70 gpm			
3.00	18	2.84	4	1.75	6	2.97	2	2.00	6	3.03	2	2.50	6	2.95	2
4.00	18	2.80	4	2.00	6	2.88	2	2.50	6	2.87	2	3.00	6	2.86	2
5.00	18	2.79	4	3.00	12	2.94	3	4.00	18	2.95	3	4.00	18	2.99	4
6.00	18	2.79	4	4.00	18	2.80	4	5.00	18	2.83	4	5.00	18	2.86	4
flow/lateral = 30 gpm															
1.25	6	3.04	2	5.00	18	2.81	4	6.00	18	2.83	4	6.00	18	2.82	4

a - Computed for plastic pipe only. The Hazen-Williams equation was used to compute headlosses through each manifold pipe segment (Hazen-Williams C = 150). Minimum head at the manifold distal end is 2.79 ft. (i.e., to ensure 2.31 ft./1.0 psi of pressure head at the most distal orifice in the distribution lateral(s)). Minimum size of a manifold is limited by the difference in heads at the distal end and the supply end of the manifold not exceeding 10% of the head at the distal end. b - The flow per lateral and the number of laterals listed in this table are for end distribution networks. Double the flow per lateral and the number of laterals listed if central distribution manifolds are to be used.

**APPENDIX A, Table A-3, RECOMMENDED MANIFOLD SIZES FOR PRESSURE DISTRIBUTION NETWORKS
5 FEET CENTER-TO-CENTER SPACING BETWEEN LATERALS IN ABSORPTION BEDS^{a, b}**

pipe dia. (in.)	max. length (feet)	supply end head (feet)	# of laterals	pipe dia. (in.)	max. length (feet)	supply end head (feet)	# of laterals	pipe dia. (in.)	max. length (feet)	supply end head (feet)	# of laterals	pipe dia. (in.)	max. length (feet)	supply end head (feet)	# of laterals
flow/lateral = 5 gpm															
1.25	10	2.91	3	1.50	5	2.94	2	1.75	5	2.99	2	2.00	5	3.03	2
1.50	15	2.93	4	1.75	5	2.86	2	2.00	5	2.90	2	2.50	5	2.87	2
1.75	15	2.86	4	2.00	10	2.96	3	2.50	10	2.96	3	3.00	10	2.95	3
2.00	15	2.83	4	2.50	15	2.95	4	3.00	15	2.97	4	4.00	15	2.90	4
2.50	15	2.80	4	3.00	15	2.86	4	4.00	15	2.84	4	5.00	15	2.83	4
3.00	15	2.80	4	4.00	15	2.81	4	5.00	15	2.81	4	6.00	15	2.81	4
4.00	15	2.79	4	5.00	15	2.80	4	6.00	15	2.80	4				
5.00	15	2.79	4	6.00	15	2.79	4								
6.00	15	2.79	4												
flow/lateral = 10 gpm															
1.25	5	2.89	2	1.50	5	3.01	2	1.75	5	3.04	2	2.50	5	2.89	2
1.50	10	2.98	3	1.75	5	2.90	2	2.00	5	2.92	2	3.00	10	2.98	3
1.75	15	3.03	4	2.00	10	3.05	3	2.50	10	3.00	3	4.00	15	2.92	4
2.00	15	2.92	4	2.50	15	3.03	3	3.00	15	2.85	4	5.00	15	2.83	4
2.50	15	2.83	4	3.00	15	2.89	4	4.00	15	2.81	4	6.00	15	2.81	4
3.00	15	2.81	4	4.00	15	2.82	4	5.00	15	2.80	4				
4.00	15	2.80	4	5.00	15	2.80	4	6.00	15	2.80	4				
5.00	15	2.79	4	6.00	15	2.79	4								
6.00	15	2.79	4												
flow/lateral = 15 gpm															
1.25	5	3.00	2	1.75	5	2.94	2	2.00	5	2.96	2	2.50	5	2.90	2
1.50	5	2.88	2	2.00	5	2.87	2	2.50	10	3.05	3	3.00	10	3.01	3
1.75	10	2.98	3	2.50	10	2.92	3	3.00	10	2.90	3	4.00	15	2.94	4
2.00	15	3.06	4	3.00	15	2.93	4	4.00	15	2.86	4	5.00	15	2.84	4
2.50	15	2.88	4	4.00	15	2.83	4	5.00	15	2.82	4	6.00	15	2.81	4
3.00	15	2.83	4	5.00	15	2.80	4								
4.00	15	2.80	4	6.00	15	2.80	4								
5.00	15	2.79	4												
6.00	15	2.79	4												
flow/lateral = 20 gpm															
1.25	5	2.94	2	1.50	5	2.94	2	1.75	5	2.99	2	2.00	5	3.03	2
1.50	10	2.93	4	1.75	5	2.86	2	2.00	5	2.90	2	2.50	5	2.87	2
1.75	15	2.86	4	2.00	10	2.96	3	2.50	10	2.96	3	3.00	10	2.95	3
2.00	15	2.83	4	2.50	15	2.95	4	3.00	15	2.97	4	4.00	15	2.90	4
2.50	15	2.80	4	3.00	15	2.86	4	4.00	15	2.84	4	5.00	15	2.83	4
3.00	15	2.80	4	4.00	15	2.81	4	5.00	15	2.81	4	6.00	15	2.81	4
4.00	15	2.79	4	5.00	15	2.80	4	6.00	15	2.80	4				
5.00	15	2.79	4	6.00	15	2.79	4								
6.00	15	2.79	4												
flow/lateral = 25 gpm															
1.25	5	2.89	2	1.50	5	3.01	2	1.75	5	3.04	2	2.50	5	2.89	2
1.50	10	2.98	3	1.75	5	2.90	2	2.00	5	2.92	2	3.00	10	2.98	3
1.75	15	3.03	4	2.00	10	3.05	3	2.50	10	3.00	3	4.00	15	2.92	4
2.00	15	2.92	4	2.50	15	3.03	3	3.00	15	2.85	4	5.00	15	2.83	4
2.50	15	2.83	4	3.00	15	2.89	4	4.00	15	2.81	4	6.00	15	2.81	4
3.00	15	2.81	4	4.00	15	2.82	4	5.00	15	2.80	4				
4.00	15	2.80	4	5.00	15	2.80	4	6.00	15	2.80	4				
5.00	15	2.79	4	6.00	15	2.79	4								
6.00	15	2.79	4												
flow/lateral = 30 gpm															
1.25	5	3.00	2	1.75	5	2.94	2	2.00	5	2.96	2	2.50	5	2.90	2
1.50	5	2.88	2	2.00	5	2.87	2	2.50	10	3.05	3	3.00	10	3.01	3
1.75	10	2.98	3	2.50	10	2.92	3	3.00	10	2.90	3	4.00	15	2.94	4
2.00	15	3.06	4	3.00	15	2.93	4	4.00	15	2.86	4	5.00	15	2.84	4
2.50	15	2.88	4	4.00	15	2.83	4	5.00	15	2.82	4	6.00	15	2.81	4
3.00	15	2.83	4	5.00	15	2.80	4								
4.00	15	2.80	4	6.00	15	2.80	4								
5.00	15	2.79	4												
6.00	15	2.79	4												
flow/lateral = 40 gpm															
1.25	5	3.04	2	1.75	5	3.04	2	2.00	5	3.04	2	2.50	5	2.89	2
1.50	10	2.98	3	1.75	5	2.92	2	2.00	5	2.92	2	3.00	10	2.98	3
1.75	15	3.03	4	2.00	10	3.03	3	2.50	10	3.00	3	4.00	15	2.92	4
2.00	15	2.85	4	2.50	15	2.85	4	3.00	15	2.85	4	5.00	15	2.83	4
2.50	15	2.81	4	3.00	15	2.81	4	4.00	15	2.81	4	6.00	15	2.81	4
3.00	15	2.80	4	4.00	15	2.80	4	5.00	15	2.80	4				
4.00	15	2.80	4	5.00	15	2.80	4	6.00	15	2.80	4				
5.00	15	2.79	4	6.00	15	2.79	4								
6.00	15	2.79	4												
flow/lateral = 45 gpm															
1.25	5	2.96	2	1.75	5	2.96	2	2.00	5	2.96	2	2.50	5	2.90	2
1.50	10	3.05	3	1.75	5	3.05	3	2.00	5	3.05	3	3.00	10	3.01	3
1.75	15	2.90	3	2.00	10	2.90	3	2.50	10	2.90	3	4.00	15	2.94	4
2.00	15	2.86	4	2.50	15	2.86	4	3.00	15	2.86	4	5.00	15	2.84	4
2.50	15	2.82	4	3.00	15	2.82	4	4.00	15	2.82	4	6.00	15	2.81	4
3.00	15	2.80	4	4.00	15	2.80	4	5.00	15	2.80	4				
4.00	15	2.80	4	5.00	15	2.80	4	6.00	15	2.80	4				
5.00	15	2.79	4	6.00	15	2.79	4								
6.00	15	2.79	4												
flow/lateral = 50 gpm															
1.25	5	2.99	2	1.75	5	2.99	2	2.00	5	2.99	2	2.50	5	2.92	2
1.50	10	2.86	2	1.75	5	2.86	2	2.00	5	2.86	2	3.00	10	3.04	3
1.75	15	2.92	3	2.00	10	2.92	3	2.50	10	2.92	3	4.00	15	2.96	4
2.00	15	2.88	4	2.50	15	2.88	4	3.00	15	2.88	4	5.00	15	2.85	4
2.50	15	2.82	4	3.00	15	2.82	4	4.00	15	2.82	4	6.00	15	2.82	4
3.00	15	2.80	4	4.00	15	2.80	4	5.00	15	2.80	4				
4.00	15	2.79	4	5.00	15	2.79	4	6.00	15	2.79	4				
5.00	15	2.79	4	6.00	15	2.79	4								
6.00	15	2.79	4												

a – Computed for plastic pipe only. The Hazen-Williams equation was used to compute headlosses through each manifold pipe segment (Hazen-Williams C = 150). Minimum head at the manifold distal end is 2.79 ft. (i.e., to ensure 2.31 ft./1.0 psi of pressure head at the most distal orifice in the distribution lateral(s)). Minimum size of a manifold is limited by the difference in heads at the distal end and the supply end of the manifold not exceeding 10% of the head at the distal end.

**APPENDIX A
TABLE A-4**

**DISCHARGE RATES FOR VARIOUS SIZED HOLES
AT VARIOUS PRESSURES (GPM)
BASED ON ORIFICE EQUATION**, C = 0.6**

PRESSURE		HOLE DIAMETER (IN.)				
(feet of head)	(PSI)	1/4	5/16	3/8	7/16	1/2
2.3	1.00*	1.12	1.75	2.51	3.42	4.47
3	1.30	1.28	2.00	2.87	3.90	5.10
4	1.73	1.48	2.31	3.31	4.51	5.89
5	2.17	1.65	2.58	3.70	5.04	6.59
6	2.60	1.81	2.83	4.06	5.52	7.22

* A minimum 2.3 feet head is to be maintained in the distribution lateral (i.e. equals 1.0 psi).

** Orifice Equation:

$$Q = CA(2gh)^{1/2} \text{ where}$$

Q = flow in cubic feet per second (cfs)

C = 0.6 (orifice coefficient for sharp-edged orifice)

g = gravity constant = 32.2 ft/sec²

h = head in feet

A = area of orifice in feet²

Note: Multiply Q (cfs) by 7.48 gallons/ft³ and 60 seconds/minute to get gallons per minute (gpm)

This page intentionally left Blank

Appendix B

NYSDOH Fact Sheets

Includes:

“Need for Licensed Design Professionals - Residential OWTs” B-1

Individual Water Supply Fact Sheets:

#1: Use of Additional Measures in Water Well Siting and Construction B-3

#2: Water Storage..... B-4

#3: Recommended Residential Water Quality Testing..... B-6

#4: Decommissioning Abandoned Wells B-8

#5: Susceptible Water Sources B-10

“Concerns About Surface Water as a Drinking Water Source” B-12

This page intentionally left Blank

NEW YORK STATE DEPARTMENT OF HEALTH

Bureau of Water Supply Protection

Room 1110, Corning Tower, Empire State Plaza, Albany, New York 12237

Residential Onsite Wastewater Treatment Systems FACT SHEET #1

Need for Licensed Design Professionals - Residential Onsite Wastewater Treatment Systems

Purpose: Provide guidance to regulatory officials and interested parties regarding the need for a licensed professional engineer or architect to design residential (individual) onsite wastewater treatment systems (OWTSs). The State Education Department has reviewed this document with the State Department of Health and offers the following as guidance in applying the requirements of the New York State Education Law relating to the design of OWTSs.

Licensed Design Professional: The Department of Health and the State Education Department recognize that, generally, OWTS design activities come within the definition of the practice of professional engineering or architecture under [Article 145](#) or [Article 147](#) of Title VIII of the New York State Education Law and that OWTS designs must be prepared by a design professional appropriately licensed by and currently registered with the State Education Department or otherwise authorized under such law. In addition, [10NYCRR Part 75](#) (Part 75) defines a design professional as "...a person licensed to practice engineering or architecture in New York State by the State Education Department in accordance with Article 145 or Article 147 of Title VIII of the New York State Education Law, respectively, and who is currently registered with the New York State Education Department". Part 75 also states that "Plans for the design of individual onsite wastewater treatment systems shall be prepared directly by or under the supervision of a design professional." Please be advised that licensees providing OWTS design services must be qualified to provide those services based upon education, training, and experience. Any licensee providing services that they are not qualified to provide may be subject to professional misconduct charges.

OWTS design activities include the evaluation of surface and subsurface site conditions at a defined parcel of land, which may include the investigation of soil characteristics, the performance of soil percolation tests, the determination of subsurface boundary condition and depths, the measurement and recording of existing surface features both natural and manmade, and the subsequent application of these data and the data related to proposed wastewater generation to design an OWTS. These activities generally fall within the scope of practice of professional engineering or architecture.

New Residential Construction: The design of all new residential OWTSs (including conventional systems) shall be performed by an appropriately licensed design professional, as defined above. The design may also be issued/approved by county health departments where such issuance/approval is performed and authorized by an appropriately licensed design professional on staff. Private practice engineers and architects, and engineering and architectural firms with appropriately licensed design professionals may also provide such services.

Additions or Alterations: An OWTS evaluation shall be performed and submitted by a licensed design professional for home alterations resulting in an increase in the number of bedrooms, for complete home replacements (including those resulting in the same number of bedrooms) and for alterations resulting in significant increases in wastewater generation. The evaluation must document if the existing OWTS complies with applicable State and local design standards, if the OWTS and its components are in satisfactory condition and functioning properly and if the existing OWTS can properly treat the proposed increase in wastewater generation. If the existing OWTS does not comply with regulatory design standards or needs significant modification, the licensed design professional shall prepare plans and oversee the installation of the alterations to the OWTS. This may include incorporating appropriate mitigative measures and/or designs as such ordinarily come within the scope of practice of professional engineering.

Repairs and Replacements: The repair or replacement of OWTS components "in kind" or "like-for-like" may not require the involvement of a licensed design professional. However, repair or replacement of any type of absorption field that involves relocating or extending an absorption area to a location not previously approved for such, does require a licensed design professional. A licensed design professional is required when repair or replacement involves installation of a new subsurface treatment system at the same location or the use of an alternative system (i.e., raised system, mounds, or sand filter) or innovative system design or technology.

Note: In all cases: 1) local government, watershed protection agencies or other jurisdictional agency rules and regulations may also apply; 2) All OWTS design plans must be prepared by a design professional licensed to practice in New York State; 3) When no regulatory agency is responsible for inspection of a constructed OWTS, it is recommended that a written certificate of compliance be submitted by a New York State licensed professional engineer or architect prior to occupancy.

For questions concerning this Fact Sheet:

Residential Sanitation Section
Bureau of Water Supply Protection
New York State Department of Health
(518) 402-7650 or FAX (518) 402-7659
E-mail: bpwsp@health.state.ny.us



INDIVIDUAL WATER SUPPLY WELLS - FACT SHEET #1 USE OF "ADDITIONAL MEASURES" IN WATER WELL SITING AND CONSTRUCTION

The best way to assure drinking water wells will produce safe water is to maximize separation distances between wells and potential contaminant sources and to install wells in a way that minimizes potential of contamination. Compliance with the well construction standards in New York State regulations (Appendix 5-B of 10 NYCRR Part 5) will help assure that new and replacement wells provide reliable potable drinking water. Water well construction should routinely meet these standards; when they can not be met, additional measures to assure water potability may be necessary. Additional measures can be used as supplemental controls to reduce the risk of contaminants entering a well and provide for a safe and sanitary water supply. These measures are most likely to find use when either separation distances can not reasonably be met or where shallow wells (e.g. whenever aquifer water enters the water well at less than 50 feet below grade) must be used.

"Additional Measures"

- **Using deeper well casing, enhanced grouting, or selective screening** to prevent shallow contaminants from entering the well, or to ensure only desirable water enters the well. Examples of enhanced grouting include grouting deeper than required or selectively grouting sections of the well's borehole. These methods should be performed by a registered well driller only. A list of registered well drillers can be found at <http://www.dec.ny.gov/cfm/xtapps/WaterWell/index.cfm>
- **Redirection of surface runoff, near-surface groundwater, or both** (e.g. drainage ditches, berms, swales, curtain drains), to minimize the potential for contaminant transport toward a well.
- **Removal or relocation of potential sources of contamination** from areas that could impact a well. Some examples might be the replacement of a failing Onsite Wastewater Treatment System (OWTS), relocation of an existing OWTS farther away or down-gradient from the well, relocation of manure storage areas, and others.
- **Hydrogeologic evaluation** to demonstrate that a well is adequately protected against contamination (e.g. by a thick clay layer over the aquifer). Such investigation may involve evaluation of boring logs, aquifer characteristics (e.g., flow direction), analytical data of soil and water samples, and other local geological and hydrogeological information.
- **Treatment and/or disinfection** (this is the last resort for private unregulated water systems) may be used to ensure that contaminated or potentially contaminated water remains potable. Contact your Local Health Department regarding treatment and monitoring options.

If "additional measures" are necessary because the well does not meet requirements of the regulations, a waiver from the Local Health Department (LHD) may be required. Please contact your Local Health Department to determine the need and extent of any waiver requirements.

Appendix 5-B can be found at

<http://www.health.state.ny.us/environmental/water/drinking/part5/appendix5b.htm>

For questions concerning this Fact Sheet or a copy of Appendix 5-B:

Contact your Local Health Department	or	Residential Sanitation Section Bureau of Water Supply Protection New York State Department of Health (518) 402-7650 or FAX (518) 402-7659 E-mail: bpwsp@health.state.ny.us
--------------------------------------	----	--

This page intentionally left Blank



INDIVIDUAL WATER SUPPLY WELLS - FACT SHEET #2

WATER STORAGE

A drinking water well capable of providing a sufficient quantity of water is indispensable for homes that are not served by a public water system. Low yielding wells may be able to provide sufficient quantity for daily use, yet be unable to meet peak demand. Supplemental water storage can allow low yield wells to meet peak water use demand.

Well Yield, Water Demand, and Storage

Well yield is a sustainable rate of water flow, usually expressed in gallons per minute (gpm), that a well can draw continuously over an extended period. The Department's well construction standards, Appendix 5-B of 10 NYCRR Subpart 5-1, require that all new, replacement, and redeveloped drinking water wells be tested for yield.

Daily water usage can be estimated for typical households based on the number of occupants or bedrooms. A household with moderate water use will typically need 110 gallons of water per day per bedroom. This number, however, does not take into account extra water needed for homes with high occupancy, lawn irrigation, spa tubs, and other activities and plumbing fixtures that have a high water demand. Higher water use activities and fixtures are not recommended for homes served by low yield wells.

Peak residential water demand typically occurs in the morning and evening when more than one water use is occurring. Peak demand can vary greatly based on the number of simultaneous water uses, the flow rates of individual water fixtures, and the length of time fixtures operate. 5 gpm (two fixtures running simultaneously at 2.5 gpm) is a good estimate of peak demand, for the typical household. Water wells that reliably yield 5 gpm should be able to meet peak and daily needs for most residences.

Wells yielding less than 5 gpm, however, are sometimes the only water source available. These lower yield wells can often meet the total daily water demand, but may not be able to satisfy a household's peak demand. Incorporating supplemental water storage into a household water system can allow low yielding wells to meet both daily household and peak demand. This can prevent low pressure and inadequate water flow when multiple fixtures are in use, reducing the need to schedule showers, laundry, and other water uses for inconvenient times.

Steps in Determining Supplemental Storage Needs

1. Determine the yield of the well. An accurate yield test is essential for evaluating storage. Water well drillers are required to follow Appendix 5-B when determining well yield.
2. If the well yield is less than 5 gpm the table on the reverse can be used to select the amount of supplemental storage needed for households with typical moderate water use.
3. Sufficient storage can be provided by a storage tank. A storage tank may be reduced in size, however, or may not be necessary if sufficient storage is available within the well itself. The typical 6-inch diameter well will hold approximately 1.5 gallons of water per foot of casing. The height of the water above the pump when it is not operating, multiplied by the gallons of water per foot of casing approximates the amount of available storage within the well casing. Shallow wells and wells with slow recovery may not contain reliable storage and caution is advised when considering their potential for storage capacity.

4. Water well professionals should be consulted for advice on selecting storage for households where water use is higher than at typical households, and when storage in the well casing is being considered. A list of registered water well drillers can be found at <http://www.dec.ny.gov/cfm/xtapps/WaterWell/index.cfm>

Storage Recommendations

A well for a private residence should, if possible, be constructed to produce a minimum long-term sustainable yield of 5 gpm or more. Where this can not be achieved, the following table can be used to help select water storage that will allow low yield wells to meet peak household water demand. This storage can be provided by a tank, storage in the well, or a combination of both.

Recommended Minimum Storage (Gallons)				
	Number of Bedrooms			
Well Yield (GPM)	2	3	4	5
≥ 5	None			
3 to 5	100	150	200	250
1 to 3	150	200	250	300
0.5 to 1	200	250		
< 0.5	Not recommended for use			

Diagram of a typical water tank, providing supplemental storage for a well water system.

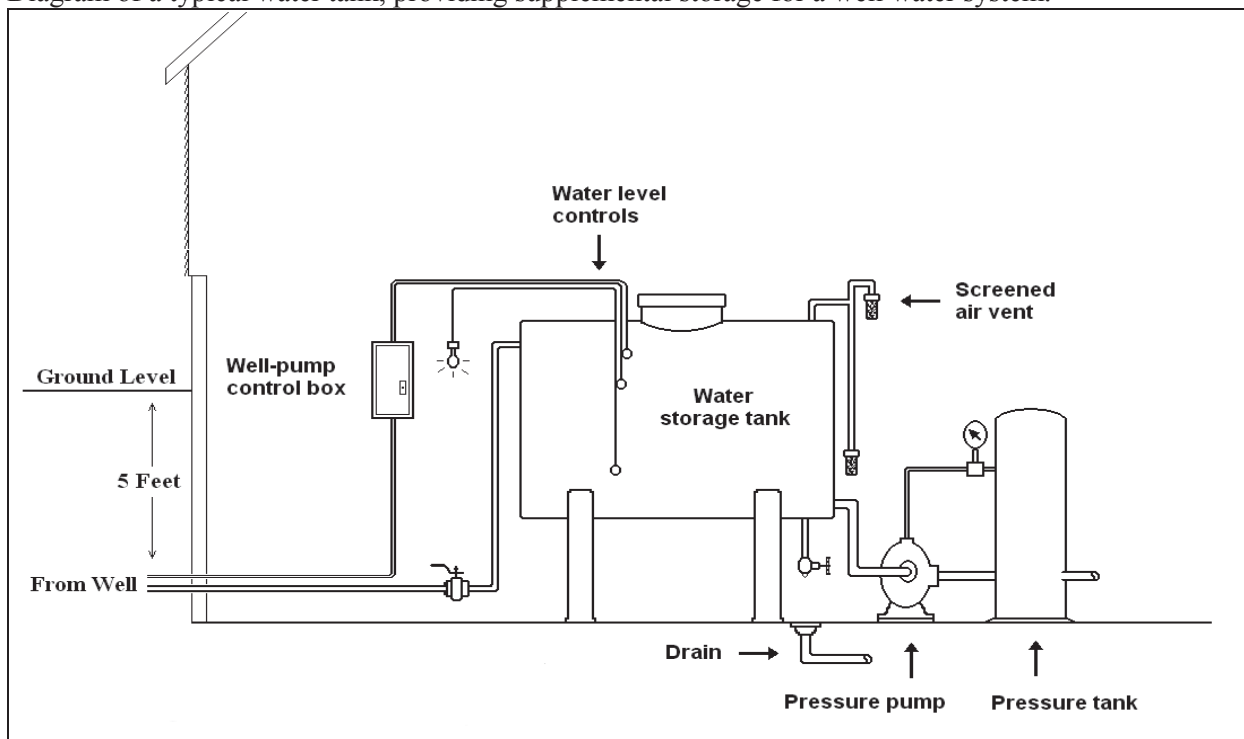

Appendix 5-B can be found at

<http://www.health.state.ny.us/environmental/water/drinking/part5/appendix5b.htm>

For questions concerning this Fact Sheet or a copy of Appendix 5-B:

Contact your Local Health Department or Residential Sanitation Section
 Bureau of Water Supply Protection
 New York State Department of Health
 (518) 402-7650 or FAX (518) 402-7659
 E-mail: bpwsp@health.state.ny.us



NEW YORK STATE DEPARTMENT OF HEALTH

Bureau of Water Supply Protection

Flanigan Square, 547 River Street, Troy, New York 12180-2216

INDIVIDUAL WATER SUPPLY WELLS - FACT SHEET #3 RECOMMENDED RESIDENTIAL WATER QUALITY TESTING

Water quality testing is important for new drinking water wells in addition to periodic evaluation of existing wells. The table below lists the recommended testing parameters for new individual residential water supply wells. These tests should be performed following proper well installation and development, and prior to homeowner use. Beyond these initial tests it is recommended to test for coliform bacteria every year and to periodically re-test water quality for other well-specific constituents of concern.

All samples should be analyzed by a laboratory certified by the NYSDOH Environmental Laboratory Approval Program (ELAP) for testing potable water. A current listing of ELAP laboratories may be accessed at <http://www.wadsworth.org/labcert/elap/elap.html> or by contacting your Local Health Department (LHD).

Analysis *	Recommended MCL (1)(2)	Concerns
Coliform Bacteria	Any positive result is unsatisfactory	Indicator of possible disease causing contamination, e.g. Gastro-intestinal illness
Lead	0.015 mg/l	Brain, nerve and kidney damage (especially in children)
Nitrate	10 mg/l as N	Methemoglobinemia (“blue baby syndrome”)
Nitrite	1 mg/l as N	Methemoglobinemia (“blue baby syndrome”)
Iron	0.3 mg/l	Rust-colored staining of fixtures or clothes
Manganese	0.3 mg/l	Black staining of fixtures or clothes
Iron plus manganese	0.5 mg/l	Rusty or black staining of fixtures or clothes
Sodium	No designated limit (3)	Effects on individuals with high blood pressure
pH	No designated limit	Pipe corrosion (lead and copper), metallic-bitter taste
Hardness	No designated limit	Mineral and soap deposits, detergents are less effective
Alkalinity	No designated limit	Inhibits chlorine effectiveness, metallic-bitter taste
Turbidity	5 NTU	Cloudy, “piggybacking” of contaminants, interferes with chlorine and UV-light disinfection

- (1) **MCL means maximum contaminant level. The MCLs listed are based upon requirements for Public Water Supply systems and are also recommended for use on individual residential systems.**
- (2) **mg/l means milligram per liter (parts per million); NTU means Nephelometric Turbidity Units.**
- (3) **Water containing more than 20 mg/l of sodium should not be used for drinking by people on severely restricted sodium diets. Water containing more than 270 mg/l of sodium should not be used by people on moderately restricted sodium diets.**

***Individual Residential Well Water Supply Quality Testing/HUD Mortgage Requirements (July 27,1995)**

Additional tests are recommended for naturally occurring constituents that appear on a regional basis such as: arsenic, barium, fluoride, methane, radium, radon, and uranium. Additional tests may also be appropriate for contaminants associated with potential sources such as: oil storage facilities, junkyards, gasoline stations, landfills, industry, and active or historic agricultural use. Water samples from older existing residences or residences with corrosive water (i.e., pH less than 6.5) should be tested for lead and copper.

Some LHD's may have their own residential water quality testing requirements. Contact the LHD to determine their required analyses and procedures, and to inquire about any local water quality concerns.

The table below, Reasons to test your Water, is based upon the United States Environmental Protection Agency's (USEPA) publication: "Drinking Water From Household Wells", January 2002.

This table may also be used as a reference for determining additional testing.

Conditions or Nearby Activities:	Test for:
Recurring gastro-intestinal illness ¹	Coliform bacteria, e-coli
Household plumbing contains lead (older homes)	pH, lead, copper
Radon in indoor air or region is radon rich	Radon
Corrosion of pipes, plumbing	pH, lead, copper
Nearby areas of intensive agriculture	Nitrate, pesticides, arsenic, coliform bacteria
Coal or other mining operations nearby	Metals, pH
Gas drilling operations nearby	Sodium, chloride, barium, strontium
Dump, junkyard, landfill, factory, gas station, or dry-cleaning operation nearby	Volatile organic compounds, total dissolved solids, pH, sulfate, chloride, metals
Odor of gasoline or fuel oil, and near gas station or buried fuel tanks	Volatile organic compounds
Objectionable taste or smell	Hydrogen sulfide, pH, metals
Stained plumbing fixtures, toilet tanks or laundry	Iron, copper, manganese, hardness
Salty taste and seawater, or a heavily salted roadway nearby	Sodium, chloride, total dissolved solids
Scaly residues, soaps don't lather	Hardness
Rapid wear of water treatment equipment	pH
Water softener needed to treat hardness	Hardness, manganese, iron
Water appears cloudy, frothy, or colored	Color, detergents, turbidity, total dissolved solids
Reddish-brown films on fixtures or toilet tanks	Iron bacteria, iron, manganese

¹ Individuals with symptoms of gastro-intestinal illness should seek the attention of a medical physician.

Sampling and Treatment

1. Sampling for lead and coliform may give false results if sampling is not done properly. Please contact your Local Health Department for guidance on sampling and interpreting results.
2. If testing shows any level above the recommended MCL, a new water source and/or treatment may be necessary. Please contact your Local Health Department for guidance.

Other sources of information that may be helpful:

American Groundwater Trust, www.agwt.org

American Water Works Association, www.awwa.org

Water Systems Council, www.watersystemscouncil.org

Wellowner, www.wellowner.org

United States Environmental Protection Agency, www.epa.gov

New York Rural Water Association, www.nyruralwater.org

Appendix 5-B, <http://www.health.state.ny.us/environmental/water/drinking/part5/appendix5b.htm>

For questions concerning this Fact Sheet or a copy of Appendix 5-B:

Contact your Local Health Department or
 Residential Sanitation Section
 Bureau of Water Supply Protection
 New York State Department of Health
 (518) 402-7650 or FAX (518) 402-7659
 E-mail: bpwsp@health.state.ny.us



INDIVIDUAL WATER SUPPLY WELLS - FACT SHEET #4 DECOMMISSIONING ABANDONED WELLS

Drinking water wells and other types of wells that are no longer in use can pose safety hazards, especially to small children and pets. These abandoned wells can also serve as pathways for contamination to enter groundwater. Abandoned wells should be properly decommissioned to eliminate these potential hazards. The Department recommends wells be decommissioned using the methods described below.

Well Decommissioning Methods

Prior to abandonment of any well the pump, drop pipe, electrical controls, etc. must be removed from the casing. Leaving these items inside the well casing will cause voids when filling the well, which may increase the possibility of contamination of the well and local aquifers.

- **Driven Points** made of small diameter pipe should be pulled out of the ground. The hole should be filled with grout if possible. The area should be graded so that surface water flows away from the abandoned well location.
- **Dug wells** should be back filled with soil similar to surrounding soils, and compacted to match the surrounding soils. Broken concrete, wood, or other debris should NOT be used as backfill. Prior to back filling, the side wall lining of the dug well should be removed to the full depth if safety can be maintained or to at least four feet below ground level. Dug wells that have penetrated fractured rock should have a cement or grout seal placed in the rock section prior to back filling. After back filling, the area should be graded so that surface water flows away from the abandoned well location.
- **Drilled wells** can be difficult to decommission properly. Whenever practical, the well casing should be pulled out of the ground or overdrilled, and the length of the drill hole sealed with grout. When full casing removal is impractical, the entire length of the drillhole including casing interior should be grouted, and the casing cut off at least four feet below ground. Well casings that penetrate multiple aquifers should be perforated prior to pressure grouting the interior. After back filling, the area should be graded so that surface water flows away from the abandoned well location.
- **Artesian wells, wells in creviced rock such as limestone, and wells penetrating multiple aquifers** pose the most difficult decommissioning procedures. The Department recommends that well drillers follow the procedures found in American Water Works Association Standard A100 "AWWA Standard for Water Wells".

Using Grouts

The proper use of grout in decommissioning a well can provide the best protection against contaminant migration. Effective grouting requires careful placement to ensure no voids are left in the well and that the seal is complete. Registered well drillers can ensure proper grout selection and installation.

Grout is a material that has a low permeability, such as neat cement, bentonite slurry, bentonite chips, bentonite pellets, granular bentonite, or other materials that have equivalent sealing properties. Numerous grout products are available, and a proper match of grout to method is essential.

Regulatory Requirements

In some locations, one or more regulatory agencies and/or municipalities may have specific requirements for decommissioning abandoned water wells. The Local Health Department should be consulted for information on regulatory requirements prior to decommissioning.

State regulations require that anyone engaged in the business of water well drilling in the state of New York first obtain a certificate of registration from the Department of Environmental Conservation (DEC). Water well drilling activities covered by this regulation include well decommissioning.

Registered Well Drillers

The decommissioning of abandoned individual water supply wells can be difficult and dangerous. Though decommissioning may be done by the homeowner, it is strongly recommended that the services of a DEC registered well driller be obtained.

A list of DEC registered well drillers can be found at:

<http://www.dec.ny.gov/cfm/xtapps/WaterWell/index.cfm>

Appendix 5-B can be found at:

<http://www.health.state.ny.us/environmental/water/drinking/part5/appendix5b.htm>

For questions concerning this Fact Sheet or a copy of Appendix 5-B:

Contact your Local Health Department

or

Residential Sanitation Section
Bureau of Water Supply Protection
New York State Department of Health
(518) 402-7650 or FAX (518) 402-7659
E-mail: bpwsp@health.state.ny.us



INDIVIDUAL WATER SUPPLY WELLS - FACT SHEET #5

SUSCEPTIBLE WATER SOURCES

(Well Points, Dug Wells, Springs and Shore Wells)

Individual (residential) water supplies (IWS) need to provide adequate quantities of water fit for consumption and intended uses. A drilled well, located and constructed in accordance with 10NYCRR Appendix 5-B “Standards for Water Wells”, should routinely be the water supply option selected. Well points, dug wells, springs and shore wells are susceptible to contamination from pathogens, spills, etc. and the effects from drought. These water sources may be considered only as a last resort with proper protective measures and, in most cases, will require approval by County or State health department officials through issuance of a specific waiver pursuant to Part 75 of the State Health Department’s Administrative Rules and Regulations or via a county sanitary code waiver provision.

SPECIFIC INFORMATION FOR SUSCEPTIBLE WATER SOURCE TYPES

The following types of water sources typically utilize surface water bodies or shallow groundwater sources. Surface waters can contain bacteria, parasites, viruses and possibly other contaminants and shallow groundwater sources are also at significant risk of contamination. These water sources typically have distinguishing construction characteristics which do not comply with Appendix 5-B requirements and would therefore require a specific waiver or other county approval if utilized.

Well Points

A well point (or “driven point”) is a special type of well installed using a drive point with a built-in screen fastened to the end of a small diameter pipe (usually 1-1/4 to 2 inches) and without a protective outer casing. Well points are installed by pounding, driving or excavating down to the water table. These wells are usually constructed in shallow aquifers with sandy soils, within 10 to 30 feet of the ground surface and use a suction pump to draw water. Single pipe driven point wells under suction are not in compliance with Appendix 5-B and should be avoided.

Dug Wells

A dug well is constructed by making a large diameter excavation into a shallow aquifer, by hand digging or backhoe and shoring the excavation with large diameter concrete rings. (Shoring constructed with stone or brick are not in compliance with Appendix 5-B and should be avoided.) Dug wells are typically less than 15 feet deep and usually use a suction pump to draw water.

Springs

Springs occur where an aquifer discharges naturally at or near the ground surface, and are broadly classified as either rock or earth springs. It is often difficult to determine the true source of a spring (that is, whether it truly has the natural protection against contamination that a groundwater aquifer typically has.) Even if the source is a good aquifer, it is difficult to develop a collection device (e.g., “spring box”) that reliably protects against entry of contaminants under all weather conditions. (The term “spring box” varies, and, depending on its construction, would be equivalent to, and treated the same, as either a spring, well point or shore well.) Increased yield and turbidity during rain events are indications of the source being under the direct influence of surface water.

Shore Wells

“Shore wells” (also known as “infiltration galleries” or “cassion wells”) are shallow wells influenced by surface water and are installed near a waterbody in a shallow aquifer that is directly connected to surface water. Shore wells can also be shallow subsurface devices adjacent to a water body, installed to collect water through a covered stone-filled trench or similar arrangement that drains surface water to a “storage” well or tank. Soils surrounding shore wells provide minimal filtration. The risk of contamination of these water sources can be similar to those of surface water sources.

ADDITIONAL CONSIDERATIONS AND RECOMMENDATIONS

The use of susceptible sources as described above is discouraged. A properly installed drilled well should be considered first before considering the use of a susceptible source. As a last resort, when the use of a susceptible source is considered, the following is recommended:

Well Points, Dug Wells and Springs

Where shallow ground water aquifers exist, well points, dug wells and springs can be allowed if they are installed by a certified New York State Department of Environmental Conservation (NYS DEC) registered water well contractor and, in most cases, require issuance of a specific waiver by the LHD or county sanitary code approval as needed. For these sources, installation of appropriate treatment should be considered (e.g., continuous disinfection). For springs, an engineering report, which may include a hydrogeologic study, should also be provided to assure that the water source is satisfactory.

Shore Wells

In cases where satisfactory groundwater cannot be developed according to Appendix 5-B standards, a specific waiver or approvals via county sanitary code can be requested for development of a shore well. All such requests should demonstrate unsatisfactory availability of groundwater via an engineering report or other evidence (such as a hydrogeologic study) deemed acceptable by the approval authority. Since shore wells provide minimal natural filtration of surface water, all requests should include proposed design, treatment (including filtration and continuous disinfection) and an operation, maintenance and monitoring plan developed by a professional engineer. After health department approval, the shore well needs to be installed by a certified NYS DEC registered water well contractor. Inclusion of a deed amendment as a condition on the specific waiver approval should also be considered. A professional engineer should certify that the construction and installation of treatment has been provided according to plans.

WATER QUALITY TESTING

Water quality testing is important for all drinking water wells to identify water characteristics and determine treatment needs. See NYS DOH Fact Sheet #3, "Recommended Residential Water Quality Testing" for a recommended minimum list of parameters to test for. It is recommended to test for coliform bacteria every year and to periodically re-test water quality; this is particularly important for water supplies susceptible to contamination.

COUNTY OR STATE HEALTH DEPARTMENT APPROVAL PROCESS REQUIRING A SPECIFIC WAIVER FROM PART 75 OR A COUNTY SANITARY CODE PROVISION

The local health official (see below) for the geographic area where the property that will utilize the water source is located should be contacted for information about how to apply for a specific waiver or other county sanitary code approval. **It is recommended that, before an application for a waiver or other approval is submitted, the local health official be contacted regarding conceptual acceptability of the proposal.** A specific waiver or other approval **IS NOT** intended as a device for routinely approving individual water sources that do not meet state standards. It is intended to provide administrative flexibility to address rare cases when hardships exist and/or other circumstances that make it impractical to meet Appendix 5-B standards.

ADDITIONAL INFORMATION:

Appendix 5-B can be found at:

<http://www.health.state.ny.us/environmental/water/drinking/part5/appendix5b.htm>

NYSDEC registered well drillers can be found at: <http://www.dec.ny.gov/cfm/xtapps/WaterWell/index.cfm>

For a copy of Appendix 5-B or other Fact Sheets or questions concerning this Fact Sheet:

Contact Your Local Health Department Official

or

Residential Sanitation Section
Bureau of Water Supply Protection
New York State Department of Health
(518) 402-7650 or FAX (518) 402-7659
E-mail: bpwsp@health.state.ny.us



NEW YORK STATE
DEPARTMENT OF HEALTH

Concerns About Surface Water as a Drinking Water Source



The New York State Department of Health wants to remind people that there are risks from using water from any surface water source as drinking water, unless that water is properly filtered and disinfected. Water from rivers, lakes, ponds and streams can contain bacteria, parasites, viruses and possibly other contaminants. To make surface water fit to drink, treatment is required.

Remember, we use our drinking water in many different ways. We use it as a beverage, but also make ice cubes, mix baby formula, wash fruits and vegetables, and brush our teeth. If the water is contaminated, this may put you at risk. Depending on the kind of contamination, it may also be a concern to wash dishes, wash hands, shower or bathe.

Public water systems are required to treat, disinfect and monitor water quality for their customers. A public water treatment system is well designed and employs trained technicians to test and maintain water quality. If you are not on a public water system and use surface water as your water supply source, please contact your local health department* for advice. They can talk to you about developing another source of drinking water in your area. If there are no other choices, then they can discuss the treatment options for your surface water source. In the meantime, avoid the use of surface water for your drinking water needs. You should use bottled water or disinfect small batches of water by bringing it to a rolling boil for one – two minutes.

Although the New York State Health Department cannot recommend specific treatment systems or businesses that install them, we would be glad to talk to you about options. For general questions regarding drinking water, call 1-800-458-1158, extension 27650.

Fact Sheet

*You can find the number for the local health department in your phone book, or call the toll-free number listed above for help in locating the office nearest to you.

This page intentionally left Blank

Appendix C

Acceptable Gravelless and Alternate Aggregate Products

(Note: The list will be updated as needed)

This page intentionally left Blank

GRAVELLESS and ALTERNATE AGGREGATE PRODUCTS

February 2015

The NYS Department of Health has determined that the following products comply with 10 NYCRR Appendix 75-A.

This Department does not approve proprietary products, but will review products as a courtesy.

Manufacturer	Product	Trench Length Design (75-A: Tables 4A or 4B) ^{1,2}
Advanced Drainage Systems (ADS) www.ads-pipe.com	GEO-Flow Pipe Leaching System GEO-Flow geotextile sand filter system	25% 6.0 ft ² /ft rating
Cultec www.cultec.com	Contractor EZ-24 Chamber Contractor 100 Chamber Contractor 125 Chamber	1:1 25% 25%
Eljen Corporation www.eljen.com	Geotextile Sand Filter (Type B) Geotextile Sand Filter (Model A425)	6.0 ft ² /ft rating 6.0 ft ² /ft rating
Infiltrator Systems www.infiltratorsystems.com	ATL System ATL Geotextile Sand Filter System Equalizer 24 Quick 4 Equalizer 24 Quick4 Equalizer 24 HD Quick4 Equalizer 24 LP Quick 4 Equalizer 36 Quick4 Plus Equalizer 36 LP Quick4 Standard Quick4 Plus Standard Quick4 Plus Standard LP High Capacity H-20 EZ Flow 1202H EZ Flow 1203T EZ Flow 1003T BioDiffuser 15" Narrow (Bio 2) BioDiffuser 22" Narrow (Bio 3) ARC 18 Chamber* ARC 24 Chamber* ARC 36 Chamber* ARC 36 HC Chamber* ARC 36 HC H-20 Chamber* BioDiffuser 11" Standard (34" wide) BioDiffuser 16" High Capacity H-20 Flowtech by Infiltrator: FTS 122H-1 Flowtech by Infiltrator: FTS 123T-1 Flowtech by Infiltrator: FTS 103T-1	25% 6.0 ft ² /ft rating 1:1 1:1 1:1 1:1 25% 1:1 25% 25% 25% 25% 25% 1:1 25% 25% 1:1 25% 25% 25% 25% 25% 1:1 25% 25%
*ARC Chambers may be marketed as Advanced Drainage Systems (ADS) products; ADS is owned by Infiltrator.		
Geomatrix LLC www.geomatrixsystems.com	GST Leaching System	1:1
Presby Environmental www.presbyeco.com	Enviro-Septic System AES geotextile sand filter system	25% 6.0 ft ² /ft rating
Modern Landfill www.moderncorporation.com	Tire Derived Aggregate (TDA) ³	1:1
Casing, Inc. Jim.fabrizio@casingsinc.com	Tire Derived Aggregate (TDA) ³	1:1

¹ Reductions in total linear feet based on criteria in Appendix 75-A, subsection 75-A.8(c)

² The trench length reductions are not applicable at properties located within the New York City Watershed

³ The TDA product meets criteria established in Section 75-A.8(b)(3)(v)

Note: The above list is not an endorsement of any of the products by the NYS Department of Health, nor is it intended to represent a comprehensive list of all products that comply with 10 NYCRR Appendix 75-A. This list will be occasionally updated as new product specifications are reviewed. The use of these products may be subject to approvals by local government agencies, including local health departments, watersheds or other local agencies.

This page intentionally left Blank

Appendix D

Percolation Test Instructions and Data Sheet

This page intentionally left Blank

Development Site: _____ (T/V/C): _____ County: _____

Date: _____ Tests Conducted By: _____

Weather Conditions: _____

Test Hole No.	Test Hole Depth (inches)	Lot No.	Soil Profile Description and Groundwater Depth (if identified)	Presoaking Date & Time	Time	Percolation Test					
						1	2	3	4	5	6
					End						
					Begin						
					Result						
					End						
					Begin						
					Result						
					End						
					Begin						
					Result						
					End						
					Begin						
					Result						
					End						
					Begin						
					Result						

Begin time, end time, and result in minutes for a water elevation change from 6" to 5" above the bottom of the test hole.

INSTRUCTIONS

Procedure:

- 1) At least two percolation tests shall be performed within the proposed absorption area. At least one percolation test should also be performed within the proposed absorption system expansion area.
- 2) Dig each hole with vertical sides approximately 12 inches in diameter. If an absorption field is being considered, the depth of test holes should be 24 to 30 inches below final grade or at the projected bottom of trenches in shallower/deeper systems based upon test hole evaluation. The sides of the percolation holes should be scraped to avoid smearing. Place washed aggregate in the lower two inches of each test hole to reduce scouring and silting action when water is poured into the hole.
- 3) Presoak the test holes by periodically filling the hole with water and allowing the water to seep away. This procedure should be performed for at least four hours and should begin one day before the test (except in clean coarse sand and gravel). After the water from the final presoaking has seeped away, remove any soil that has fallen from the sides of the hole.
- 4) Pour clean water into the hole, with as little splashing as possible, to a depth of six inches above the bottom of the test hole.
- 5) Observe and record the time in minutes required for the water to drop from the six-inch depth to the five-inch depth.
- 6) Repeat steps (4) and (5) a minimum of three times until the time for the water to drop from six inches to five inches for two successive tests is approximately equal (i.e., ≤ 1 min. for 1-30 min./inch, ≤ 2 min. for 31-60 min./inch). The longest time interval to drop one inch will be taken as the stabilized rate of percolation.
- 7) Percolation test results shall be consistent with soil classification and if different results are obtained for multiple holes in a proposed absorption area, the slowest stabilized rate shall be used for system design.

I _____, the undersigned certify that the percolation tests were conducted by me or under my direction in accord with the above procedure. The data and results are true and correct.

Date: _____

Signature: _____

License No. (P.E., R.A., L.S.) _____

Appendix E

Specific Waiver Application Forms

Includes:

Specific Waiver Application.....

DOH 4345: Residential On-Site Water Supply Systems – New or Replacement.....

DOH 4346: Residential On-Site Wastewater Treatment Systems

This page intentionally left Blank

Applicant (Owner) _____ TELEPHONE #, EMAIL _____

Address _____
STREET TOWN, VILLAGE, CITY COUNTY ZIP

Site Location _____
STREET TOWN, VILLAGE, CITY COUNTY ZIP

This information is submitted in support of the application for specific waiver from compliance with one or more standards of 10NYCRR, Appendix 5-B, "Standards for Water Wells" for a:

- New Well
- Replacement Well

1. The proposed well cannot meet the standards of Appendix 5-B for the following reason (s):

- Separation distance cannot be achieved (Section 5-B.2, Table 1).
- Casing length is less than 20 feet (Section 5-B.3(b)(4)(ii))
- Other: Section 5-B _____

2. The following measures are proposed and/or site conditions exist that will mitigate noncompliance:

- Deeper well casing and grouting
- Grading/topography
- Remove or relocate source of contamination
- Existing site conditions are protective of the water supply
- Treatment
- Other _____

3. Please submit information supporting application for specific waiver from provisions of Appendix 5-B which may include a description of existing well problems such as poor water quality, low yield, source susceptible to contamination, damage to well or appurtenances, or contamination. Please include a detailed site plan, hydrogeologic and site evaluation details, and water test report and any other information to support request for waiver.

4. Signature of Applicant and Design Professional /Well Driller

I _____ (Applicant) understand that the water supply system proposed does not meet all standards described in 10NYCRR Appendix 5-B "Standards for Water Wells," and accept the system as proposed. I understand that the well water should be tested for quality prior to use of the well and/or occupancy of the property.

SIGNATURE

DATE

I _____ (Professional Engineer, Registered Architect, Well Driller) acknowledge that this application for waiver is necessary because it is not practical to comply with the standards of 10NYCRR, Appendix 5-B, "Standards for Water Wells," on this property. In my professional opinion, existing hydrogeologic conditions at the site and/or proposed protective measures for the well described in this application will provide an acceptable degree of protection intended by the standards of Appendix 5-B. I also acknowledge and recommend that the well water will be tested for quality prior to occupancy.

SIGNATURE

DATE

NYS PE LICENSE #

NYSDEC REGISTERED DRILLER #

For Health Department Use Only

Based upon the information provided in this application to waive the referenced standards of Appendix 5-B and in accordance with 10NYCRR Section 75.3 and 75.6(b), the waiver requested is hereby:

- Approved: Install as proposed
- Approved: Install with the following conditions: _____
- Denied, for the following reasons: _____

This waiver may be revoked if any proposals are modified or site conditions change that were considered for approving this waiver.

HEALTH DEPARTMENT REPRESENTATIVE

SIGNATURE

DATE

Completing the Specific Waiver Application: Individual Water Supplies

Applicability

This Specific Waiver application form is intended for an applicant (property owner) to present information for consideration by the Health Department having jurisdiction to approve a new or replacement residential onsite water supply that does not comply with one or more standards of Appendix 5-B, "Standards for Water Wells". For a new well the proposal must be submitted by a P.E. For replacement wells, the proposal can be provided by a NYSDEC Registered Driller. However, a P.E. may be required at the Health Department's discretion.

**Before a well is drilled that does not meet standards, a specific waiver must be obtained. If there is an emergency situation that may require the installation of a replacement well on short notice, contact the local Health Department having jurisdiction.*

Background

The responsible city, county, or district health official may grant a Specific Waiver in accordance with 10NYCRR Part 75 from a provision of Appendix 5-B when all of the following circumstances apply:

1. Conditions at the particular site make it impractical to comply with these standards.
2. Disapproval will result in a hardship.
3. The well will not create a health hazard.
4. Appropriate protective measures exist or are applied to mitigate nonconformance.

A specific waiver is NOT required for wells that are otherwise subject to DOH or LHD approvals (such as realty subdivisions) or permits. However, standards not met for such systems should be detailed on the approved plans and/or in the permit issued. A Specific Waiver is NOT intended as a device for routinely approving residential wells that do not meet State standards. It is intended to provide administrative flexibility to resolve individual cases when hardships and/or other circumstances exist that make it impractical to meet applicable standards, using the following guidelines. The Specific Waiver application shall provide information and background about the site conditions and detail the proposal so that the Health Department is able to determine whether to approve or deny the application. The Health Department representative may ask for additional information to be submitted to make a determination.

General Information

Provide the applicant's current mailing address and contact information. Also provide the address of the property the specific waiver is being applied for, even if it is the same as the mailing address.

Reasons for Noncompliance

Check the applicable reasons(s) for which the waiver is requested. If not already listed, include the specific standard in the space provided and provide a brief explanation (e.g., the well will be 90-feet from the onsite wastewater treatment system). More detailed information can be attached as needed to detail the proposal and/or document hardship.

Protective Measures/Site Conditions

Check all applicable additional protective measure(s) proposed and/or existing site conditions that will mitigate the well's noncompliance with Appendix 5-B standards. Any other protective measures can be listed after "other" in the space provided. Provide a brief description on the application form (e.g., the well is 300-feet deep with 60-feet of casing and grouted the entire length of the casing). Detailed explanations can be attached to the application.

Supporting Information

Any additional information can be listed after "other" in the space provided. Include additional information on a separate sheet. The amount and or detail of information required by the Health Department representative may depend on the complexity of the site conditions. To obtain a specific waiver, the applicant must demonstrate that the water supply proposed is acceptable and is not likely to pose a health hazard.

Detailed Site Plan contents may include some or all of the following: surveyed plat, accurate location of onsite and neighboring offsite (if applicable) sources of contamination site topography, drainage features and any pertinent physical features. Appendix 5-B, Table 1, lists required separation distances from a number of contaminant sources.

Hydrogeologic Evaluation contents may include some or all of the following: water table depth, groundwater flow direction, nearby surface waters, site geology, aquifer characteristics, water quality data, well yield, etc. Information may be submitted based upon surrounding (known) well conditions or actual onsite tests.

Acknowledgement of Risks

The applicant (property owner) and a P.E. or NYSDEC Registered Driller (for some replacement wells) are required to sign the Specific Waiver application and acknowledge the risks that may be associated with the water supply to serve the property.

A *NYSDEC Well Completion Report* is required by the Environmental Conservation Law (ECL) to be completed and submitted to NYSDEC and the property owner. If a waiver is issued, a copy of this Report shall be submitted to the Health Department.

Health Department Representative Response

The Health Department representative will approve; approve with conditions; or deny the Specific Waiver application. the determination will be sent to the applicant and a copy of the determination and all information submitted with the application will be retained.

Applicant (Owner) _____ TELEPHONE #/EMAIL _____

Address _____
STREET TOWN, VILLAGE, CITY COUNTY ZIP

Site Location _____
STREET TOWN, VILLAGE, CITY COUNTY ZIP

1. This information is submitted in support of the application for specific waiver from the standards of 10NYCRR Appendix 75A, Wastewater Treatment Standards - Residential On Site Systems.

Proposed design cannot meet standards of Appendix 75-A for the following reasons:

- Separation distance cannot be achieved (see 75-A.4(b), Table 2, Separation Requirements)
- Excessive slope (see 75-A.4a(1), Soil and Site Appraisal)
- Proposed design and or technology
- Other _____

2. Provide a brief description of design criteria which will mitigate noncompliance with requirements of Appendix 75-A . Include a detailed design, record of soil/site investigation and evaluation and a site plan which depicts conditions of concern existing on parcels abutting the site location including but not limited to location of wells, water bodies and wetland.

3. Signature of Applicant and Professional Engineer/Registered Architect

I _____ (Applicant) acknowledge that this request for waiver is necessary because an on-site wastewater treatment system at this property cannot meet the referenced standards of 10NYCRR, Appendix 75-A. I accept the system design as proposed.

SIGNATURE

DATE

I _____ (Professional Engineer/Registered Architect) acknowledge that this request for waiver from standards of 10NYCRR, Appendix 75-A is necessary because one or more conditions prevent construction of an on-site wastewater treatment system that is compliant with standards of Appendix 75-A. By my signature, the proposed design will provide a degree of protection equivalent to the intent of Appendix 75-A and will not result in an increased risk to public and environmental health.

SIGNATURE

DATE

NYS LICENSE #

For Health Department Use Only

Based upon the information provided in this application to waive the referenced standards of Appendix 75-A and in accordance with 10NYCRR Section 75.3 and 75.6(b), the waiver requested is hereby:

- Approved: Install as proposed
- Approved: Install with the following conditions: _____
- Denied, for the following reasons: _____

This waiver may be revoked if any proposals are modified or site conditions change that were considered for approving this waiver.

HEALTH DEPARTMENT REPRESENTATIVE

SIGNATURE

DATE

Completing the Specific Waiver Application: Residential Onsite Wastewater Treatment Systems

Applicability

This Specific Waiver application form is intended for use by the applicant (property owner) and the applicant's engineer to present information for consideration by the Health Department having jurisdiction to approve a new onsite wastewater treatment system (OWTS) that does not comply with one or more standards of Appendix 75-A, "Wastewater Treatment Standards – Residential Onsite Systems". *A specific waiver shall be obtained before construction of the onsite wastewater treatment system.*

Background

The responsible city, county, or district health office may grant a 10NYCRR Part 75 Specific Waiver from a provision(s) of 10NYCRR Part 75, Appendix 75-A, only under the following circumstances:

1. Conditions at the particular site make it impractical to comply with these standards or
2. Disapproval will result in a significant hardship.
3. Appropriate protective measures to mitigate noncompliance are applied;
4. The design is not likely to pose a health hazard or create environmental contamination.

A Specific Waiver IS NOT intended as a device for routinely approving residential onsite wastewater treatment systems that do not meet design standards. It is intended to provide administrative flexibility to resolve cases when hardships exist and/or other circumstances that make it impractical to meet Appendix 75-A standards. *The issuance of a specific waiver is discretionary to the health department.*

The Specific Waiver application shall provide information and background about the site conditions and detail the proposal so that the Health Department is able to determine whether to approve or deny the application. The Health Department representative may ask for additional information to be submitted to make that determination.

General Information

Provide the applicant's current mailing address and contact information. Also provide the address of the property the specific waiver is being applied for, even if it is the same as the mailing address.

Reasons for Noncompliance

Check the applicable reason(s) for which the waiver is requested. If not already listed, include the specific standard(s) in the space provided and provide a brief explanation. More detailed information can be attached as needed or as appropriate.

Proposed Mitigative Design

Provide a brief description of the site characteristics and OWTS design in the space provided. Detailed information (engineer's report) and design plans can be attached to the application.

Supporting Information

The amount and/or detail of information required by the Health Department representative may depend on the complexity of the site conditions. To obtain a specific waiver, the applicant must demonstrate that the onsite wastewater treatment system design proposal is acceptable and is not likely to pose a health or environmental hazard.

Detailed Site Plan contents may include some or all of the following: surveyed plat, accurate location of onsite and neighboring (if applicable) drinking water sources and water courses, site topography, drainage features and any pertinent physical features.

Detailed Design shall be submitted by a NYS licensed P.E. and will clearly identify the OWTS components and locations.

Soil and Site Evaluation shall incorporate the characterization of the existing soils through, at a minimum: percolation tests and test pit evaluation, which identifies soil types and geologic limiting conditions (e.g., groundwater, rock or clay).

Neighboring conditions of concern (if applicable) shall include at a minimum, onsite or nearby: drinking water sources, watercourses or wetlands. Other identified possible areas of concern that could be impacted by the OWTS shall also be identified.

Acknowledgement of Risks

The applicant (property owner) is required to sign the Specific Waiver application and acknowledge the risks that may be associated with the OWTS serving their property. A NYS Professional Engineer (P.E.) is required to provide his or her name and license number on the form and submit the supporting information and stamped design plans on behalf of the applicant.

Health Department Representative Response

The Health Department representative will approve; approve with conditions; or deny the Specific Waiver application. The determination will be sent to the applicant and a copy of the determination and all information submitted with the application will be retained. BWSP suggests that the applicant ensures oversight by obtaining a certification from the Professional Engineer that the wastewater system has been installed as authorized by this Specific Waiver.

Appendix F

NYSDOH Guide “Septic Systems - Operation and Maintenance”

This page intentionally left Blank

Maintain Your System

Regularly pump-out your septic tank when needed.

Keep a record of pumping, inspections, maintenance and repairs.

Map out septic tank and other system components. Either have a map or locate components with permanent stakes. This is useful for accessing the system and will prevent damaging system components when doing home maintenance or yard work.

Don't park or drive heavy vehicles or equipment over the septic system or any of its components.

Don't build structures, such as decks, patios or swimming pools, that would cover the absorption field or limit access to the septic tank and distribution box.

Don't flush or use strong chemicals and bacteria-destroying products, such as drain cleaners, solvents, paint, paint thinners, floor cleaners, sink cleaners, motor oil, antifreeze, pesticides, and photo chemicals. These may disrupt septic tank or absorption system operation. Household bleach, disinfectants, cleansers, antibacterial soaps, when used in normal household applications should not affect system operations.

Don't flush materials that don't easily degrade, such as paper towels, cotton swabs, personal hygiene products, condoms, medications, disposable diapers, coffee grounds, cat litter, cooking fats/oils, facial tissues, dental floss, cigarette butts, plastics, grease or bones.

Avoid septic tank additives. A septic tank that is properly sized and maintained will adequately manage household wastewater without the use of additives.

Avoid garbage disposals or grinders because these substantially increase the accumulation of solids in the septic tank and in the absorption field. If they are used, the septic tank size should be increased and pumped-out more often.

Direct water treatment system discharges to a separate soil absorption system, if possible, to minimize discharges to the septic system. However, as long as the system is well maintained and can accommodate the additional flow, water treatment system discharges can be directed to the septic tank in many cases.

Direct drainage away from the septic system from roof, cellar/footing (sump pump) and surface water run-off.

Plant grass and other shallow-rooted plants over the absorption field. Keep trees and long-rooted plants and shrubs away from the immediate area of the absorption area. Roots can grow into the pipes and clog the system.

Conserve water. Check for defective toilet tank valves, repair leaky fixtures, and install appliances and fixtures that use less water and avoid wasteful practices.

Regularly inspect and maintain any effluent pumps and alarms that may be part of your septic system.

Find Out More

New York State Department of Health
health.ny.gov/environmental/outdoors/septic
Residential Sanitation & Recreational Engineering
Section, Bureau of Water Supply Protection
ph: (518) 402-7650, E-mail: bpwsp@health.state.ny.us

Contact Your Local Health Department
[www.health.ny.gov/environmental/water/drinking/
doh_pub_contacts_map.htm](http://www.health.ny.gov/environmental/water/drinking/doh_pub_contacts_map.htm)

New York State Department of Health

SEPTIC SYSTEM

Operation and Maintenance



A septic system will serve a home for a long time if it is properly located, designed, constructed and maintained. However, even the best designed and installed septic system will eventually fail without periodic maintenance. This guide briefly describes septic system components and how they should be maintained.

Septic System Components

A septic system, also called an onsite wastewater treatment system (OWTS), is made up of a **house sewer drain**, **septic tank**, **distribution box** and **soil absorption (leach) field** (see *Typical Septic System diagram*, right).

❶ **The house sewer drain** collects all the discharge from home fixtures, such as toilets, sinks, showers and laundry and connects to the septic tank.

❷ **The septic tank** collects all the discharges from household plumbing and provides the needed time for wastes to settle or float. The heavy solids settle to the bottom of the tank where they are broken down by bacteria to form sludge. The lighter solids, fats and grease, partially decompose and rise to the surface to form a layer of scum. This process allows the partially treated wastewater to be released to the absorption field.

❸ **The distribution box** evenly distributes wastewater from the septic tank to pipes in the trenches of the absorption field. It is important that each trench receives an equal amount of flow to prevent overloading to one part of the absorption field.

❹ **Trenches** receive partially treated sewage.

❺ **The absorption (leach) field** is a system of trenches and distribution pipes where wastewater is biologically treated by the surrounding soil. The system is partially filled with washed gravel, stone or a gravelless product. The absorption field must be properly sized, constructed and maintained to assure satisfactory operation and long life.

❻ **The vent** permits gases that build up in the plumbing to exit the system.

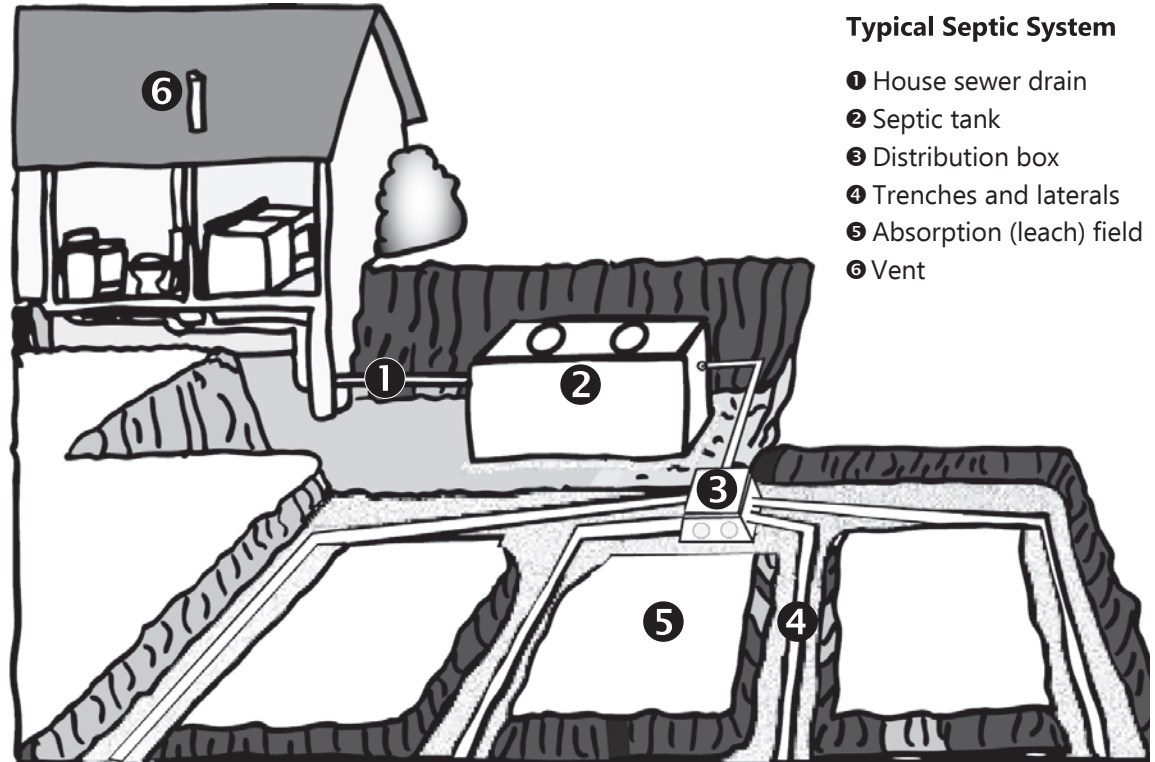

Typical Septic System

- ❶ House sewer drain
- ❷ Septic tank
- ❸ Distribution box
- ❹ Trenches and laterals
- ❺ Absorption (leach) field
- ❻ Vent

Septic Tank Maintenance

A septic tank should be pumped out every two-three years.

A septic waste transporter (septic tank pumper) that is licensed by the New York State Department of Environmental Conservation can inspect, measure tank layers and pump out the tank when necessary.

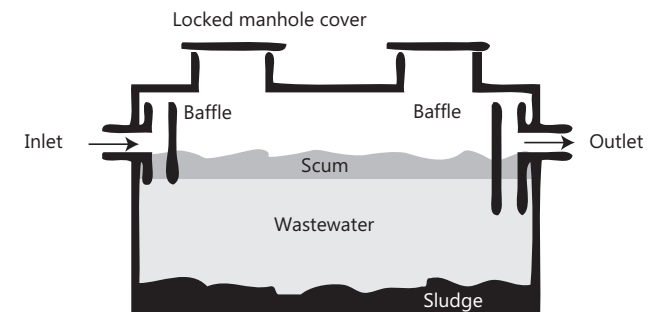

Typical Septic Tank

CAUTION! Never enter a septic tank because it contains toxic gases that can be deadly.

NOTES:

Appendix G

Appendix 75-A

Wastewater Treatment Standards – Residential Onsite Systems

NOTES:

**UNOFFICIAL COMPIATION OF CODES, RULES AND REGULATIONS OF THE STATE OF
NEW YORK TITLE 10. DEPARTMNET OF HEALTH. CHAPTER II. PART 75. STANDARDS
FOR INDIVIDUAL WATER SUPPLY AND INDIVIDUAL SEWAGE TREATMENT SYSTEMS.**

APPENDIX 75-A

WASTEWATER TREATMENT STANDARDS - RESIDENTIAL ONSITE SYSTEMS

(Statutory Authority: Public Health Law, 201(1)(l))

SECTION

- 75-A.1 Introduction
- 75-A.2 Regulation by other agencies
- 75-A.3 Sewage flows
- 75-A.4 Soil and site appraisal
- 75-A.5 House or building sewer
- 75-A.6 Septic tanks and Enhanced Treatment Units
- 75-A.7 Distribution devices
- 75-A.8 Conventional subsurface treatment systems
- 75-A.9 Alternative subsurface treatment systems
- 75-A.10 Other systems
- 75-A.11 Specific Waivers

Effective Date of February 3, 2010

SECTION 75-A.1 Introduction.

(a) This appendix applies to on-site wastewater treatment systems serving residential properties and receiving sewage without the admixture of industrial wastes or other wastes, as defined in Environmental Conservation Law, Section 17-0701, in quantities of less than 1,000 gallons per day (gpd).

(b) Definitions - As used in this Appendix, the following words and terms shall have the indicated meaning:

(1) Absorption Area - an area to which wastewater is distributed for infiltration to the soil.

(2) Absorption Field - the area to which sewage is distributed for infiltration to the soil by means of a network of pipes.

(3) Absorption Trench - a long narrow area which includes a pipe for the distribution of septic tank effluent.

(4) Aerobic Treatment Unit - a system that provides for the biological decomposition of the organic portion of the wastewater by mechanical aeration of the wastewater.

(5) Aggregate - washed gravel or crushed stone 3/4 - 1 1/2 inches in diameter.

(6) Application Rate - the rate at which septic tank effluent is applied to a subsurface absorption area, for design purposes, expressed in gallons per day per square foot (gpd/sq. ft.).

(7) Baffle - a flow deflecting device used in septic tanks and distribution boxes to inhibit the discharge of floating solids, reduce the amount of settleable solids that exit, and reduce the exit velocity of the wastewater.

(8) Building Sewer - that part of the drainage system which extends from the end of the building drain and conveys wastewater to the sewage system or sewer.

(9) Cleanout - an opening providing access to part of the sewage system.

(10) Commissioner - the State Commissioner of Health.

(11) Curtain Drain - a subsurface drain designed and constructed to control groundwater and surface water intrusion into the area of the sewage system.

(12) Design Professional - a person licensed or registered in the State of New York and authorized by the State Education Law to design the systems described in the standards.

- (13) Distribution Device - a device used to uniformly distribute sewage to the absorption area.
- (14) Distribution Line - the perforated Pipe used to distribute wastewater to the absorption area.
- (15) Drinking Water - water whose physical, chemical and biological quality is or is intended to be satisfactory for human consumption, food preparation or culinary purposes.
- (16) Effective Grain Size - a measure of the diameter of soil particles, when compared to a theoretical material having an equal transmission constant. It is the dimensions of that mesh screen which will permit 10 percent of the sample to pass and will retain 90 percent.
- (17) Enhanced Treatment- the biological and physical treatment of wastewater to reduce the amount of biochemical oxygen demand (BOD) and total suspended solids (TSS) of wastewater effluent prior to distribution to an absorption area.
- (18) Enhanced Treatment Unit (ETU)- pre-manufactured structures that provide enhanced treatment of wastewater prior to discharge to a subsurface soil absorption area.
- (19) Gas Baffle - a device on the outlet of a septic tank which deflects gas bubbles away from the outlet and reduces the carry over of solid particles from the septic tank.
- (20) Groundwater - subsurface water occupying the saturation zone from which wells and springs are fed.
- (21) Heavy Equipment - all equipment which would result in the compaction of the design absorption area at a depth equivalent to the design depth of the distribution lines.
- (22) Infiltration - the flow or movement of water into the interstices or pores of a soil through the soil interface.
- (23) Invert - the floor, bottom, or lowest point of the inside cross section of a pipe.
- (24) Local Health Department - a city, county, or part-county department of health or a State Department of Health District Office.
- (25) Percolation - the movement of water through the pores of a soil or other porous medium following infiltration through the soil interface.
- (26) Permeability - a measure of the rate of movement of liquid through soil.

- (27) Responsible Management Entity (RME) - a legal entity with the requisite managerial, financial and technical capacity to ensure long-term management of residential wastewater treatment systems. RMEs may include: sewer districts, utilities, municipal authorities or other entities with the authority to enforce and the capacity to finance the long-term operation and maintenance requirements necessary to ensure residential wastewater treatment systems are functioning properly.
- (28) Scum - the wastewater material which is less dense than water and floats on top of the water.
- (29) Sewage - the combination of human and household waste with water which is discharged to the home plumbing system including the waste from a flush toilet, bath, sink, lavatory, dishwashing or laundry machine, or the water-carried waste from any other fixture, equipment or machine.
- (30) Stabilized Rate of Percolation - the rate corresponding to two consecutive equal or near equal percolation test results.
- (31) Tire Derived Aggregate (TDA) - aggregate manufactured from waste tires to a similar size distribution as conventional gravel or stone aggregate and used as alternative to gravel or stone aggregate in soil absorption areas.
- (32) Useable Soil - unless otherwise stated a soil with a percolation rate from one (1) to sixty (60) min/in with a compatible soil classification.
- (33) Wastewater - any water discharged from a house through a plumbing fixture to include, but not limited to, sewage and any water or waste from a device (e.g., water softener brine) which is produced in the house or property.
- (34) Watercourse - a visible path through which surface water travels on a regular basis. Drainage areas which contain water only during and immediately after a rainstorm shall not be considered a watercourse.
- (35) Watershed - an area of drainage for a body of water that serves as a source of drinking water and for which watershed rules and regulations have been adopted by the Commissioner.
- (36) Well head area - the area surrounding a well which includes the cone of influence (where the drawdown of groundwater causes groundwater flow).
- (37) Wetland - an area(s) of marshes or swamps which have been designated as such by the State Department of Environmental Conservation or other agency having jurisdiction. Marshes or swamps that have not been classified by an agency as a wetland shall not be treated for design purposes as a wetland.

75-A.2 Regulation by Other Agencies.

(a) Where sewage treatment systems are to be located on the watersheds or well head area of public water supplies, the rules and regulations enacted by the State Department of Health for the protection of these supplies must be observed. Where systems are to be located on the watershed of any stream or body of water from which the City of New York obtains its water supply, the approval of the New York City Department of Environmental Protection, Division of Water Resources, must also be obtained.

(b) This appendix establishes the minimum standards acceptable in New York State. Other agencies, such as the Adirondack Park Agency or local health departments may establish more stringent standards. Where such standards have been established, or approval by another agency is required, the more stringent standard shall apply.

(c) A local health department may not adopt standards less stringent than the State standard unless a General Waiver has been issued by the State Commissioner of Health or his designated representative as provided in Part 75, of this Title, or the local health department is otherwise legally authorized to adopt such standards.

(d) When individual sewage systems overlay a drinking water aquifer, local health departments may establish population density limits and minimum lot sizes for residential development with on-site sewage treatment systems.

75-A.3 Sewage Flows.

(a) Roof, footing, garage, cellar and surface water drainage must be excluded from the system. Water softener, water recharge and backwash wastes normally are not to be discharged to the system unless a separate subsurface discharge to an area 250 feet from wells or water courses is unavailable.

(b) Designs for new construction shall be based upon a minimum daily flow of 110 gallons per day per bedroom. Other design flows listed in Table 1 may be applicable for systems receiving wastewater from dwellings equipped with older plumbing fixtures or waterless toilets.

TABLE 1 DAILY DESIGN FLOWS	
Plumbing Fixtures (based on manufactured date)	Minimum Design Flow (gallons per day per bedroom)
Post-1994 Fixtures 1.6 gallons/flush toilets 2.5 gallons/minute faucets & showerheads	110
Pre-1994 Fixtures 3.5 gallons/flush toilets 3.0 gallons/minute faucets & showerheads	130
Pre-1980 Fixtures 3.5+ gallons/flush toilets 3.0+ gallons/minute faucets & showerheads	150
Waterless Toilets (e.g., composter) (graywater discharge only)	75

75-A.4 Soil and Site Appraisal.

(a) Site Investigation.

(1) Areas lower than the 10 year flood level are unacceptable for on-site systems. Slopes greater than 15% are also unacceptable.

(2) There must be at least four feet of useable soil available above rock, unsuitable soil, and high seasonal groundwater for the installation of a conventional absorption field system (75-A.8(b)).

(3) Soils with very rapid percolation rates (faster than one minute per inch) are not suitable for subsurface absorption systems unless the site is modified by blending with a less permeable soil to reduce the infiltration rate throughout the area to be used.

(4) Subsurface treatment systems and components of the sewage system shall be separated from buildings, property lines, waterbodies, utilities and wells, to maintain system performance, permit repairs and reduce undesirable effects of underground sewage flow and dispersion. Table 2 lists the acceptable minimum separation distances from the various components of onsite wastewater treatment systems.

(5) Once the required infiltration area is determined by daily flow, percolation tests and soil evaluation, the required useable area of the property for subsurface treatment can be found. An additional useable area of 50 percent shall be set aside for future expansion or replacement whenever possible.

(b) Separation Requirements:

TABLE 2 SEPARATION DISTANCES FROM WASTEWATER SYSTEM COMPONENTS (IN FEET)				
System Components	Well or Suction Line (e)(g)	To Stream, Lake, watercourse (b), or Wetland	Dwelling	Property Line
House sewer (watertight joints)	25 if cast iron sewer pipe, 50 otherwise	25	3	10
Septic tank or watertight ETU	50	50	10	10
Effluent line to distribution box	50	50	10	10
Distribution box	100	100	20	10
Absorption field (c)(d)	100 (a)	100	20	10
Seepage pit(d)	150 (a)	100	20	10
Raised or Mound system (c)(d)	100 (a)	100	20	10
Intermittent Sand Filter (d)	100 (a)(f)	100 (f)	20	10
Non-Waterborne Systems with offsite residual disposal	50	50	20	10
Non-Waterborne Systems with onsite discharge	100	50	20	10

NOTES:

(a) When wastewater treatment systems are located upgrade and in the direct path of surface water drainage to a well, the closest part of the treatment system shall be at least 200 feet away from the well.

(b) Mean high water mark.

(c) For all systems involving the placement of fill material, separation distances are measured from the toe of the slope of the fill.

(d) Separation distances shall also be measured from the edge of the designated additional usable area as described in Section 75-A.4 (a)(5).

(e) The closest part of the wastewater treatment system shall be located at least 10 feet from any water service line (e.g. public water supply main, public water service line or residential well water service line).

(f) When sand filters are designed to be watertight and collect all effluent, the separation distance can be reduced to 50 feet.

(g) The listed water well separation distances from contaminant sources shall be increased by 50% whenever aquifer water enters the water well at less than 50-feet below grade. If a 50% increase cannot be achieved, then the greatest possible increase in separation distance shall be provided with such additional measures as needed to prevent contamination.

(c) Soil Investigation.

(1) The highest groundwater level shall be determined and shall include the depth to the seasonal high groundwater level and the type of water table - perched, apparent, or artesian.

(2) If a subsurface treatment unit such as an absorption field is planned, at least four feet of useable soil shall be available over impermeable deposits (i.e., clay or bedrock). Highest groundwater level shall be at least two feet below the proposed trench bottom. Where systems are to be installed above drinking water aquifers, a greater separation distance to bedrock may be required by the local health department having jurisdiction. At least one test hole at least six feet deep shall be dug within or immediately adjacent to the proposed leaching area to insure that uniform soil and site conditions prevail. If observations reveal differing soil profiles, additional holes shall be dug and tested. These additional holes shall be spaced to indicate whether there is a sufficient area of useable soil to install the system. Treatment systems shall be designed to reflect the most severe conditions encountered. If the percolation tests results are inconsistent with field determined soil conditions, additional percolation tests must be conducted and the more restrictive tests must be the factor used for the system design.

(3) Test holes for seepage pits shall extend to at least mid-depth and full depth of the proposed pit bottom. At least three feet of useable soil shall exist between the pit bottom and rock or other impermeable soil layer and the highest groundwater level. This shall be confirmed by extending at least one deep test hole three feet below the deepest proposed pit.

(4) A local health department may accept or require other soil tests in lieu of the percolation test when such tests are conducted or observed by local health department personnel.

(d) Soil Percolation Test.

(1) At least two percolation tests shall be made at the site of each proposed sewage treatment system.

(2) For seepage pits, one test shall be conducted at the bottom depth, and the other at half the pit depth. If different soil layers are encountered when digging the test pit, a percolation test shall be performed in each layer with the overall percolation rate being the weighted average of each test based upon the depth of each layer. The local health department having jurisdiction may adopt an alternative procedure for determining the permeability of soil for the installation of seepage pits.

(3) A percolation test is only an indicator of soil permeability and must be consistent with the soil classification of the site as determined from the test holes.

75-A.5 House Sewer.

(a) House sewers are laid on firm foundation at a minimum grade of one-quarter inch per foot preferably without bends. At least one cleanout with a properly fitted plug is to be provided. The house sewer shall allow for venting of gases from the sewage system.

(b) House sewer construction including materials shall comply with the applicable requirements of the State Uniform Fire Prevention and Building Code, Residential Code, Chapter 30, Sanitary Drainage.

(c) A minimum horizontal separation of 10 feet should exist between the house sewer and any water line. Where lines must cross, the water service line shall be at least 12 inches above the house sewer. If a water line must pass below the house sewer, the vertical separation must be at least 18 inches.

(d) Suction waterlines shall never cross under house sewers or any other component of the sewage system.

75-A.6 Septic Tanks.

(a) General information.

(1) Septic tank capacities shall be based upon the number of household bedrooms. An expansion attic shall be considered as an additional bedroom. Table 3 specifies minimum septic tank capacities and minimum liquid surface areas.

TABLE 3 MINIMUM SEPTIC TANK CAPACITIES		
Number of Bedrooms	Minimum Tank Capacity (gallons)	Minimum Liquid Surface Area (sq. ft.)
1, 2, 3	1,000	27
4	1,250	34
5	1,500	40
6	1,750	47

NOTE:
Tank size requirements for more than six bedrooms shall be calculated by adding 250 gallons and seven square feet of surface area for each additional bedroom. A garbage grinder shall be considered equivalent to an additional bedroom for determining tank size.

(2) Septic tank covers shall always be accessible. Where manholes are more than 12 inches below final grade, an extension collar shall be provided over each opening. Extension collars shall not be brought flush with the ground surface unless the cover can be locked to prevent tampering. Driveways or other facilities shall not be constructed above septic tanks unless specially designed and reinforced to safely carry the load imposed.

(b) Design and Installation.

(1) General Requirements. The following applies to all septic tanks regardless of material.

(i) A minimum liquid depth of 30 inches. The maximum depth for determining the allowable design volume of a tank shall be 60 inches. Deeper tanks provide extra sludge storage, but no credit shall be given toward design volume.

(ii) The minimum distance between the inlet and outlet shall be six feet. All tanks shall meet the minimum surface area requirement for the specific design volume specified in Table 3. The effective length of rectangular tanks should not be less than two nor greater than four times the effective width.

(iii) Tanks must be watertight, constructed of durable material not subject to corrosion, decay, frost damage, or cracking. After installation, all septic tanks shall be able to support at least 300 pounds per square foot (psf).

(iv) Tanks with a liquid depth of 48 inches or more shall have a top opening with a minimum of 20 inches in the shortest dimension to allow entry into the tank. Tanks with a liquid depth less than 48 inches shall have a top opening that is at least 12 inches in the shortest dimension.

(v) Tanks shall have inlet and outlet baffles, sanitary tees or other devices to prevent the passage of floating solids and to minimize disturbance of settled sludge and floating scum by sewage entering and leaving the tank. Outlet designs such as gas deflection baffles are strongly recommended in all tanks. Inlet and outlet baffles shall extend a minimum of 12 inches and 14 inches respectively, below the liquid level in tanks with a liquid depth of less than 40 inches, and 16 and 18 inches respectively, in tanks with a liquid depth of 40 inches or greater. The distance between the outlet baffle and the outlet shall not exceed six inches. Baffles shall be constructed of a durable material not subject to corrosion, decay or cracking.

(vi) There shall be a minimum of one inch clearance between the underside of the top of the tank and the top of all baffles, partition and/or tees to permit venting of

tank gases. Multi-chamber and multi-tank systems shall also be designed to permit the venting of tank gases.

(vii) Tanks shall be placed on at least a three inch bed of sand or pea gravel. This will provide for proper leveling and bearing. Additional instructions provided by the manufacturer shall also be followed.

(viii) There shall be a minimum drop in elevation of two inches between the inverts of the inlet and outlet pipes.

(ix) Garbage grinders. An additional 250 gallons of capacity and seven square feet of surface area is required when a garbage grinder can reasonably be expected at the time of construction or in the future. A gas deflection baffle or other acceptable outlet modification, and a dual compartment tank or two tanks in series must also be provided.

(2) Multi-compartment tanks or tanks in series.

(i) Dual compartments are recommended for all tanks and shall be required on all tanks with an interior length of ten feet or more.

(ii) The first compartment or tank (inlet side) shall account for 60 - 75% of the required total design volume.

(iii) The baffle separating the compartments shall extend from the bottom of the tank to at least six inches above the invert of the outlet pipe.

(iv) Compartments shall be connected by a four inch vertical slot at least 18 inches in width, a six inch elbow, or two 4-inch elbows located at a distance below the liquid level equal to one-third the distance between the invert of the outlet and the bottom of the tank. At least one access manhole shall be provided into each compartment.

(v) Tanks in series should be connected by a single pipe with a minimum diameter of four inches.

(vi) The volume and surface area for meeting the requirements of Table 3 shall be based upon the total volume and surface areas of all the tanks and chambers.

(3) Concrete tanks.

(i) Concrete shall have a minimum compressive strength of 2,500 pounds per square inch (psi) at 28 days set; 3,000 psi concrete is recommended as a minimum.

(ii) Wall thickness shall be a minimum of three inches unless the design has been certified by a New York licensed professional engineer as complying with all appropriate requirements for thin-wall construction. All walls, bottom and top shall contain reinforcing to assure support for 300 psf.

(iii) All joints shall be sealed such that the tank is watertight; joints below the liquid level must be tested for watertightness prior to backfilling.

(iv) The walls and floor of cast-in-place tanks shall be poured at the same time (monolithic pour).

(4) Fiberglass and polyethylene tanks. These tanks must meet the following additional requirements:

(i) These tanks shall not be installed in areas where the groundwater level can rise to the level of the bottom of the septic tank.

(ii) Particular care must be taken during installation, bedding, and backfilling of these units so as to prevent damage to tank walls. The manufacturer's installation instructions shall be followed.

(iii) All tanks should be sold by the manufacturer completely assembled. If, because of size, the tank is delivered to the site in sections, all joints shall be sealed with watertight gaskets and shall be tested for watertightness after installation, and prior to backfilling.

(5) Steel tanks. Steel tanks must have a label indicating corrosion protection complying with Underwriters Laboratories, Inc., Standard UL-70 or equivalent.

(6) Enhanced Treatment Units (ETU)

(i) General. ETUs shall have a label indicating compliance with the standards for a Class I unit as described in the National Sanitation Foundation (NSF) International Standard 40 or equivalent testing.

(ii) Design Criteria.

(a) The minimum rated daily capacity of these units shall be 400 gallons or the daily design flow as determined from Table 1, whichever is greater.

(b) ETUs shall have an effluent filtering mechanism as part of the manufactured product or an effluent filter with a label indicating compliance with NSF Standard 46 or equivalent installed on the system outlet prior to discharge to the absorption area.

(c) Unless otherwise specified, the absorption system that follows an ETU shall be designed in the same manner as it would for septic tank effluent.

(d) Absorption areas receiving ETU effluent may be designed with a 33% reduction in the total absorption trench length listed in Table 4A or as calculated from Table 4B, when one of the following situations exist:

(1) ETUs are subject to the jurisdiction of a Responsible Management Entity (RME), or

(2) Local sanitary codes or watershed rules or regulations incorporate the requirement to maintain and service the ETU in accordance with the manufacturer's recommendations.

(e) The trench length reduction, may only be used for conventional absorption trench systems and shallow absorption trench systems.

(f) The trench length reduction may not be further reduced by the trench length reduction allowed for gravelless systems as described in paragraph 75-A.8(c)(3).

(g) The trench length reduction specified above in clause 75A.6(b)(6)(ii)(d) is not applicable at properties located within the New York City Watershed.

75-A.7 Distribution Devices.

(a) Gravity Distribution. The maximum length of absorption lines used in conjunction with gravity distribution shall be 60 feet.

(1) Distribution Box.

(i) For accessibility, it is necessary that the distribution box be located and have a removable cover not more than 12 inches below grade. Where, due to site conditions, a distribution box must be greater than 12 inches below the surface, an extension collar shall be installed to within 12 inches of the surface.

(ii) All outlets from the distribution box shall be at the same level to insure the even distribution of flow.

(iii) To minimize frost action and reduce the possibility of movement once installed, distribution boxes must be set on a bed of sand or pea gravel at least 12 inches thick.

(iv) The drop between inlet and outlet inverts shall be at least two inches. A baffle is required at the inlet side of the box when the slope from the septic tank to the box exceeds 1/2 inch per foot or when siphon dosing is used.

(v) There shall be a minimum two inch clearance between the inverts of the outlets and the bottom of the box to prevent short-circuiting and reduce solids carry-over.

(vi) Distribution boxes may be constructed in place or purchased prefabricated. When concrete is used to construct boxes, it shall have a minimum compressive strength of 2,500 psi at 28 day set.

(vii) Prefabricated boxes may be constructed of concrete, fiberglass, or plastic. The boxes shall be installed in conformance with the manufacturer's instructions in addition to the requirements above.

(2) Serial Distribution.

(i) In serial distribution, an upper distribution line is allowed to fill before the effluent overflows into a lower line. This method is acceptable for use with dosing systems only.

(ii) The connections between distribution lines is made with non-perforated pipe placed in undisturbed soil.

(3) Drop Manholes.

(i) Drop manholes are used on sloping sites to reduce the velocity of flow to lower distribution lines. This system may be used with gravity distribution.

(ii) Baffles at the inlet end of the manhole and approximately four inches from the inlet are required in drop manholes.

(iii) The inverts of all outlets in each manhole shall be at the same level.

(b) Pressure distribution and dosing.

(1) These methods permit the rapid distribution of effluent throughout the absorption system followed by a rest period during which no effluent enters the system. The maximum length of absorption lines used in conjunction with these methods shall be 100 feet.

(i) Pressure distribution utilizes a sewage effluent pump to move the effluent through the pipe network and into the soil. The volume discharged in each cycle will exceed the volume available in the pipe network and will be discharged from the pipe under pressure.

(ii) Dosing involves the use of a pump or siphon to move the effluent into the pipe network. Discharge from the pipe is by gravity. The volume of effluent in each dose should be 75% to 85% of the volume available in the pipe network.

(2) Dosing or pressure distribution is recommended for all systems as it promotes better treatment of wastewater and system longevity.

(3) In absorption fields, single dosing units are required when the total trench length exceeds 500 feet. Alternate dosing units are required when the length exceeds 1,000 feet.

(4) The use of manually operated siphons or pumps is not acceptable.

(5) Pipe used in pressure distribution shall have a minimum diameter of 1.5 inches and a maximum diameter of three inches. Pipe for siphon dosing is sized to conform with the volume of the dose and can range from three to six inches in diameter based upon the volume of each dose. The ends of all pipes shall be capped.

(6) Only pumps designated by the manufacturer for use as sewage effluent pumps shall be used.

(7) Pump chambers shall be equipped with an alarm to indicate malfunction. Siphon dosing systems normally include an overflow to the distribution laterals. Pressure distribution systems shall not be equipped with an overflow.

(8) Pump chambers shall be sized to provide a minimum of one day's design flow storage above the alarm level or a duplex pumping system with audible or visual alarms shall be used.

75-A.8 Conventional Subsurface Treatment Systems.

(a) General for all treatment systems.

(1) All wastewater effluent from septic tanks or ETUs shall be discharged to a subsurface treatment system.

(2) The minimum distances that all treatment system components shall be separated from other site features are listed in Table 2.

(3) Absorption systems shall not be located under driveways, parts of buildings or under above-ground swimming pools or other areas subject to heavy loading. Surface waters shall be diverted from the vicinity of the system.

(b) Absorption Trench Systems.

(1) Site requirements. A minimum of four feet of useable soil shall exist above bedrock and groundwater with a minimum separation of two feet to the lowest part of any absorption trench system.

(2) Design criteria.

(i) The required length of absorption trench is determined from Table 4A based upon the percolation test results and confirmed by the soil evaluation. The maximum trench depth shall be 30 inches below ground surface. The maximum trench width for design purposes shall be 24 inches. Where trenches exceed 24 inches in width, calculations of absorptive area shall be based on a width of 24 inches.

(ii) Adjacent trenches shall be separated by at least four feet of undisturbed soil. Individual trenches shall be constructed parallel to the ground contours with trench bottoms as near level as possible. They need not be perfectly straight but abrupt changes in direction shall be avoided.

TABLE 4A REQUIRED LENGTH OF ABSORPTION TRENCH (IN FEET) (BASED UPON 2 FOOT WIDE TRENCH)															
Percolation Rate min/inch	Daily Flow Rate (gallons per day)														
	2 bedrooms			3 bedrooms			4 bedrooms			5 bedrooms			6 bedrooms		
	220	260	300	330	390	450	440	520	600	550	650	750	660	780	900
1 - 5	92	108	125	138	162	187	184	216	250	230	270	312	275	325	374
6 - 7	110	130	150	165	195	225	220	260	300	275	325	375	330	390	450
8 - 10	123	145	167	184	217	250	245	290	333	306	360	417	367	433	500
11 - 15	138	162	188	207	244	281	275	325	375	344	406	469	413	488	563
16 - 20	158	186	214	236	279	321	315	372	429	393	464	536	472	557	643
21 - 30	184	217	250	275	325	375	367	433	500	459	542	625	550	650	750
31 - 45	220	260	300	330	390	450	440	520	600	550	650	750	660	780	900
46 - 60	245	290	333	367	433	500	489	578	667	612	722	833	734	867	1000
Dosing required if there is 500-foot or more of total trench length															
* Alternate Dosing required if there is 1000-foot or more of total trench length															

TABLE 4B APPLICATION RATES FOR NON-STANDARD DESIGN FLOWS	
Percolation Rate (minutes/inch)	Application Rate (gal/day/sq. ft.)
1 - 5	1.20
6 - 7	1.0
8 - 10	0.90
11 - 15	0.80
16 - 20	0.70
21 - 30	0.60
31 - 45	0.50
46 - 60	0.45
Soil with a percolation rate of less than 1 minute/inch is unsuitable for a conventional system	
Required Area (sq. ft.) = Flow Rate (GPD)/Application Rate (GPD/sq. ft.)	
Required Absorption Trench Length = Required Area (GPD)/2 feet (trench width)	

(3) Materials.

(i) Perforated distributor pipe shall be used in the trenches. Solid (non-perforated) pipe shall be used between the distribution box and the trenches. Perforated pipe shall be made of rigid or corrugated plastic and be labeled as fully meeting ASTM standards for use in septic systems. Corrugated plastic pipe delivered in coils is not to be used unless provision is made to prevent the recoiling or movement of the pipe after installation.

(ii) Aggregate shall mean washed gravel or crushed stone 3/4 - 1 1/2 inches in diameter. Larger diameter material or finer substances and run-of-bank gravel are unacceptable.

(iii) The aggregate shall be covered with a material that prevents soil from entering the aggregate after backfilling, yet must permit air and moisture to pass through. The preferred material for covering the aggregate is a permeable geotextile. Untreated building paper or a four inch layer of hay or straw is acceptable. Polyethylene and treated building paper are relatively impervious and shall not be used.

(iv) Alternate aggregate. Materials may be used as a substitute for conventional gravel or stone aggregate when it can be demonstrated that the material provides at least the equivalent soil infiltration area and storage volume as conventional gravel or stone aggregate. Materials shall also maintain structural integrity and be non-degradable by wastewater effluent.

(v) Tire Derived Aggregate (TDA). Properly manufactured tire chips have physical characteristics similar to conventional gravel or stone aggregate. TDA may be used as a substitute for gravel or stone aggregate on a one-to-one basis, volumetrically, when;

(a) The TDA manufacturer shall have a written case-specific beneficial use determination from the New York State Department of Environmental Conservation (NYSDEC) for use in onsite wastewater treatment systems, and

(b) TDA shall meet the following size and gradation requirements.

(1) Two-inch nominal size, and

(2) Maximum dimension in any direction shall not exceed four inches; minimum dimension in any direction shall not be less than ½ inch, and

(3) Exposed wire shall not protrude more than ½” from the chip, and

(4) Fine particles and foreign materials are prohibited, and

(5) At least 95% of the TDA shall comply with the above specifications.

(4) Construction.

(i) Trench locations and depths should be marked by stakes before the trenches are excavated. The natural surface shall not be significantly disturbed. If the site is regraded or similarly disturbed, the soil shall be allowed to stabilize and new percolation tests conducted.

(ii) The trench depth shall be as shallow as possible, but not less than 18 inches. At least six inches of aggregate is placed below the distribution line and two inches above the line. The earth cover over the aggregate should not exceed 12 inches in order to enhance natural aeration and nitrogen uptake by plant life. Trenches shall be excavated to design depth with bottoms practically level. Heavy equipment shall be kept away from the field because the weight may permanently alter soil characteristics due to compaction, cause trench cave-ins, and/or misalign and break pipe.

(iii) Trench bottoms are to be raked and immediately covered with at least six inches of aggregate.

(iv) Any smeared surfaces on the trench walls are to be raked. Distributor lines are carefully placed on the aggregate and covered with aggregate to a depth of at least two inches over the top of the pipe. Additional aggregate may be required to bring the top of the aggregate to within six to 12 inches of the surface.

(v) In gravity distribution systems, the pipe shall be carefully sloped at between 1/16 inch and 1/32 inch per foot. Grades shall be determined by an engineer's level, transit or carpenter's level.

(vi) After the upper aggregate is placed, the geotextile, untreated building paper, hay or straw is to be immediately installed and the trench backfilled with native soil. If the trenches cannot be immediately backfilled, they should be temporarily covered with an impervious material such as treated building paper to prevent sidewall collapse and siltation into the aggregate.

(vii) The earth backfill is to be mounded slightly above the original ground level to allow for settling and after settlement the entire area should be graded without the use of heavy equipment and seeded with grass.

(c) Gravelless Absorption Systems.

(1) General. Gravelless trench products must be designed to distribute effluent and provide at least the equivalent soil surface area for wastewater treatment as a conventional absorption trench without the use of gravel or stone aggregate. All gravelless systems must also be capable of withstanding typical construction equipment and residential use loads without deformation.

(2) Site requirements. These products may be used as an alternative to conventional gravel or stone absorption trenches in wastewater treatment systems. All other treatment system design requirements shall apply.

(3) Design criteria. Unless otherwise specified, all absorption trench system designs incorporating gravelless products shall have the same trench length as a conventional (24-inch wide) absorption trench as listed in Table 4A or as calculated from Table 4B.

(i) Open-bottom gravelless chambers. Absorption area designs may use a 25% reduction in the total absorption trench length listed in Table 4A or as calculated from Table 4B when the product can demonstrate the following features:

(a) minimum soil infiltration bottom area of 1.6-square feet per linear foot, and

(b) a minimum volumetric capacity of 7.5-gallons per linear foot , and

(c) open sidewall area for aeration and infiltration.

(ii) Gravelless media-wrapped corrugated pipe sand-lined systems. Absorption area designs may use a 25% reduction in the total absorption trench length as listed in Table 4A or as calculated from Table 4B, when the product can demonstrate the following features and installation criteria:

(a) corrugated pipe with a minimum outside diameter of 12-inches, and

(b) wrapped in a media that allows wastewater distribution and prohibits sand infiltration, and

(c) installed with a minimum of 6-inches of washed concrete sand surrounding the pipe.

(iii) Gravelless geotextile sand filter. Absorption area designs may use a trench bottom sizing criteria of 6-square feet per linear foot of trench when the product demonstrates the following features and installation criteria:

(a) a minimum unit width of 3-feet, and

(b) a minimum storage capacity of 12-gallons/linear foot of unit, and

(c) a minimum of 6-square feet per linear foot of geotextile surface area per linear foot of unit, and

(d) installed with 6-inches of washed concrete sand below and on the sides of each unit.

(4) Special Conditions.

(i) The gravelless product trench length reductions specified above in paragraph 75A.8(c)(3) are not applicable at properties located within the New York City Watershed.

(ii) The trench length reduction, may only be used for conventional absorption trench systems and shallow absorption trench systems.

(iii) The gravelless trench length reductions may not be further reduced by the trench length reduction allowed for Enhanced Treatment Units (ETUs) as specified in paragraph 75-A.6 (b)(6).

(5) Construction.

(i) Gravelless absorption system products shall be installed in conformance with the manufacturer's instructions because of the proprietary design of some products.

(ii) The gravelless trench sidewalls shall be separated by a minimum of 4-feet of undisturbed soil.

(iii) All gravelless trenches shall be equal in length. The total trench length shall be increased if necessary.

(d) Deep Absorption Trenches.

(1) Site Requirements. These are used on sites where an useable layer of soil is overlaid by three to five feet of impermeable soil.

(2) Design Criteria.

(i) There shall be at least four feet of useable soil beneath the impermeable layer.

(ii) The required length of absorption trench is determined from Table 4A based upon percolation tests conducted in the underlying soil.

(3) Construction.

(i) Trenches are excavated at least two feet into the useable layer and backfilled with aggregate or coarse sandy material containing a low percentage of fines more permeable than the underlying material to a level 30 inches below the original ground surface.

(ii) An absorption trench system as described in Section 75-A.8(b) is constructed in the upper 30 inches of the excavation.

(e) Shallow Absorption Trenches.

(1) Site Requirements. These systems are used where there is at least two feet but less than four feet of useable soil and/or separation to boundary conditions.

(2) Design criteria.

(i) A minimum two foot separation must be maintained between the bottom of each trench and all boundary conditions.

(ii) The bottom of each trench must not be above the original ground surface.

(iii) Material of the same permeability as the underlying original soil shall be used as fill material. The depth of the fill shall not be greater than 30 inches above the original ground elevation.

(iv) An absorption trench system as described in Section 75-A.8(b) is designed using the percolation of the underlying original soil.

(3) Construction.

(i) Heavy equipment shall be kept out of the absorption area.

(ii) Fill material is carefully placed within the absorption area.

(iii) The edge of the fill material shall be tapered at a slope of no greater than one vertical to three horizontal. On sloped sites a diversion ditch shall be placed on the uphill side to prevent runoff from entering the fill.

(iv) The absorption trench system is constructed in the fill material, extending into the existing natural soil.

(f) Cut and Fill Systems.

(1) A cut and fill system is an absorption trench system installed on sites where impermeable soil overlays a permeable soil.

(2) Site Requirements. Cut and fill systems may be used where all the following conditions are found:

- (i) A soil with a percolation rate slower than 60 minutes per inch, such as clay or clay loam, overlays a useable soil with a percolation rate faster than 60 minutes per inch;
- (ii) At least three feet of useable soil is available beneath the tight soil;
- (iii) All minimum vertical and horizontal separation distances can be maintained as described in Table 2.

(3) Design criteria.

- (i) It shall provide for the removal of the overlaying unusable soil and replacement by soil having a percolation rate comparable with the underlying soil;
- (ii) An absorption trench system is designed as described in Section 75-A.8(b).
- (iii) The required length of absorption trench is based upon the percolation of the underlying soil or the fill material, whichever has the slower percolation (lower permeability).

(4) Construction.

- (i) The area excavated and filled must provide at least a five foot buffer in each direction beyond the trenches.
- (ii) The material placed above the trenches shall have a percolation rate faster than 60 minutes per inch.
- (iii) Original surface material shall not be used as backfill above the trenches.
- (iv) The surface area of the fill system must be mounded and graded to enhance the runoff of rainwater from the system and seeded to grass.

(g) Absorption Bed Systems.

- (1) General. An absorption bed system operates on a principal similar to the absorption trench except that several laterals, rather than just one, are installed in a single excavation. This reduces the effective sidewall infiltration area per linear foot of lateral or leachline.

(2) Site Requirements.

(i) A bed system may be built in soils with a percolation rate between one and 30 minutes per inch. A bed shall not be built where the soil evaluation indicates silty loam, clay loam, or clay.

(ii) Slope of the site shall not exceed eight percent.

(iii) Bed systems are more practical on sites that are long and narrow with a minimal slope.

(iv) All vertical and horizontal separation distance requirements shall be met.

(3) Design Criteria.

(i) Pressure distribution is required for the installation of an absorption bed system. The local health department having jurisdiction may allow the use of siphon dosing on specific sites.

(ii) The maximum width of the bed shall be 20 feet. The maximum length of each lateral from a pressure manifold shall be 100 feet. Utilizing a center manifold system, a bed may then have a maximum length of 200 feet. Laterals for siphon dosing systems in beds are limited to 75 feet.

(iii) The depth of the bed shall be between 18 and 30 inches below original ground level.

(iv) Laterals shall be spaced five (5) feet apart. Two and one-half feet (2 1/2') must be provided between the laterals and the sidewalls. In the maximum width of 20 feet, only four laterals may be installed.

(v) Using pressure distribution with a center manifold, a bed system shall have maximum dimensions of 205 feet by 20 feet.

(vi) The required bed bottom area shall be calculated from the application rates shown in Table 5.

TABLE 5 ABSORPTION BEDS - REQUIRED BOTTOM AREA	
Percolation Rate (minutes/inch)	Application Rate (gal/day/sq. ft.)
1 - 5	0.95
6 - 7	0.80
8 - 10	0.70
11 - 15	0.60
16 - 20	0.55
21 - 30	0.45
30+	Not Acceptable

(4) Construction.

(i) Heavy construction equipment shall be kept outside the proposed bottom area of the bed.

(ii) The required bed bottom area is excavated as level as practical. The bottom and sides of the excavation are hand raked to reduce soil smearing.

(iii) After excavation, a six inch layer of aggregate is placed across the bottom of the bed.

(iv) The laterals are laid level on the aggregate and covered with aggregate to a level two inches above the top of the pipe.

(v) The entire bed area is covered with a permeable geotextile. Untreated building paper or a four inch layer of loose hay or straw may be substituted if a permeable geotextile is unavailable.

(h) Seepage Pits.

(1) General. A seepage pit, sometimes called a leaching pit, leaching pool, or incorrectly a cesspool, is a covered pit with an open-jointed or perforated lining through which septic tank effluent seeps into the surrounding soil.

(2) Site Requirements.

(i) If soil and site conditions are adequate for absorption trenches, seepage pits shall not be used.

(ii) A minimum three foot vertical separation must exist between the bottom of any pit and the high groundwater level, bedrock, or other impervious layer.

(3) Design Criteria.

(i) The required "effective seepage pit area" is obtained from Tables 6 and 7.

(ii) No allowance for infiltration area is made for the bottom area of a pit or the surface area of impervious soil layers (percolation rate slower than 60 minutes/inch).

(iii) The effective diameter of a pit includes the diameter of the lining plus the added diameter provided by the annular ring of aggregate. Any area surrounding the liner with rock smaller than 2 1/2 inches in size shall not be included as part of the effective diameter.

(iv) Effective depth is measured from the invert of the seepage pit inlet to the floor of the pit, with the thickness of impervious layers deducted.

**TABLE 6
SEEPAGE PITS – REQUIRED ABSORPTIVE AREA FOR HOUSEHOLD SYSTEMS
(IN SQUARE FEET)**

Percolation Rate (min/in)	Sewage Application Rate (gpd/sq. ft)	Flow Rate														
		2 bedrooms			3 bedrooms			4 bedrooms			5 bedrooms			6 bedrooms		
		220	260	300	330	390	450	440	520	600	550	650	750	660	780	900
1 – 5	1.20	183	217	250	275	325	375	367	433	500	458	542	625	550	650	750
6 – 7	1.00	220	260	300	330	390	450	440	520	600	550	650	750	660	780	900
8 – 10	0.90	244	289	333	367	433	500	489	578	667	611	722	833	733	867	1,000
11 – 15	0.80	275	325	375	413	488	563	550	650	750	688	813	938	825	975	1,125
16 – 20	0.70	314	371	429	471	557	643	629	743	857	786	929	1,071	943	1,114	1,286
21 – 30	0.60	367	433	500	550	650	750	733	867	1,000	917	1,083	1,250	1,100	1,300	1,500
31 – 45	0.50	440	520	600	660	780	900	880	1,040	1,200	1,100	1,300	1,500	1,320	1,560	1,800
46 – 60	0.45	489	578	667	733	867	1,000	978	1,156	1,333	1,222	1,444	1,667	1,467	1,733	2,000
Over 60		Unsuitable...Use Special Design														

TABLE 7
SEEPAGE PITS (CYLINDRICAL) - DIMENSIONS FOR REQUIRED ABSORPTIVE AREA
(IN SQUARE FEET)

Diameter of Seepage Pit (feet)	EFFECTIVE STRATA DEPTH BELOW FLOW LINE (BELOW INLET)									
	1 FEET	2 FEET	3 FEET	4 FEET	5 FEET	6 FEET	7 FEET	8 FEET	9 FEET	10 FEET
3	9.4	19	28	38	47	57	66	75	85	94
4	12.6	25	38	50	63	75	88	101	113	126
5	15.7	31	47	63	79	94	110	126	141	157
6	18.8	38	57	75	94	113	132	151	170	188
7	22	44	66	88	110	132	154	176	198	220
8	25.1	50	75	101	126	151	176	201	226	251
9	28.3	57	85	113	141	170	198	226	254	283
10	31.4	63	94	126	157	188	220	251	283	314
11	34.6	69	104	138	173	207	242	276	311	346
12	37.7	75	113	151	188	226	264	302	339	377

Absorptive Area for Cylinder = πDh
Absorptive Area for Rectangle = $(2W + 2L)h$
h – effective depth (Invert of inlet to bottom of seepage pit)
D – outside diameter in ft.
W – outside width in ft.
L – outside length in ft.
 $\pi = 3.14$

(v) Linings may be precast concrete, cast-in-place concrete, or built in place with unmortared hollow cinder or concrete blocks. Concrete shall have a minimum compressive strength of 2,500 psi and 3,000 psi is recommended. Material with comparable structural strength, determined in accordance with commonly accepted sewage construction standards, principles or practices, may be allowed on an individual basis to prevent unreasonable hardship, provided public health is not prejudiced.

(vi) The separation between the outside edges of seepage pits shall be three times the effective diameter of the largest pit. This separation is measured as the undisturbed soil between pit excavations.

(vii) Pits shall be designed with sufficient structural stability to withstand lateral soil forces as well as vertical loads.

(4) Construction.

(i) Laterals leading to each seepage pit must be at least four inches in diameter with a minimum slope of 1/8 inch per foot.

(ii) Seepage pits shall not be connected in series. A distribution box shall be required where more than one seepage pit is installed.

(iii) The pit excavation is to be raked to minimize sidewall smearing that may occur and reduce infiltration capacity. If groundwater is encountered, the pit shall be backfilled with the original soil to a level at least three feet higher than maximum groundwater and adjustments made in the pit dimensions.

(iv) The linings are placed upon a concrete block, poured concrete, or precast footing and surrounded by a six inch minimum annular ring of large aggregate (2 1/2 - 4 inches in size).

(v) The rock is covered to prevent soil from filling the void spaces. Building paper, a four inch thick layer of hay or straw may be used.

(vi) The seepage pit cover shall be structurally sound and capable of supporting 300 pounds per square foot at the weakest point. Covers may be precast concrete or cast-in-place and shall be reinforced. A manhole with an opening of at least 20 inches in the shortest dimension shall be provided.

75-A.9 Alternative Systems.

(a) General. Alternative subsurface treatment systems described in this section can be installed when site conditions exist that do not allow the use of conventional subsurface treatment systems.

(b) Raised System.

(1) A raised system is an absorption trench system constructed in fill material with acceptable permeability placed above the natural soil on a building lot.

(2) Site Requirements. A raised system may be used where all the following conditions are found:

(i) There is at least one foot of original soil with a faster than 60 minutes percolation rate, above any impermeable soil layer or bedrock, but not more than two feet.

(ii) The maximum high groundwater level must be at least one foot below the original ground surface.

(iii) Slopes shall not exceed 15%.

(iv) All minimum vertical and horizontal separation distances can be maintained as described in Table 2.

(3) Design Criteria.

(i) Percolation tests shall be conducted in the fill material at the borrow pit and after placement and settling at the construction site. The slower percolation rate of these tests shall be used for design purposes.

(ii) The total area beneath the absorption trenches, extending 2.5 feet in all directions from the outer edge of all trenches, is defined as the basal area. The minimum size of the basal area of the raised system shall be calculated based upon 0.2 gpd/sq.ft. A conventional absorption trench system as described in subdivision 75-A.8 (b) is to be designed using the percolation rate of the fill material. The use of slowly permeable soils for the fill material will result in a trench system that will have a basal area larger than the minimum area calculated using 0.2 gpd/sq.ft.

(iii) The minimum size of the basal area of a raised system designed to receive effluent from an ETU located in an area described in subclauses 75-A.6 (b)(6)(ii)(d)(1) or (2), shall be calculated based upon 0.3 gpd/sq ft. A conventional absorption trench system as described in subdivision 75-A.8 (b) is to be designed to distribute effluent evenly over the fill material basal area.

(iv) Sufficient fill material with a percolation rate of between 5 - 30 min/in is required to maintain at least two feet separation between the proposed bottom of the trenches and any boundary condition such as groundwater, bedrock, clay or other relatively impermeable soil or formation.

(v) The edge of the fill material shall be tapered at a slope of no greater than one vertical to three horizontal with a minimum 20 foot taper.

(vi) Horizontal separation distances shall be measured from the outside edge of the taper.

(vii) The system shall incorporate siphon dosing, pump dosing or pressure distribution. Gravity distribution may be allowed where both of the following conditions are met:

(a) The local health department has a program incorporating site evaluation, system design approval, and construction inspection/certification, and

(b) A minimum of two feet of fill material with a percolation rate of 5 - 30 min/in shall be placed between the bottom of the trenches and the existing ground.

(viii) Curtain drains may be used to intercept and carry underground water away where high groundwater levels exist. Curtain drains shall be upslope from the system and at least 20 feet from the toe of slope of the fill material.

(4) Construction.

(i) Heavy construction equipment shall not be allowed within the area of the system. The underlying soil shall be undisturbed although the surface may be plowed with at least a double bottomed blade/furrow plow and the furrow turned upslope.

(ii) A system shall not be built in unstabilized fill material. The fill material shall be allowed to settle naturally for a period of at least six months to include one freeze-thaw cycle, or may be stabilized by mechanical compaction in shallow lifts if a fill material consisting of only a granular sand or sandy loam is used.

(iii) The absorption trenches shall be constructed in the fill material.

(iv) The entire surface of the system including the tapers shall be covered with a minimum of six inches of topsoil, mounded to enhance the runoff of rainwater from the system and seeded to grass.

(v) On sloping sites a diversion ditch or curtain drain shall be installed uphill to prevent surface water runoff from reaching the raised system area.

(c) Mounds.

(1) General. A mound system is a soil absorption system that is elevated above the natural soil surface in a suitable fill material. It is a variation of the raised bed utilizing sandy fill material but not requiring a stabilization period prior to the construction of the absorption area. On sites with permeable soils of insufficient depth to groundwater or creviced or porous bedrock, the fill material in the mound provides the necessary treatment of wastewater. The overall size of the mound system will normally be substantially smaller than a raised bed.

(2) Site Requirements. A mound system may be used where all the following conditions are found:

(i) The maximum high groundwater level must be at least one foot below the original ground surface.

(ii) Bedrock shall be at least two feet below the natural ground surface.

(iii) The percolation rate of the naturally occurring soil shall be faster than 120 minutes/inch.

(iv) The natural ground slopes shall not exceed 12%.

(v) All minimum horizontal separation distances can be maintained as described in Table 2.

(3) Design Criteria.

(i) The designer shall consult with the health unit having jurisdiction regarding the method for detailing the hydraulic design.

(ii) The basal area of a mound system is defined differently than a raised bed. The basal area for a system on level ground includes all the area beneath the absorption trenches or bed and the area under the tapers. On a sloping site, the basal area includes only the area under the absorption trenches/bed and the lower or downhill taper. The basal area is designed upon the percolation of the naturally occurring soil. Where the percolation rate is 60 min/in or faster, refer to Table 4B. For soils of 61 to 120 min/in, a rate of 0.2 gpd/sq.ft. shall be used for determining the minimum basal area required.

(iii) Percolation tests for the fill material shall be conducted at the borrow pit. Only soils with a percolation rate between five and 30 minutes per inch shall be used for the fill material. Sands with greater than 10% by weight finer than 0.05 mm material must be avoided. At least 25% of the material by weight shall be in the range of 0.50 mm to 2.0 mm. Less than 15% of the material by weight shall be larger than a half-inch sieve. A sieve analysis may be necessary to verify this requirement. The required absorption area is based upon the percolation rate of the fill material as determined from Table 4B.

(iv) The system shall be designed to run parallel with the contours of the site. The width of the system (up and down the slope) shall be kept to a minimum, but in no case shall the absorption area be wider than 20 feet. In a distribution network using a center pressure manifold, distribution lines shall have a maximum total length of 200 feet. In a network using an end manifold, distribution lines shall

have a maximum length of 100 feet.

(v) Mound dimensions shall meet or exceed those required by the health unit having jurisdiction.

(vi) A pressure distribution network shall be required.

(vii) A dual chamber septic tank or two tanks in series in addition to the dosing tank shall be provided. A gas baffle or other outlet modification that enhances solids retention is recommended.

(4) Construction.

(i) Heavy construction equipment shall not be allowed within the basal area and area downslope of the system which will act as the dispersal area for the mound.

(ii) The vegetation shall not be scraped away, roto-tilled, or compacted. Excess vegetation shall be removed with trees cut at the ground surface but stumps left in place. The area shall be plowed to a depth of seven or eight inches with a double bottomed blade/furrow plow and the furrow turned upslope.

(iii) The fill material is placed from the upslope side of the system to the full depth required in the design and shall extend to the edge of the basal area at a slope not to exceed one vertical to three horizontal.

(iv) The absorption area is then formed within the mound. A minimum of six inches of aggregate shall be placed beneath the distribution lines.

(v) The pressure distribution lines are placed parallel to the contours of the slope and a minimum of two inches of aggregate is placed above the lines.

(vi) A permeable geotextile is placed over the entire absorption area to prevent the infiltration of fines into the aggregate.

(vii) On sloping sites a diversion ditch or curtain drain shall be installed uphill to prevent surface water runoff from reaching the absorption area.

(viii) A minimum of six inches of finer materials such as clayey loam is placed over the top of the absorption area, and the entire mound including the tapers is then covered with six inches of top soil and seeded to grass.

(d) Intermittent Sand Filters.

(1) General. In a sand filter, the septic tank or aerobic unit effluent is intermittently spread across the surface of a bed of sand through a network of distribution lines. Collector pipes beneath the filter collect treated effluent after it has passed through the sand.

(2) Site Requirements.

(i) All horizontal separation distances shown in Table 2 must be met and the minimum required vertical separation to groundwater must be met from the bottom of the collector pipes.

(ii) An environmental assessment determines that the development of the site with a sand filter is consistent with the overall development of the area and will cause no adverse environmental impacts.

(3) Design Criteria.

(i) Septic tanks installed before a sand filter shall have dual compartments or two tanks in series. The use of a gas baffle on the outlet is strongly recommended.

(ii) The direct discharge of sand filter effluent to the ground surface or to a body of water shall not be approved by the Department of Health or a local health department acting as its agent.

(iii) Distributor lines shall be placed at three foot center lines as level as possible.

(iv) Collector pipes shall be centered between distribution lines at a slope of 1/16 to 1/8 inch per foot.

(v) Effluent shall be distributed to the sand filter by means of pressure distribution or dosing (siphon or pump). Gravity distribution may be used to apply effluent to smaller filters having less than 300 lineal feet of 4-inch diameter distributors or less than 900 square feet of filter area. Pressure distribution lines shall be a minimum of 1-inch and a maximum of three inches in diameter. Pressure distribution pumps shall be selected to maintain a minimum pressure of one pound per square inch (2.3 feet of head) at a downstream end of each distribution line during the distribution cycle. If siphon or pump dosing is allowed, the distributor pipe(s) shall have a diameter of three to four inches.

(vi) The distribution system shall be designed to dose the filter at least three times daily based upon the design flow rates with each dose.

(vii) The sand media shall have an effective grain size of 0.25 to 1.0 mm. If nitrification is not required by the local health department, the effective grain size shall be in the range of 0.5 to 1.00 mm. All sand shall pass a 1/4 inch sieve.

(viii) The uniformity coefficient of the sand shall not exceed 4.0.

(ix) The maximum allowed daily sand loading rate shall be 1.15 gal/day/sq. ft.

(x) Effluent from the collector pipes shall be discharged to an absorption bed located below the original ground level or a mound that is built up above the original ground surface. The size of the bed/mound shall be based upon the estimated quantity of effluent reaching the collector pipe and an application rate of 1.2 gal/day/sq.ft. regardless of the underlying soil percolation. The fill material for the bed/mound shall consist of medium sand with a percolation rate, tested at the borrow pit, not faster than five minutes per inch. All minimum vertical and horizontal separation distances shall be maintained as described in Section 75-A.4.

(4) Construction.

(i) After excavation, the collector pipe shall be placed in 3/4 inches to 1 1/2 inches size aggregate.

(ii) There shall be a minimum of four inches of this aggregate beneath the entire system above the collectors.

(iii) A three inch layer of crushed stone or clean gravel with a size of 1/8 inches to 1/4 inches is carefully placed on top of the aggregate.

(iv) A minimum of 24 inches of the approved sand is placed above the crushed stone or gravel.

(v) The distributor pipes are placed in a layer of aggregate that provides a minimum of four inches across the entire surface of the filter and at least two inches above and below the distributor pipes.

(vi) A permeable geotextile, two inches of hay or straw, or untreated building paper is placed over the entire bed area to prevent the infiltration of fines into the filter.

(vii) The entire surface of the filter shall be covered with six to 12 inches of topsoil, mounded to enhance the runoff of rainwater from the system and seeded to grass.

(viii) The bed/mound following the filter shall be covered with six to 12 inches of topsoil and seeded to grass.

(e) Evaporation-Transpiration (ET) and Evapo-Transpiration Absorption (ETA) Systems.¹

(1) General. ET systems rely on the upward movement of moisture through the soil, surface vegetation and into the air rather than absorption into the soil. ETA systems also use the absorptive capabilities of the soil and are less dependent on evaporation and transpiration.

(2) Site Requirements.

(i) All systems previously discussed, except intermittent sand filters, have been determined to be unacceptable for the planned building site.

(ii) An expansion area equal to or greater than 50% of the required basal area shall be available on the site.

(iii) All minimum vertical and horizontal separation distances can be maintained as described in Table 2 from both the edges of the basal area and the designated expansion area.

(iv) An environmental assessment determines that the development of the site with this system is consistent with the overall development of the area and will cause no adverse environmental impacts.

(3) Design Criteria.

(i) The designer must consider all of the items listed below and be able to document from reliable sources (i.e., National Weather Service, Soil Conservation Service) the parameters used and show that the net outflow from the system exceeds the inflow without the exposure of sewage or partially treated sewage on the surface of the ground:

Total rainfall and snowfall.

The percentage of the rainfall and snowfall that will infiltrate into the soil and the percentage that can be expected to runoff the system.

The annual land evaporation rate of the area.

The vertical rise of water than can be expected in the soil due to capillary action.

The amount of transpiration expected from the surface vegetation.

The permeability of the underlying soil and the impact the system will have on the groundwater level.

(ii) The design must provide for a trench depth that is not greater than 30 inches below the surface.

(iii) Pressure distribution of effluent throughout the system is required.

¹ *Note: Section 75-A.9(e), Evaporation-Transpiration (ET) and Evapo-Transpiration Absorption (ETA) Systems, was unintentionally left in the officially amended regulation dated February 3, 2010. Until a future update to this Appendix is promulgated that will delete this section, it is recommended that these systems not be considered for design and installation.*

75-A.10 Other Systems.

(a) Holding Tanks. The use of holding tanks shall not be permitted for new home construction except where occupancy of a home is permitted while the sewage treatment system is under construction. Tank size shall be based upon five days design flow or 1,000 gallons, whichever is greater and meet the same construction as a septic tank except that the holding tank shall not have an outlet. Holding tanks are not acceptable for long term use on year-round residences.

(b) Non-Waterborne Systems.

(1) General. In certain areas of the State where running water is not available or is too scarce to economically support flush toilets, or where there is a need or desire to conserve water, the installation of non-waterborne sewage systems may be considered however, the treatment of wastewater from sinks, showers, and other facilities must be provided when non-flush toilets are installed. Household wastewater without toilet wastes is known as greywater.

(2) Composters. These units shall be installed in accordance with the manufacturers instructions. The units shall have a label indicating compliance with the requirements of National Sanitation Foundation (NSF) Standard 41 or equivalent. Only units with a warranty of five years or more shall be installed.

(3) Chemical and Recirculating Toilets.

(i) Chemical toilets provide a toilet seat located directly above a vault containing chemicals to disinfect and remove odors from the wastewater. Recirculating toilets use chemicals as the toilet flush fluid. The wastes are separated from the fluid, wastes discharged to an internal holding tank, and the fluid reused.

(ii) The liquids used in these types of toilets do not completely disinfect the wastes; therefore, waste products from these units shall not be discharged to

surface waters or to the ground surface.

(iii) The reduced volume wastewater from recirculating toilets may be discharged to a larger holding tank but not to a subsurface absorption system.

(4) Incinerator Toilets. These units accept human waste into a chamber where the wastes are burned. They have a very limited capacity and require a source of electricity or gas. The ash remains must be periodically removed. They must be installed according to the manufacturer's instructions.

(5) Greywater Systems. Greywater systems shall be designed upon a flow of 75 gpd/bedroom and meet all the criteria previously discussed for treatment of household wastewater.

(c) Engineered Systems.²

(1) A treatment system of a type not discussed in this document may be allowed only through the issuance of a Specific Waiver by the health unit having jurisdiction as provided for in Part 75, of this Title.

(2) Special Conditions.

(i) The system shall be designed by a design professional.

(ii) An environmental assessment determines that the development of the site with this system is consistent with the overall development of the area and will cause no adverse environmental impacts. The homeowner/purchaser shall be informed of the expected reliability or problems with the design.

(iii) The design professional supervises the installation of the system and certifies that the system was built in accordance with the approved plan and/or submits as-built plans of the system.

² Note: Section 75-A.10(c), Engineered Systems, was unintentionally left in the officially amended regulation dated February 3, 2010. Until a future update to this Appendix is promulgated that will delete this section, it is recommended that these systems not be considered for design and installation.

75-A.11 Specific Waivers.

Deviations from these standards may be granted by the State Commissioner of Health or the designated full-time city, county or part-county health department official by issuance of a Specific Waiver in accordance with 10NYCRR Part 75, Section 75.6(b) of this Title.

NOTES:

TYPICAL LAYOUT OF A SUBSURFACE TILE SYSTEM

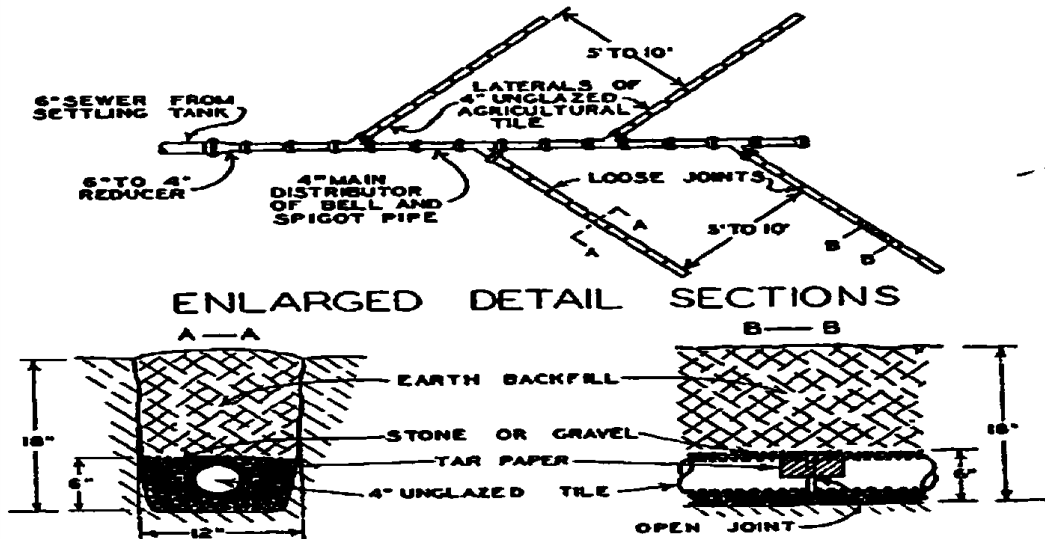

ALTERNATE LAYOUT OF A SUBSURFACE TILE SYSTEM

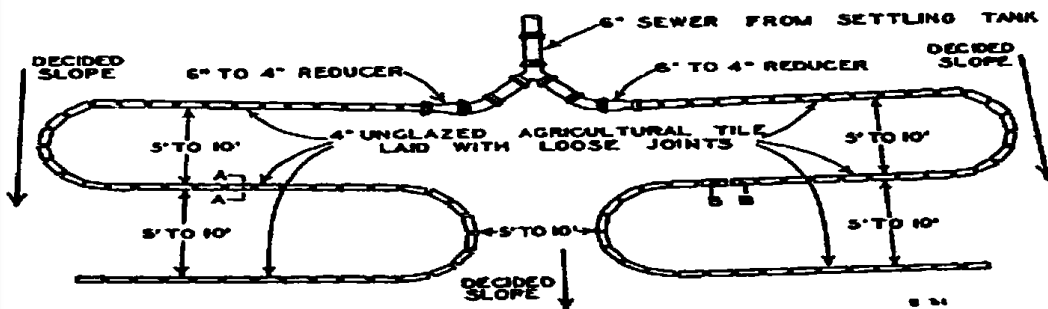

FIGURE 10

“Rural Water Supply and Sewage Disposal Systems”

C.A. Holmquist, Director, Division of Sanitation

NYSDOH

1932

This diagram is for historical interest only. Do not use for plan or design preparation



New York State Department of Health
Bureau of Water Supply Protection